

C 230 Kompressor Sport

C 240

C 240 4MATIC

C 320

C 320 4MATIC

C 320 Sport

C 32 AMG

Our company and staff congratulate you on the purchase of your new Mercedes-Benz.

Your selection of our product is a demonstration of your trust in our company name. Furthermore, it exemplifies your desire to own an automobile that will be as easy as possible to operate and provide years of service.

Your Mercedes-Benz represents the efforts of many skilled engineers and craftsmen. To help assure your driving pleasure, and also the safety of you and your passengers, we ask you to make a small investment of time:

- Please read this manual carefully, then return it to your vehicle where it will be handy for your reference.
- Please follow the recommendations contained in this manual. They are designed to acquaint you with the operation of your Mercedes-Benz.
- Please pay attention to the warnings and cautions contained in this manual. They are designed to help improve the safety of the vehicle operator and occupants.

We extend our best wishes for many miles of safe, pleasurable driving.

Mercedes-Benz USA, LLC
A DaimlerChrysler Company

Contents

Introduction	9	At a glance	19	Getting started	29
Product information	9	Cockpit	20	Unlocking	30
Operator's Manual	10	Instrument cluster	22	Unlocking with the SmartKey	30
Service and warranty information ..	10	Multifunction steering wheel	24	Adjusting	32
Important notice for California		Center console	25	Seats	32
retail buyers and lessees of		Upper part	25	Steering wheel	36
Mercedes-Benz automobiles	11	Lower part	26	Mirrors	38
Maintenance	12	Overhead control panel	27	Driving	40
Roadside Assistance	12	Door control panel	28	Fastening the seat belt	40
Change of address or ownership ...	12			Starting the engine	43
Operating your vehicle outside				Switching on headlamps	46
the USA or Canada	13			Turn signals and high beam	47
Where to find it	14			Windshield wipers	47
Symbols	15			Problems while driving	49
Operating safety	16			Parking and locking	50
Proper use of the vehicle	16			Parking brake	50
Problems with your vehicle	17			Switching off headlamps	51
Reporting safety defects	18			Turning off engine	52
Reporting Safety Defects	18				

Contents

Safety and Security	53	Controls in detail	81	Lighting	102
Occupant safety.....	54	Locking and unlocking.....	82	Exterior lamp switch	102
Airbags.....	55	SmartKey	82	Combination switch	105
Seat belts.....	60	Opening the doors from		Hazard warning flasher	106
Children in the vehicle.....	63	the inside	85	Interior lighting	107
Blocking of rear door window		Opening the trunk	86	Door entry lamps	108
operation.....	70	Closing the trunk.....	87	Trunk lamp.....	108
Panic alarm*	71	Trunk lid emergency release	88	Instrument cluster	109
Activating	71	Separately locking the trunk	89	Instrument cluster illumination	109
Deactivating	71	Separately unlocking the trunk	90	Coolant temperature display.....	110
Driving safety systems.....	72	Automatic central locking	90	Trip odometer	111
ABS	72	Locking and unlocking from		Tachometer.....	111
BAS	73	the inside	91	Outside temperature indicator	111
ESP.....	74	Seats	92	Control system	113
Four wheel electronic traction		Easy-entry/exit feature*	92	Multifunction display.....	113
system (4MATIC) with the ESP	77	Removing and installing front seat		Multifunction steering wheel.....	114
Anti-theft systems.....	78	head restraints.....	93	Menus	116
Immobilizer.....	78	Rear seat head restraints	94	Standard display menu	118
Anti-theft alarm system*	78	Multicontour seat*	97	AUDIO menu	118
Tow-away alarm*	79	Heated seats*	98	NAVI* menu.....	121
		Memory function*	99	Malfunction memory menu	122
		Storing positions into memory	100	Settings menu.....	123
		Recalling positions from memory	100	Trip computer menu.....	136
		Storing exterior rear view mirror		TEL menu*	138
		parking position	101		

Contents

Manual transmission	141	Ventilated storage compartment ..	160	Power windows	200
Shifting into reverse	141	Rear passenger compartment		Opening and closing	
Automatic transmission*	142	adjustable air vents.....	161	the windows	200
One-touch gearshifting.....	143	Automatic climate control*	162	Synchronizing power windows.....	202
Gear ranges	144	Setting the temperature.....	165	Sliding/pop-up roof*	203
Gear selector lever position	145	Adjusting air distribution.....	166	Opening and closing	
Program mode selector switch.....	146	Adjusting air volume	166	the sliding/pop-up roof	203
Accelerator position.....	147	Maximum cooling MAXCOOL.....	167	Synchronizing	
Emergency operation		Defrosting	167	the sliding/pop-up roof	205
(Limp Home Mode)	147	Air recirculation mode	167	Driving systems.....	206
Good visibility	148	Charcoal filter	169	Cruise control	206
Windshield wipers	148	Air conditioning.....	170	Loading	209
Headlamp cleaning system*	148	Residual heat and ventilation.....	171	Roof rack*	209
Rear view mirrors.....	149	Rear passenger compartment		Ski sack*	209
Sun visors	151	adjustable air vents.....	172	Split rear bench seat*	212
Rear window sunshade*	152	Audio system.....	173	Loading instructions	214
Rear window defroster	153	Audio and telephone, operation... ..	173	Useful features.....	216
Climate control.....	154	Operating safety	173	Interior storage spaces.....	216
Setting the temperature.....	156	Operating and display elements... ..	174	Ashtrays.....	220
Adjusting air distribution and		Button and soft key operation.....	176	Cigarette lighter	221
volume	157	Operation.....	176	Telephone*	222
Defrosting	158	Radio operation	179	Tele Aid*	223
Air recirculation mode.....	158	Satellite radio (SAT)* (USA only)... ..	182	Garage door opener.....	231
Deactivating the climate control		Cassette operation	186		
system	159	CD changer* operation	189		
Air conditioning.....	160	Telephone* operation	193		

Contents

Operation	237	At the gas station	249	Winter driving	263
The first 1000 miles (1500 km).....	238	Refueling	249	Winter tires	263
Driving instructions.....	239	Check regularly and before		Block heater (Canada only)	264
Drive sensibly – save fuel	239	a long trip.....	251	Snow chains.....	264
Drinking and driving	239	Engine compartment	252	Maintenance.....	265
Pedals	239	Hood	252	Clearing the service indicator	265
Power assistance	239	Engine oil	253	Service term exceeded	265
Brakes	240	Transmission fluid level.....	256	Calling up the service indicator....	266
Driving off.....	241	Coolant level	257	Resetting the service indicator	266
Parking	241	Battery	258	Vehicle care.....	267
Tires	242	Windshield washer system and		Cleaning and care of the vehicle..	267
Hydroplaning.....	242	headlamp cleaning system*	259		
Tire traction.....	243	Tires and wheels.....	260		
Tire speed rating	243	Important guidelines	260		
Winter driving instructions	244	Life of tire.....	261		
Standing water	245	Direction of rotation	261		
Passenger compartment	246	Checking tire inflation pressure ...	261		
Driving abroad.....	246	Rotating wheels	262		
Control and operation of radio					
transmitters.....	246				
Catalytic converter	247				
Emission control.....	247				
Coolant temperature	248				

Contents

Practical hints	273	Replacing bulbs	310	Jump starting.....	326
What to do if	274	Bulbs.....	310	Towing the vehicle.....	328
Lamps in instrument cluster	274	Replacing bulbs for front lamps	312	Installing towing eye bolt.....	331
Lamp in center console.....	279	Side marker lamp bulb.....	314	Fuses.....	332
Messages in the display.....	280	Replacing bulbs for rear lamps	315	Fuse box in	
Where will I find ...?	300	Replacing wiper blades.....	316	passenger compartment.....	332
First aid kit.....	300	Removing wiper blades.....	316	Fuse box in engine compartment .	333
Vehicle tool kit.....	300	Installing wiper blades	316	Auxiliary fuse box in trunk	334
Minispare wheel.....	302	Flat tire.....	317		
Unlocking/locking in an emergency..	305	Preparing the vehicle	317		
Unlocking the vehicle.....	305	Mounting the Minispare wheel.....	317		
Locking the vehicle	306	Battery.....	323		
Changing batteries in		Disconnecting the battery.....	324		
the SmartKey	307	Removing the battery.....	324		
Fuel filler flap	308	Charging and reinstalling			
Manually unlocking the		the battery	324		
transmission gear selector lever ..	308	Reconnecting the battery.....	325		
Opening/closing in an emergency.....	309				
Sliding/pop-up roof*	309				

Contents

Technical data	335	Fuels, coolants, lubricants, etc.	349	Technical terms	361
Spare parts service	336	Capacities	349		
Warranty coverage	337	Engine oils.....	352		
Loss of Service and Warranty		Engine oil additives	352	Index	367
Information Booklet.....	337	Air conditioning refrigerant	352		
Identification labels.....	338	Brake fluid.....	352		
Layout of poly-V-belt drive	339	Premium unleaded gasoline	353		
C 230 Kompressor Sport.....	339	Fuel requirements	353		
C 240/C 320 (all models)	339	Gasoline additives	354		
C 32 AMG.....	339	Flexible Fuel Vehicles.....	354		
Engine	340	Coolants.....	356		
Rims and Tires	342	Windshield washer and headlamp			
Same size tires	343	cleaning* system	358		
Mixed size tires	344	Consumer information.....	359		
Minispare wheel	345	Uniform tire quality grading	359		
Electrical system.....	346				
Main dimensions.....	347				
Weights.....	348				

▼ **Product information**

Please observe the following in your own best interest:

We recommend using genuine Mercedes-Benz parts as well as conversion parts and accessories explicitly approved by us for your vehicle model.

We have tested these parts to determine their reliability, safety and special suitability for Mercedes-Benz vehicles.

We are unable to make an assessment for other products and therefore cannot be held responsible for them, even if in individual cases an official approval or authorization by governmental or other agencies should exist. Use of such parts and accessories could adversely affect the safety, performance or reliability of your vehicle. Please do not use them.

Genuine Mercedes-Benz parts as well as conversion parts and accessories approved by us are available at your authorized Mercedes-Benz Center where you will receive comprehensive information, also on permissible technical modifications, and where proper installation will be performed.

Introduction

Operator's Manual

▼ Operator's Manual

This Operator's Manual contains a great deal of useful information. We urge you to read it carefully and familiarize yourself with the vehicle before driving.

For your own safety and longer service life of the vehicle, we urge you to follow the instructions and warnings contained in this manual. Ignoring them could result in damage to the vehicle or personal injury to you or others. Vehicle damage caused by failure to follow instructions is not covered by the Mercedes-Benz Limited Warranty.

Your vehicle may have some or all of the equipment described in this manual. Therefore, you may find explanations for optional equipment not installed in your vehicle. If you have any questions about the operation of any equipment, your authorized Mercedes-Benz Center will be glad to demonstrate the proper procedures.

We continuously strive to improve our product, and ask for your understanding that we reserve the right to make changes in design and equipment. Therefore, information, illustrations and descriptions in this Operator's Manual might differ from your vehicle.

Optional equipment is also described in this manual, including operating instructions wherever necessary. Since they are special-order items, the descriptions and illustrations herein may vary slightly from the actual equipment of your vehicle.

If there are any equipment details that are not shown or described in this Operator's Manual, your authorized Mercedes-Benz Center will be glad to inform you of correct care and operating procedures.

The Operator's Manual and Service Booklet are important documents and should be kept with the vehicle.

Service and warranty information

The Service and Warranty Information Booklet contains detailed information about the warranties covering your Mercedes-Benz, including:

- New Car Limited Warranty
- Emission System Warranty
- Emission Performance Warranty
- California, Maine, Massachusetts, and Vermont Emission Control System Warranty (California, Maine, Massachusetts, and Vermont only)
- State Warranty Enforcement Laws (Lemon Laws)

Important notice for California retail buyers and lessees of Mercedes-Benz automobiles

Under California law you may be entitled to a replacement of your vehicle or a refund of the purchase price or lease price, if Mercedes-Benz USA, LLC and/or its authorized repair or service facilities fail to fix one or more substantial defects or malfunctions in the vehicle that are covered by its express warranty after a reasonable number of repair attempts. During the period of 18 months from original delivery of the vehicle or the accumulation of 18000 miles (approx. 29000 km) on the odometer of the vehicle, whichever occurs first, a reasonable number of repair attempts is presumed for a retail buyer or lessee if one or more of the following occurs:

- (1) the same substantial defect or malfunction results in a condition that is likely to cause death or serious bodily injury if the vehicle is driven, that defect or malfunction has been subject to repair two or more times, and you have directly notified Mercedes-Benz USA, LLC in writing of the need for its repair,
- (2) the same substantial defect or malfunction of a less serious nature than category (1) has been subject to repair four or more times and you have directly notified us in writing of the need for its repair, or
- (3) the vehicle is out of service by reason of repair of the same or different substantial defects or malfunctions for a cumulative total of more than 30 calendar days. Written notification should be sent to us, not a dealer, at Mercedes-Benz USA, LLC, Customer Assistance Center, One Mercedes Drive, Montvale, NJ 07645-0350.

Introduction

Operator's Manual

Maintenance

The Service Booklet describes all the necessary maintenance work which should be performed at regular intervals.

Always have the Service Booklet with you when you take the vehicle to your authorized Mercedes-Benz Center for service. The service advisor will record each service in the booklet for you.

Roadside Assistance

The Mercedes-Benz Roadside Assistance Program provides factory-trained technical help in the event of a breakdown. Calls to the toll-free Roadside Assistance number

1-800-FOR-MERCEdes (in the USA)
1-800-387-0100 (in Canada)

will be answered by Mercedes-Benz Customer Assistance Representatives 24 hours a day, 365 days a year.

For additional information refer to the Mercedes-Benz Roadside Assistance Program Brochure in your glove box.

Change of address or ownership

If you change your address, be sure to send in the "Change of Address Notice" found in the Service and Warranty Information Booklet, or simply call the Mercedes-Benz Customer Assistance Center (in the USA) at 1-800-FOR-MERCEdes, or Customer Service (in Canada) at 1-800-387-0100. It is in your own interest that we can contact you should the need arise.

If you sell your Mercedes, please leave all literature with the vehicle to make it available to the next operator.

If you bought this vehicle used, be sure to send in the "Notice of Purchase of Used Car" found in the Service and Warranty Information Booklet, or call the Mercedes-Benz Customer Assistance Center (in the USA) at 1-800-FOR-MERCEdes, or Customer Service (in Canada) at 1-800-387-0100.

Operating your vehicle outside the USA or Canada

If you plan to operate your vehicle in foreign countries, please be aware that

- service facilities or replacement parts may not be readily available,
- unleaded gasoline for vehicles with catalytic converters may not be available; the use of leaded fuels will damage the catalyts,
- gasoline may have a considerably lower octane rating, and improper fuel can cause engine damage.

Certain Mercedes-Benz models are available for delivery in Europe under our European Delivery Program. For details, consult your authorized Mercedes-Benz Center or write to:

In the USA:

Mercedes-Benz USA, LLC
European Delivery Department
One Mercedes Drive
Montvale, NJ 07645-0350

In Canada:

Mercedes-Benz Canada, Inc.
European Delivery Department
849 Eglinton Avenue East
Toronto, Ontario M4G 2L5

Introduction

Where to find it

▼ Where to find it

This Operator's Manual is designed to provide comprehensive support information for you, the vehicle operator. Each section has its own reference color so you can find information quickly.

At a glance

Here you will find an overview of all the controls that can be operated from the driver's seat.

Getting started

Here you will find all the information you need for your first drive. You should read this section first if this is your first Mercedes-Benz vehicle or if you are renting or borrowing this vehicle.

Safety and Security

Here you will find descriptions of the safety features of your vehicle.

Controls in detail

Here you will find detailed information about the equipment installed in your vehicle. This section expands on the "Getting started" section and also describes technical innovations. If you are already familiar with the basic functions of your vehicle, this section will be of particular interest to you.

Operation

Here you will find all the information you need for the proper operation of your vehicle.

Practical hints

This section provides fast assistance for dealing with problems you may encounter.

Technical data

All important technical data for your vehicle can be found in this section.

Indexes

The glossary provides explanations of the most important technical terms.

The table of contents and the index are designed to help you find information quickly and easily.

The following publications are part of your vehicle documentation:

- this Operator's Manual
- the Service Booklet

Separate operating instructions will be provided as required depending on the equipment options installed in your vehicle.

▼ Symbols

The following symbols are found in this Operator's Manual:

- * Optional equipment is identified with an asterisk. Since standard equipment varies between models, the descriptions and illustrations in this manual may differ slightly from the actual equipment of your vehicle.

Warning!



Warning notices draw your attention to hazards that may endanger your health or life, or the health or life of others.



Highlights hazards that may result in damage to your vehicle.



Helpful hints or further information you may find useful.

- ▶ This symbol points to instructions for you to follow.
- ▶ A number of these symbols appearing in succession indicates a multiple-step procedure.
- ▷ Page This symbol tells you where to look for further information on a topic.
- ▷▷ This continuation symbol marks an interrupted procedure which will be continued on the next page.
- > In the glossary of technical terms, this symbol is used to indicate cross-references to term definitions.
- Display Words appearing in the multi-function display are printed in the type shown here.

Introduction

Operating safety

▼ Operating safety

Warning!



Work improperly carried out on electronic components and associated software could cause them to cease functioning. Because the vehicle's electronic components are interconnected, any modifications made may produce an undesired effect on other systems. Electronic malfunctions could seriously impair the operating safety of your vehicle.

See your authorized Mercedes-Benz Center for repairs or modifications to electronic components.

Other improper work or modifications on the vehicle could also have a negative impact on the operating safety of the vehicle.

Some safety systems only function while the engine is running. You should therefore never turn off the engine while driving.

Warning!



Heavy blows against the vehicle underbody or tires/wheels, for example when running over an obstacle, road debris or a pothole, may cause serious damage and impair the operating safety of your vehicle. If you feel a sudden significant vibration or ride disturbance, or you suspect that damage to your vehicle has occurred, you should turn on your hazard warning flashers, carefully slow down, and drive with caution to an area which is a safe distance from the road.

Inspect the vehicle underbody and tires/wheels for possible damage. If the vehicle appears unsafe, have it towed to the nearest authorized Mercedes-Benz Center or other qualified maintenance or repair facility for further inspection or repairs.

Proper use of the vehicle

Proper use of the vehicle requires that you are familiar with the following information and rules:

- the safety precautions in this manual
- the “Technical data” section in this manual
- traffic rules and regulations
- motor vehicle laws and safety standards

Warning!



Various warning labels are attached to your vehicle. These warning labels are intended to make you and others aware of various risks. You should not remove any of these warning labels unless explicitly instructed to do so by information on the label itself. Removal of any of these labels may cause you and others to be unaware of certain risks which may result in an accident and/or personal injury.

▼ **Problems with your vehicle**

If you should experience a problem with your vehicle, particularly one that you believe may affect its safe operation, we urge you to immediately contact your authorized Mercedes-Benz Center to have the problem diagnosed and corrected if required. If the matter is not handled to your satisfaction, please discuss the problem with the Mercedes-Benz Center management, or if necessary contact us at one of the following addresses:

In the USA:

Customer Assistance Center
Mercedes-Benz USA, LLC
One Mercedes Drive
Montvale, NJ 07645-0350

In Canada:

Customer Relations Department
Mercedes-Benz Canada, Inc.
849 Eglinton Avenue East
Toronto, Ontario, M4G 2L5

Introduction

Reporting safety defects

▼ Reporting safety defects

For the USA only:

The following text is published as required of manufacturers under Title 49, Code of U.S. Federal Regulations, Part 575 pursuant to the “National Traffic and Motor Vehicle Safety Act of 1966”.

Reporting Safety Defects

If you believe that your vehicle has a defect which could cause a crash or could cause injury or death, you should immediately inform the National Highway Traffic Safety Administration (NHTSA) in addition to notifying Mercedes-Benz USA, LLC.

If NHTSA receives similar complaints, it may open an investigation, and if it finds that a safety defect exists in a group of vehicles, it may order a recall and remedy campaign. However, NHTSA cannot become involved in individual problems between you, your dealer, or Mercedes-Benz USA, LLC.

To contact NHTSA, you may either call the Auto Safety Hotline toll-free at 1-888-327-4236 (or 366-0123 in Washington, D.C. area) or write to: NHTSA, U.S. Department of Transportation, Washington, D.C. 20590. You can also obtain other information about motor vehicle safety from the Hotline.



At a glance

Cockpit

Instrument cluster

Multifunction steering wheel

Center console

Overhead control panel

Door control panel

At a glance

Cockpit

▼ Cockpit

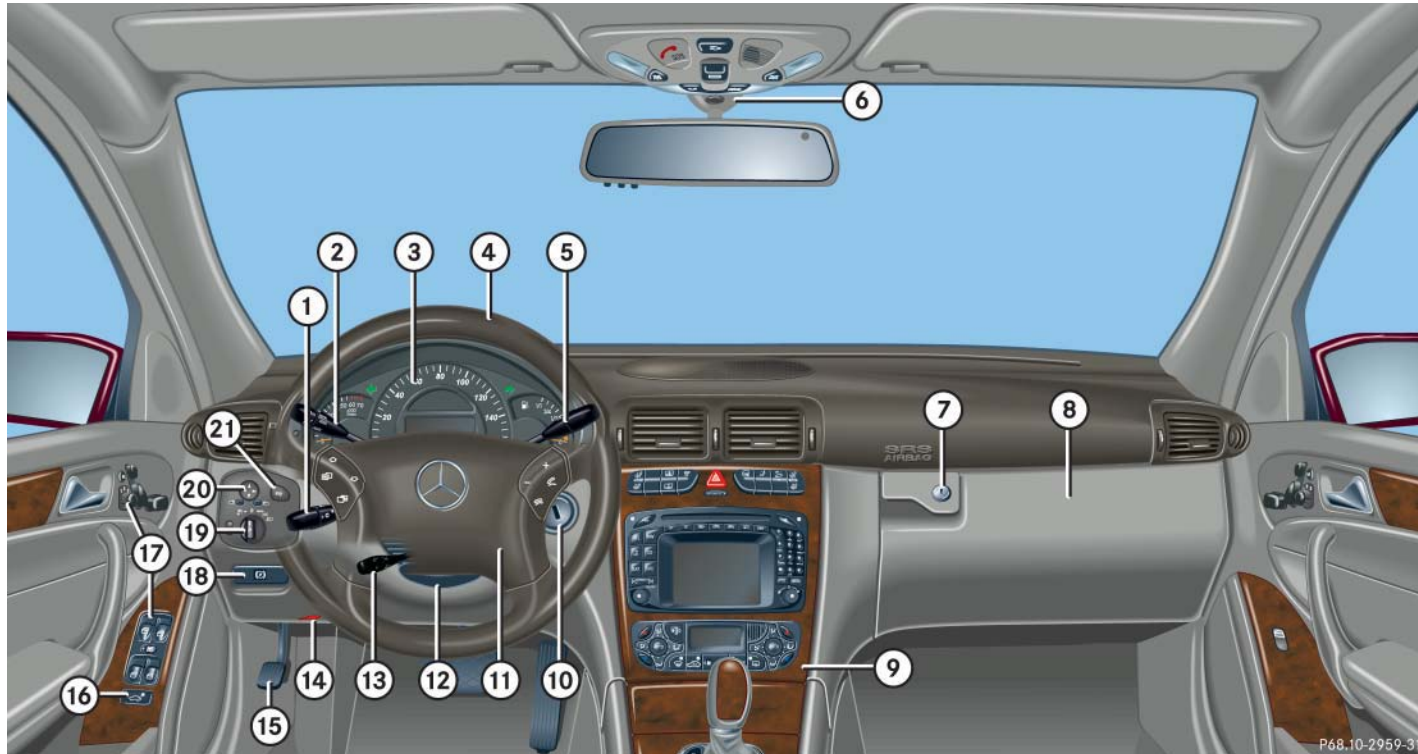

At a glance

Cockpit

	Item	Page
①	Combination switch	
	• Turn signals	47
	• Windshield wipers	47
	• High beam	47
②	Cruise control lever	206
③	Instrument cluster	22, 109
④	Multifunction steering wheel	24, 114
⑤	Lever for voice control system*, see separate operating instructions	

	Item	Page
⑥	Overhead control panel	27
⑦	Glove box lid release, glove box lock	216
⑧	Glove box	216
⑨	Center console	25
⑩	Starter switch	31
⑪	Horn	
⑫	Steering wheel adjustment handle (manual)	37
⑬	Steering wheel adjustment stalk (electrical)*	37

	Item	Page
⑭	Hood lock release	252
⑮	Parking brake pedal	45, 50
⑯	Trunk lid release switch	86
⑰	Door control panel	28
⑱	Parking brake release	45
⑲	Exterior lamp switch	102
⑳	Exterior rear view mirror adjustment	38
㉑	Headlamp washer switch*	148

At a glance

Instrument cluster



▼ Instrument cluster









P54.32-2183-31

At a glance

Instrument cluster

	Item	Page
①	Left turn signal indicator lamp	47
②	Speedometer	
③	Right turn signal indicator lamp	47
④	Fuel gauge with:	
	Fuel reserve warning lamp	278
⑤	 Seat belt non-usage warning lamp	60, 278
	 Supplemental restraint system indicator lamp	54, 278
⑥	Multifunction display with:	113
	Trip odometer	111
	Main odometer	113

	Item	Page
	Gear selector lever position	44, 145
	Program mode	146
	Outside temperature indicator	111
	Digital clock	113
⑦	 Engine malfunction indicator lamp	276
	 Electronic Stability Program (ESP) warning lamp	74, 277
	 High beam head-lamp indicator	47, 106
	 Indicator lamp without function ¹	
	DTR Indicator lamp without function ¹	

	Item	Page
⑧	 Antilock Brake System (ABS) indicator lamp	72, 274
	 Brake warning lamp, USA only	45, 50, 275
	 Brake warning lamp, Canada only	45, 50, 275
⑨	Tachometer	111
⑩	Reset button for:	
	• Resetting trip odometer	111
	• Resetting individual settings	124
	• Instrument cluster illumination	109

¹ The indicator lamp illuminates with SmartKey in starter switch position **2**. It should go out when the engine is running.

At a glance

Multifunction steering wheel

▼ Multifunction steering wheel

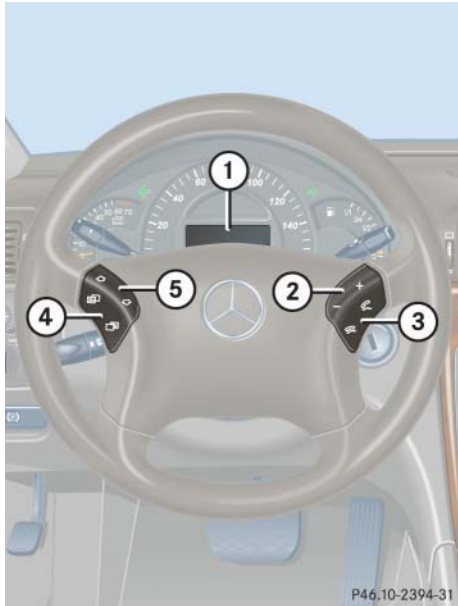

	Item	Page
①	Multifunction display in speedometer	113
	Operating control system	113
②	Selecting the submenu or setting the volume	
	— down/to decrease	
	+ up/to increase	
③	Telephone*: Press button	
	☎ to take a call	
	☎ to end a call	

	Item	Page
④	Menu systems: Press button	
	☞ for next system	
	☜ for previous system	
⑤	Moving within a menu: Press button	
	⬆ for next display	
	⬇ for previous display	

At a glance

Center console

▼ Center console

Upper part

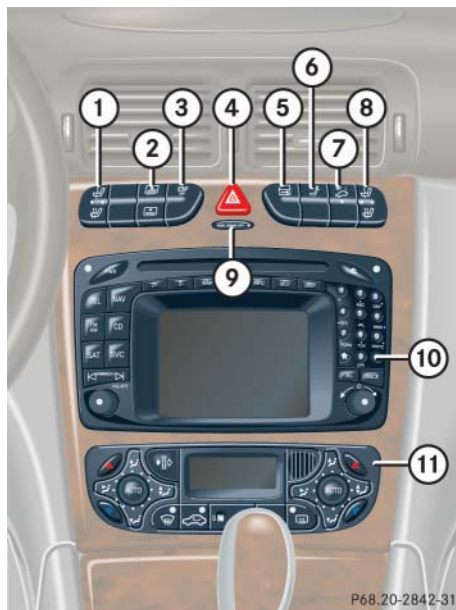

P68.20-2842-31

Item	Page
① Seat heater*, driver's side	98
② Rear window sunshade switch	152
③ ESP control switch	74
④ Hazard warning flasher switch - switching on/off	106
⑤ Central locking switch	91
⑥ Rear seat head restraints switch	95
⑦ Anti-theft alarm system indicator lamp	78
Tow-away alarm switch	79

Item	Page
⑧ Seat heater*, passenger side	98
⑨ PASS. AIRBAG OFF indicator lamp	66, 279
⑩ Audio system, or COMAND* (see separate operating instructions)	173
⑪ Climate control	154
Automatic climate control*	162
Rear window defroster	153

At a glance

Center console

Lower part



P68.20-2843-31

	Item	Page
①	Ashtray	220
②	Gear selector lever for automatic transmission*	44, 145
	Gearshift lever for manual transmission	43, 141
③	Storage compartment	218
	Cup holder	217
	Cigarette lighter	221
④	Armrest	219
⑤	Program mode selector for automatic transmission	146

▼ Overhead control panel



Item	Page
① Rear interior lighting on/off	108
② Sliding/pop-up roof*	203
③ Right reading lamp on/off	108
④ Interior lighting control	107
⑤ Hands-free microphone for Tele Aid* (emergency call system), telephone* and voice control system* (see separate operating instructions)	138, 193, 223
⑥ Interior rear view mirror	38, 149
⑦ Garage door opener	231
⑧ Left reading lamp on/off	108
⑨ Tele Aid* (emergency call system) button	223

At a glance

Door control panel

▼ Door control panel



	Item	Page
①	Door handle	85
②	Memory function* (for storing seat, exterior mirror and steering wheel settings)	99
③	Seat adjustment	32, 92
④	Switches for opening/closing front door windows	200
⑤	Switch for rear door window override	70
⑥	Switches for opening/closing rear door windows	200
⑦	Remote trunk lid switch	87

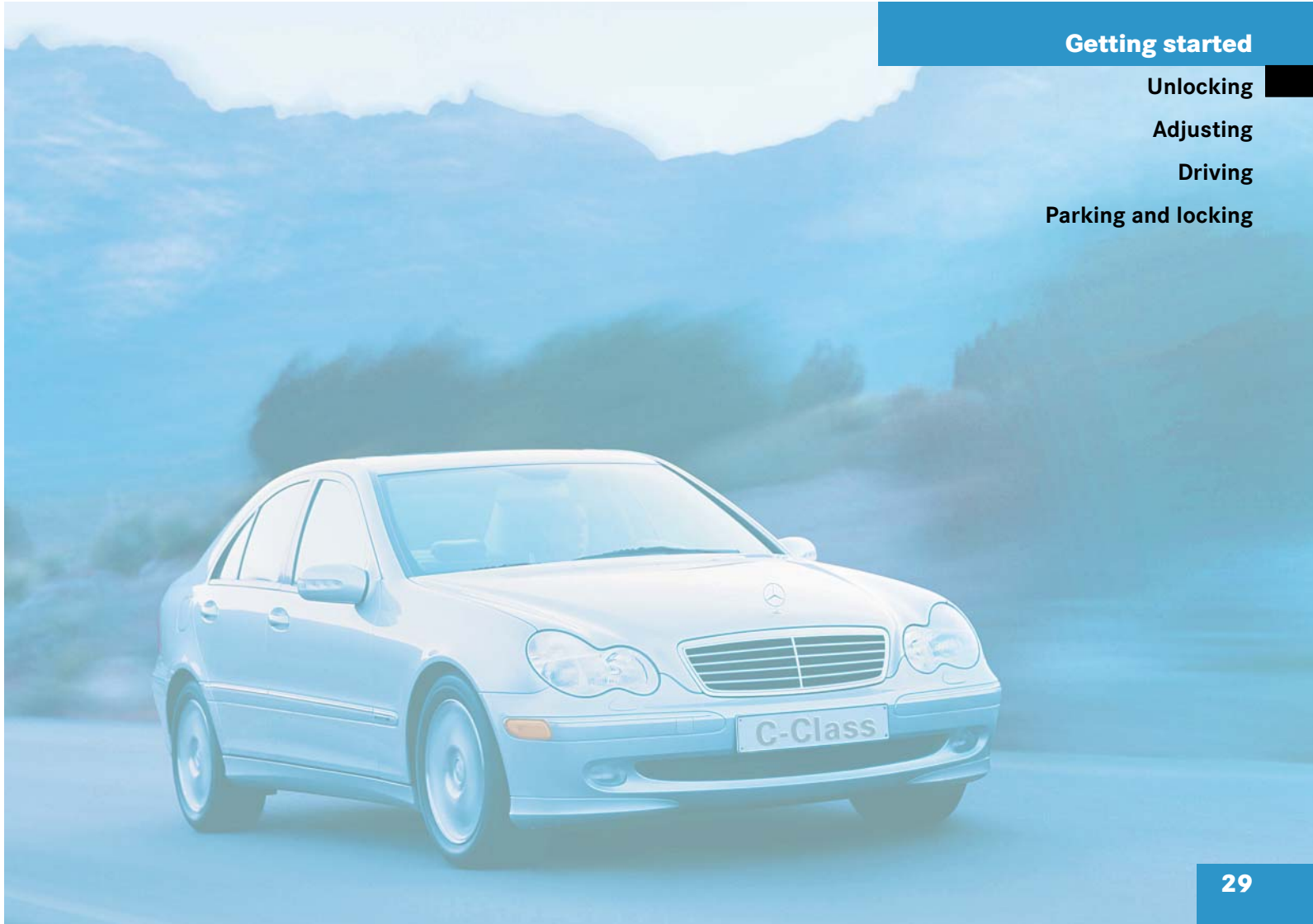

Getting started

Unlocking

Adjusting

Driving

Parking and locking

Getting started

Unlocking

The “Getting started” section provides an overview of the vehicle’s most basic functions. First-time Mercedes-Benz owners should pay special attention to the information given here.



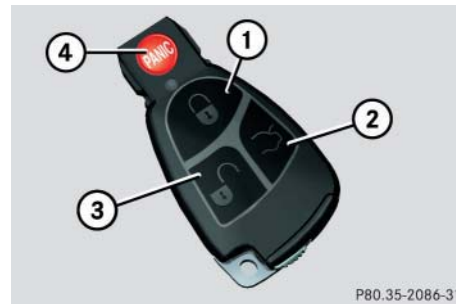

If you are already familiar with the basic functions described here, the “Controls in detail” section will provide you with further information. The corresponding page references are located at the end of each segment.

▼ Unlocking

Unlocking with the SmartKey



SmartKey with remote control

- ①  Lock button
- ②  Opening button for the trunk lid
- ③  Unlock button
- ④  Panic button* (▷ page 71)

i

Canada only:
Only vehicles equipped with an anti-theft alarm system* have SmartKeys with integrated panic button* ④.

- ▶ Press unlock button  on the SmartKey.

All turn signal lamps flash once. The locking knobs in the doors move up.

- ▶ Get in the vehicle and insert the SmartKey in the starter switch.

For more information, see “Locking and unlocking” (▷ page 82).

Starter switch positions



Starter switch

- 0** For removing SmartKey
The steering is locked when the SmartKey is removed from the starter switch. If necessary, move steering wheel slightly to allow the locking mechanism to engage.
- 1** Power supply to some electrical consumers, such as seat adjustment
- 2** Ignition (power supply for all electrical consumers) and driving position
- 3** Starting position

Warning!



When leaving the vehicle, always remove the SmartKey from the starter switch and lock the vehicle. Do not leave children unattended in the vehicle, or with access to an unlocked vehicle. Unsupervised use of vehicle equipment may cause an accident and/or serious personal injury.



Vehicles with automatic transmission:
The SmartKey can only be removed from the starter switch with the gear selector lever in position **P**.



If the SmartKey cannot be turned in the starter switch, the battery may not be sufficiently charged.

- Check the battery and charge it if necessary (▷ page 323).
- Get a jump start (▷ page 326).

To prevent accelerated battery discharge and a possible dead battery, always remove the SmartKey from the starter switch when the engine is not in operation.

Getting started

Adjusting

▼ Adjusting

Warning!



All seat, head restraint, steering wheel, and rear view mirror adjustments, as well as fastening of seat belts, must be done before the vehicle is put into motion.

Seats

The seats can be adjusted either manually or electrically, depending on the vehicle's equipment.

Warning!



Do not adjust the driver's seat while driving. Adjusting the seat while driving could cause the driver to lose control of the vehicle.

Never ride in a moving vehicle with the seat back reclined. Sitting in an excessively reclined position can be dangerous. You could slide under the seat belt in a collision. If you slide under it, the belt would apply force at the abdomen or neck.

That could cause serious or fatal injuries. The seat back and seat belts provide the best restraint when the wearer is in an upright position and belts are properly positioned on the body. Your seat must be adjusted so that you can correctly fasten your seat belt (▷ page 40).

Never place hands under the seat or near any moving parts while a seat is being adjusted.

Warning!



When leaving the vehicle, always remove the SmartKey from the starter switch, and lock your vehicle.

The power seats* can also be operated with the driver's or front passenger door open. Do not leave children unattended in the vehicle, or with access to an unlocked vehicle. Unsupervised use of vehicle equipment may cause an accident and/or serious personal injury.

Warning!



Children 12 years old and under must never ride in the front seat, except in a Mercedes-Benz authorized BabySmart™¹ compatible child seat, which operates with the BabySmart™ system installed in the vehicle to deactivate the passenger front airbag when it is properly installed. Otherwise they will be struck by the airbag when it inflates in a crash. If this happens, serious or fatal injury will result.

According to accident statistics, children are safer when properly restrained in the rear seating positions than in the front seating positions. Infants and small children must ride in back seats and be seated in an appropriate infant or child restraint system, which is properly secured with the vehicle's seat belt and top tether strap, or secured via lower anchors and top tether strap, fully in accordance with the child seat manufacturer's instructions.

¹ BabySmart™ is a trademark of Siemens Automotive Corp.

A child's risk of serious or fatal injuries is significantly increased if the child restraints are not properly secured in the vehicle and the child is not properly secured in the child restraint.

Manual seat adjustment

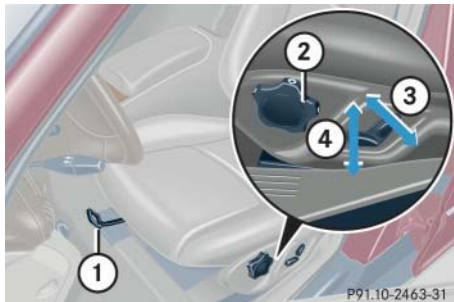

- ① Seat fore and aft adjustment
- ② Seat cushion tilt
- ③ Seat backrest tilt
- ④ Seat height

Seat fore and aft adjustment

- ▶ Lift handle ①.
- ▶ Slide seat to the desired position.
- ▶ Allow handle ① to reengage.
- ▶ Check for proper engagement before driving.

Adjust seat to a comfortable seating position that still allows you to reach the accelerator/brake pedal safely. The position should be as far rearward as possible, consistent with ability to properly operate controls.



When moving the seat, be sure that there are no items in the footwell or behind the seat. Otherwise you could damage the seat.

Seat cushion tilt

- ▶ Turn handwheel ② forward or backward until your upper legs are lightly supported

Seat backrest tilt

- ▶ Press switch ③ in direction of arrow until your arms are slightly angled when holding the steering wheel.

Seat height

- ▶ Press switch ④ in direction of arrow until your legs are lightly supported.

Getting started

Adjusting

Head restraint height

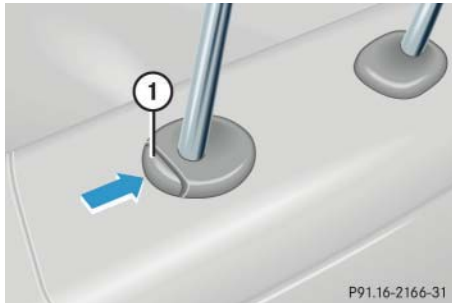

- ① Release button

Raising:

- ▶ Manually adjust the height of the head restraint by pulling it upward.

Lowering:

- ▶ To lower head the restraint, push release button ① and push down on the head restraint.

Warning!



For your protection, drive only with properly positioned head restraints.

Adjust head restraint so that the head restraint supports the back of the head at eye level. This will reduce the potential for injury to the head and neck in the event of an accident or similar situation.

Do not drive the vehicle without the seat head restraints. Head restraints are intended to help reduce injuries during an accident.

Head restraint tilt

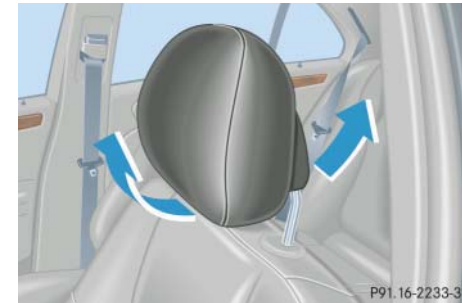

Manually adjust the angle of the head restraint.

- ▶ Push or pull on the lower edge of the head restraint cushion.

For more information, see “Seats” (▷ page 92).

Power seat* adjustment

The seat adjustment switches are located in each front door.

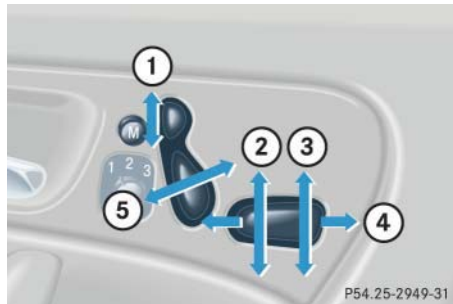

- ① Head restraint height
- ② Seat height
- ③ Seat cushion tilt
- ④ Seat fore and aft adjustment
- ⑤ Seat backrest tilt

► Turn the SmartKey in the starter switch to position **1** or **2** (► page 31).

or

► Open the driver's or front passenger door.

Seat fore and aft adjustment

► Press switch forward or backward in direction of arrow ④.

Adjust seat to a comfortable seating position that still allows you to reach the accelerator/brake pedal safely. The position should be as far rearward as possible, consistent with ability to properly operate controls.



When moving the seat, be sure that there are no items in the footwell or behind the seat. Otherwise you could damage the seat.

The memory function* (► page 99) lets you store the setting for the seat position together with the settings for the steering wheel and exterior rear view mirrors.

Seat cushion tilt

► Press switch up or down in direction of arrow ③ until your upper legs are lightly supported.

Seat backrest tilt

► Press switch forward or backward in direction of arrow ⑤ until your arms are slightly angled when holding the steering wheel.

Seat height

► Press switch up or down in direction of arrow ②.

Head restraint height

► Press switch up or down in direction of arrow ①.

Getting started

Adjusting

Warning!



For your protection, drive only with properly positioned head restraints.

Adjust head restraint so that the head restraint supports the back of the head at eye level. This will reduce the potential for injury to the head and neck in the event of an accident or similar situation.

Do not drive the vehicle without the seat head restraints. Head restraints are intended to help reduce injuries during an accident.

Head restraint tilt



Manually adjust the angle of the head restraint.

- ▶ Push or pull on the lower edge of the head restraint cushion.

For more information, see “Seats” (▷ page 92).

Steering wheel

Warning!



Do not adjust the steering wheel while driving. Adjusting the steering wheel while driving, or driving without the adjustment locked could cause the driver to lose control of the vehicle.

When leaving the vehicle, always remove the SmartKey from the starter switch and lock your vehicle.

The electrical steering wheel adjustment feature* can also be operated with the driver's door open. Do not leave children unattended in the vehicle, or with access to an unlocked vehicle. Unsupervised use of vehicle equipment may cause an accident and/or serious personal injury.

Steering wheel adjustment, manual

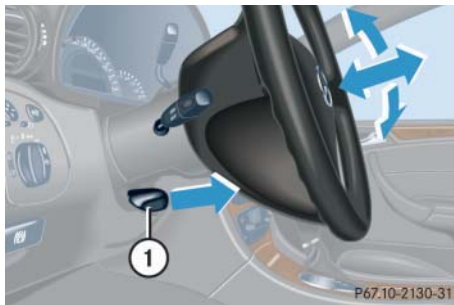

① Handle

- ▶ To unlock the steering column, pull handle ① out to its stop limit.
- ▶ Move steering wheel to the desired position.
- ▶ To lock the steering column, push handle ① all the way in until it engages.

The steering wheel is once again locked into position.



Do not drive the vehicle until you have properly locked the steering column.

If the warning message **STEERING WHEEL ADJ. - LOCK!** (▷ page 298) is displayed while the engine is running, the steering column is not locked.

Steering wheel adjustment, electrical*

The stalk for steering wheel adjustment is located on the steering column (lower left).

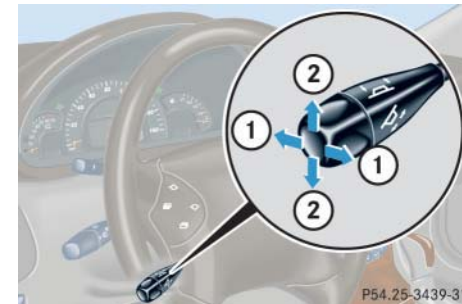

- ① Adjusting steering column, in or out
- ② Adjusting steering column, up or down
- ▶ Turn the SmartKey in the starter switch to position **1** or **2** (▷ page 31).
- or
- ▶ Open the driver's door.

Getting started

Adjusting

Adjusting steering column in or out

- ▶ Move stalk forward or back in the direction of arrow ① until a comfortable steering wheel position is reached with your arms slightly bent at the elbow.

Adjusting steering column up or down

- ▶ Move stalk up or down in the direction of arrow ②.

Make sure your legs can move freely and that all the displays (incl. malfunction and indicator lamps) on the instrument cluster are clearly visible.



The memory function* (> page 99) lets you store the setting for the steering wheel together with the settings for the seat position and exterior rear view mirrors.

Mirrors

Adjust the interior and exterior rear view mirrors before driving so that you have a good view of the road and traffic conditions.

Warning!



In the case of an accident, liquid electrolyte may escape the mirror housing if the mirror glass breaks.

Electrolyte has an irritating effect. Do not allow the liquid to come into contact with eyes, skin, clothing, or respiratory system. In case it does, immediately flush affected area with water, and seek medical help if necessary.

Interior rear view mirror

- ▶ Manually adjust the interior rear view mirror.

For more information, see “Rear view mirrors” (> page 149).

Exterior rear view mirrors

Warning!



Exercise care when using the passenger side exterior rear view mirror. The mirror surface is convex (outwardly curved surface for a wider field of view). Objects in mirror are closer than they appear. Check your interior rear view mirror or glance over your shoulder before changing lanes.



Electrolyte drops coming into contact with the vehicle paint finish can only be completely removed while in their liquid state by applying plenty of water.

The buttons are located above the exterior lamp switch.

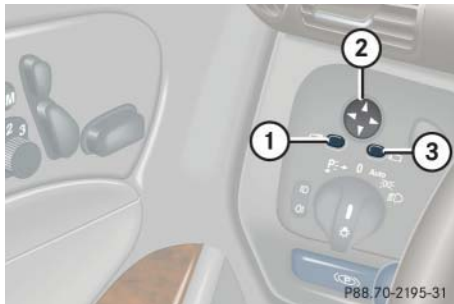

- ① Driver's side exterior rear view mirror button
- ② Adjustment button
- ③ Passenger-side exterior rear view mirror button

- ▶ Make sure the ignition is switched on.
All lamps in the instrument cluster come on.

- ▶ Press button ① for the left mirror or button ③ for the right mirror.
- ▶ Push adjustment button ② up, down, left, or right according to the desired setting.



If an exterior rear view mirror was forcibly pushed forward (hit from the rear) or forcibly pushed rearward (hit from the front), reposition it by applying firm pressure until it snaps into place. The mirror housing is now properly positioned and you can adjust the mirror normally.



The memory function* (▷ page 99) lets you store the setting for the exterior rear view mirrors together with the settings for the steering wheel and seat position.



At low ambient temperatures, the mirrors will be heated automatically.

For more information, see “Activating exterior rear view mirror parking position*” (▷ page 150).

Getting started

Driving

▼ Driving

Warning!



Do not lay any objects in the driver's footwell. Be careful that floor mats or carpets in the driver's footwell have sufficient clearance for the pedals.

During sudden driving or braking maneuvers the objects could get caught between the pedals. You could then no longer brake or accelerate.

Fastening the seat belt

Warning!



Always fasten your seat belt before driving off. Always make sure your passengers are properly restrained, even those sitting in the rear and pregnant women.

Failure to wear and properly fasten and position your seat belt greatly increases your risk of injuries and their likely severity in an accident. You and your passengers should always wear seat belts.

If you are ever in an accident, your injuries can be considerably more severe without your seat belt properly buckled. Without your seat belt buckled, you are much more likely to hit the interior of the vehicle or be ejected from it. You can be seriously injured or killed.

In the same crash, the possibility of injury or death is lessened if you are wearing your seat belt. The airbags can only protect as expected if the occupants are using their seat belts (> page 60).

Warning!



Children 12 years old and under must never ride in the front seat, except in a Mercedes-Benz authorized BabySmartTM¹ compatible child seat, which operates with the BabySmartTM system installed in the vehicle to deactivate the passenger front airbag when it is properly installed. Otherwise they will be struck by the airbag when it inflates in a crash. If this happens, serious or fatal injury will result.

According to accident statistics, children are safer when properly restrained in the rear seating positions than in the front seating positions. Infants and small children must ride in back seats and be seated in an appropriate infant or child restraint system, which is properly secured with the vehicle's seat belt and top tether strap, or secured via lower anchors and top tether strap, fully in accordance with the child seat manufacturer's instructions.

¹ BabySmartTM is a trademark of Siemens Automotive Corp.

A child's risk of serious or fatal injuries is significantly increased if the child restraints are not properly secured in the vehicle and the child is not properly secured in the child restraint.

Warning!



Never ride in a moving vehicle with the seat backrest reclined. Sitting in an excessively reclined position can be dangerous. You could slide under the seat belt in a collision. If you slide under it, the belt would apply force at the abdomen or neck. That could cause serious or even fatal injuries. The seat backrest and seat belt provide the best restraint when the wearer is in an upright position and the belt is properly positioned on the body.

Warning!



Never let more people ride in the vehicle than there are seat belts available. Be sure everyone riding in the vehicle is correctly restrained with a separate seat belt.

Warning!



Read and observe the additional warning notices printed in the "Safety and Security" section (▷ page 58) and (▷ page 60).

Getting started

Driving

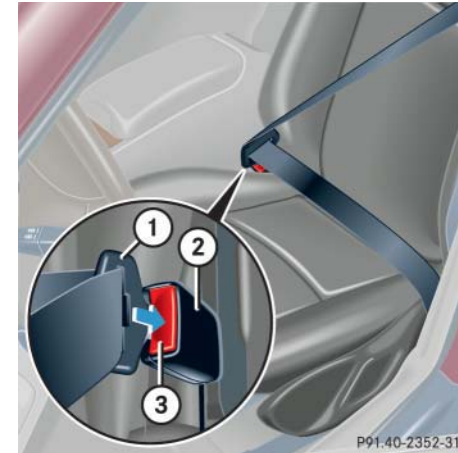

- ① Latch plate
- ② Buckle
- ③ Release button

- ▶ With a smooth motion, pull the belt from the belt outlet.
- ▶ Place the belt over your shoulder.
- ▶ Push latch plate ① into buckle ② until it clicks. ▷▷

Getting started

Driving

- ▷▷ If necessary, tighten the lap portion to a snug fit by pulling shoulder portion up.

Seat belt height adjustment

Adjust seat belt so that shoulder portion is located as close as possible to the middle of your shoulder (it should not touch the neck).

Front seats

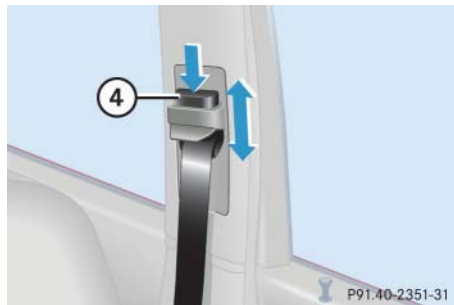

- ④ Button for belt outlet height adjustment
- ▶ Press button ④ and slide belt outlet upward or downward.

Proper use of seat belts

- Do not twist the belt when fastening.
- Adjust seat belt so that the shoulder portion is located as close as possible to the middle of the shoulder (it should not touch the neck or pass under the arm). For this purpose, you can adjust the height of the belt outlet.
- Position the lap belt as low as possible on your hips (over hip joint) and not across the abdomen.
- Place the seat backrest in a nearly upright position.
- Never use a seat belt for more than one person at a time.
- Do not fasten a seat belt around a person and another object at the same time.
- Check your seat belt during travel to ensure that it is properly positioned.

- Ensure that the seat belt is always fitted snugly. You should avoid wearing bulky clothing, such as winter coats, when traveling in the vehicle.

Warning!



Do not pass belts over sharp edges. They could tear.

Do not allow the belt to get caught in the door or in the seat adjustment mechanism. This could damage the belt.

Never attempt to make modifications to seat belts. This could impair the effectiveness of the belts.

Damaged seat belts or belts that were highly stressed in an accident must be replaced. Contact an authorized Mercedes-Benz Center.

Starting the engine

Warning!



Inhalation of exhaust gas is hazardous to your health. All exhaust gas contains carbon monoxide, and inhaling it can cause unconsciousness and lead to death.

Do not run the engine in confined areas (such as garage) which are not properly ventilated. If you think that exhaust gas fumes are entering the vehicle while driving, have the cause determined and corrected immediately. If you must drive under these conditions, drive only with at least one window fully open.

Manual transmission

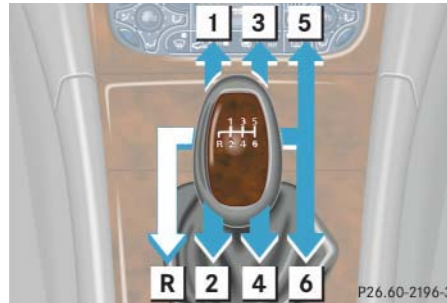

Gearshift pattern for manual transmission

For more information, see “Manual transmission” (▷ page 141).

Starting

- ▶ Depress brake pedal.
- ▶ Make sure the gearshift lever is in neutral position (no gear selected).
- ▶ Fully depress clutch pedal.
Otherwise the engine cannot be started due to the integrated safety interlock.
- ▶ Do not depress the accelerator.
- ▶ Turn the SmartKey in the starter switch to position **3** and hold until the engine starts (▷ page 31).

For information on turning off the engine, see “Turning off engine” (▷ page 52).

Getting started

Driving

Automatic transmission*

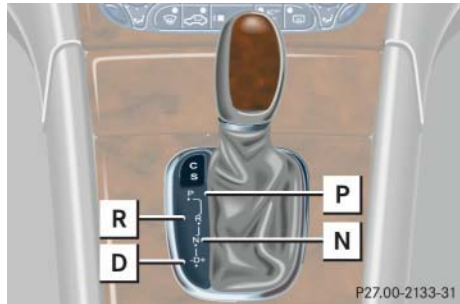

Gearshift pattern for automatic transmission

- P** Park position with gear selector lever lock
- R** Reverse gear
- N** Neutral
- D** Drive position

For more information, see “Automatic transmission*” (▷ page 142).

Starting

- ▶ Make sure the gear selector lever is set to **P**.
- ▶ Do not depress the accelerator.
- ▶ Turn the SmartKey in the starter switch to position **3** and hold until the engine starts (▷ page 31).



You can also use the “touch-start” function. Turn the SmartKey to position **3** and release it again immediately. The engine then starts automatically.

- ▶ Depress the brake pedal.

The gear selector lever lock is released.

For information on turning off the engine, see “Turning off engine” (▷ page 52).

Starting difficulties

If the engine does not start as described, carry out the following steps:

- ▶ Turn SmartKey in starter to position **0** and repeat starting procedure (▷ page 43).
- ▶ Remember that extended starting attempts can drain the battery.
- ▶ Get a jump start (▷ page 326).

If the engine does not start after several starting attempts, there could be a malfunction in the engine electronics or in the fuel supply system.

- ▶ Notify an authorized Mercedes-Benz Center.

Parking brake

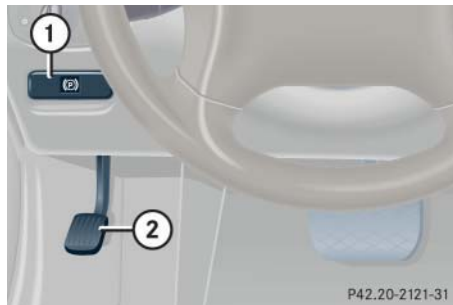

- ① Release handle
- ② Parking brake

Warning!

When leaving the vehicle, always remove the SmartKey from the starter switch and lock the vehicle. Do not leave children unattended in the vehicle, or with access to an unlocked vehicle. Children could release the parking brake, which could result in an accident and/or serious injury.

- ▶ Release parking brake by pulling on handle ①.

The warning lamp **BRAKE** (USA only) or **(P)** (Canada only) in the instrument cluster goes out.

Driving

- ▶ Depress the brake pedal.
- ▶ Move gear selector lever to position **D** or **R** (manual transmission: first or reverse gear).



Vehicles with automatic transmission: Wait for the gear selection process to complete before setting the vehicle in motion.

- ▶ Release the brake pedal.
- ▶ Carefully depress the accelerator.

Once the vehicle is in motion, the automatic central locking system engages and the locking knobs drop down.



You can open a locked door from the inside. Open door only when conditions are safe to do so.

You can deactivate the automatic locking using the control system (▷ page 133).



Simultaneously depressing the accelerator pedal and applying the brake reduces engine performance and causes premature brake and drivetrain wear.



If you hear a warning signal when driving off, you have forgotten to release the parking brake.

Release the parking brake.

Getting started

Driving

After a cold start, the automatic transmission shifts at a higher engine revolution. This allows the catalytic converter to reach its operating temperature earlier.

Warning!



On slippery road surfaces, never downshift in order to obtain braking action. This could result in drive wheel slip and reduced vehicle control. Your vehicle's ABS will not prevent this type of loss of control.



Place the gear selector lever in position **R** only when the vehicle is stopped in order to avoid damaging the transmission.



Do not run cold engine at high engine speeds. Running a cold engine at high engine speeds may shorten the service life of the engine.

Warning!



Vehicles with automatic transmission:
It is dangerous to shift the gear selector lever out of **P** or **N** if the engine speed is higher than idle speed. If your foot is not firmly on the brake pedal, the vehicle could accelerate quickly forward or in reverse. You could lose control of the vehicle and hit someone or something. Only shift into gear when the engine is idling normally and when your right foot is firmly on the brake pedal.

For more information on driving, see “Driving instructions” (▷ page 239).

Switching on headlamps

The exterior lamp switch is located on the dashboard to the left of the steering wheel.



Exterior lamp switch

- ① Off
 - ② Low beam headlamps on
- ▶ Turn switch to .

For more information on headlamps, see “Lighting” (▷ page 102).

Turn signals and high beam

The combination switch is on the left of the steering column.

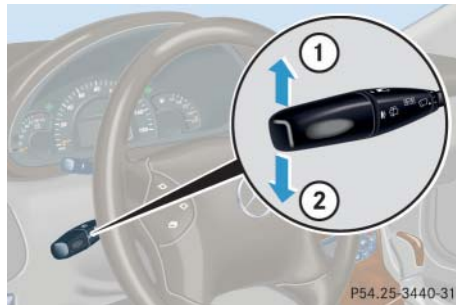

Combination switch

- ① Turn signals, right
- ② Turn signals, left

- ▶ Press combination switch up ① or down ②.



To signal minor directional changes, move combination switch to point of resistance only and release. The turn signal flashes three times.

High beam

- ▶ Push combination switch forward.

The high beam symbol  in the instrument cluster comes on.

For more information on high beam, see “Combination switch” (▶ page 105).

Windshield wipers

The combination switch is located on the left of the steering column.

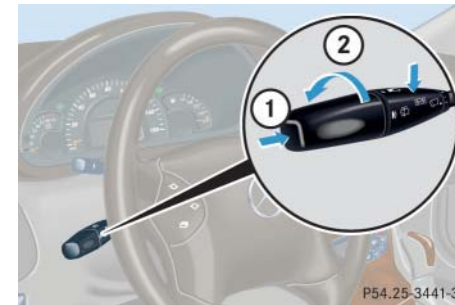

Combination switch

- ① Single wipe
- ② Switching on windshield wipers

- ▶ Make sure the ignition is switched on.

Getting started

Driving

Switching on windshield wipers

- ▶ Turn the combination switch to the desired position depending on the intensity of the rain.

- 0 Windshield wipers off
- I Intermittent wiping
- II Normal wiper speed
- III Fast wiper speed



Vehicles without rain sensor*:
Fast wiper speed **III** goes to setting **II** when the vehicle is standing still.

Vehicles with rain sensor*:
Intermittent wiping interval is dependent on wetness of windshield. Wiping will not occur with a front door open.



Vehicles with rain sensor*:
Do not leave windshield wipers in intermittent setting when the vehicle is taken to an automatic car wash or during windshield cleaning. Wipers will operate in the presence of water sprayed on the windshield, and wipers may be damaged as a result.

The switch should not be left in intermittent setting as the wipers will wipe the windshield once every time the engine is started. Dust that accumulates on the windshield might scratch the glass and/or damage the wiper blades when wiping occurs on a dry windshield.

Single wipe

- ▶ Press combination switch briefly in direction of arrow ①.

The windshield wipers wipe one time without washer fluid.

Wiping with windshield washer fluid

- ▶ Push combination switch in direction of arrow ① past the resistance point.

The windshield wipers operate with washer fluid.

For information on filling up the washer reservoir, see “Windshield washer system and headlamp cleaning system*” (▷ page 259).



If anything blocks the windshield wipers (leaves, snow, etc.), switch them off immediately.

- For safety reasons, withdraw SmartKey from starter switch before attempting to remove any blockage.
- Remove blockage.
- Turn the windshield wipers on again.

If windshield wipers fail to function at all in switch position I,

- set the combination switch to the next highest wiper speed
- have the windshield wipers checked at the nearest authorized Mercedes-Benz Center

Problems while driving

The engine runs erratically and misfires

- An ignition cable may be damaged.
- The engine electronics may not be operating properly.
- Unburned gasoline may have entered the catalytic converter and damaged it.
 - ▶ Give very little gas.
 - ▶ Have the problem repaired by an authorized Mercedes-Benz Center as soon as possible.

The coolant temperature is over 248°F (120°C)

The coolant is too hot and is no longer cooling the engine.

- ▶ Stop the vehicle as soon as possible and turn off the engine. Allow engine and coolant to cool.
- ▶ Check the coolant level and add coolant if necessary (▷ page 257).

In case of accident

If the vehicle is leaking gasoline:

- ▶ Do not start the engine under any circumstances.
- ▶ Notify local fire and/or police authorities.

If the extent of the damage cannot be determined:

- ▶ Notify an authorized Mercedes-Benz Center.

If no damage can be determined on the

- major assemblies
- fuel system
- engine mount:
 - ▶ Start the engine in the usual manner.

Getting started

Parking and locking

▼ Parking and locking

You have now completed your first drive. You have properly stopped and parked your vehicle. End your drive as follows.

Warning!



Wait until the vehicle is stationary before removing the SmartKey from the starter switch. The vehicle cannot be steered when the SmartKey is removed.

Warning!



With the engine not running, there is no power assistance for the brake and steering system. In this case, it is important to keep in mind that a considerably higher degree of effort is necessary to brake and steer the vehicle.

Warning!



Do not park this vehicle in areas where combustible materials such as grass, hay or leaves can come into contact with the hot exhaust system, as these materials could be ignited and cause a vehicle fire.

To reduce the risk of personal injury as a result of vehicle movement, before turning off the engine and leaving the vehicle always:

- Keep right foot on brake pedal.
- Firmly depress parking brake pedal.
- Move the gear selector lever to position **P** (manual transmission: first or reverse gear).
- Slowly release brake pedal.
- When parked on an incline, turn front wheels towards the road curb.
- Turn the SmartKey to starter switch position **0** and remove.
- Take the SmartKey and lock vehicle when leaving.

Parking brake

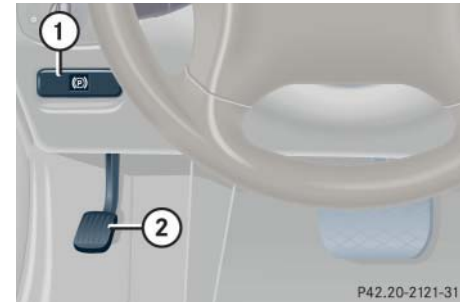

- ① Release handle
- ② Parking brake

- Step firmly on parking brake ②.

When the engine is running, the warning lamp **BRAKE** (USA only) or  (Canada only) in the instrument cluster will be illuminated.

Warning!



When leaving the vehicle, always remove the SmartKey from the starter switch and lock the vehicle. Do not leave children unattended in the vehicle, or with access to an unlocked vehicle. Children could release the parking brake and/or move the gear selector lever from position **P**, either of which could result in an accident and/or serious injury.

Warning!



Getting out of your vehicle with the gear selector lever not fully engaged in position **P** is dangerous. Also, when parked on an incline, position **P** alone may not prevent your vehicle from moving, possibly hitting people or objects.

Always set the parking brake in addition to shifting to position **P** (manual transmission: first or reverse gear).

When parked on an incline, turn front wheel towards the road curb.

Switching off headlamps

- ▶ Turn the exterior lamp switch to **0** (▷ page 46).

For more information on headlamps, see “Lighting” (▷ page 102).

Getting started

Parking and locking

Turning off engine

- ▶ Place the gear selector lever in position **P** (manual transmission: first or reverse gear).



Always set the parking brake in addition to shifting to position **P** (manual transmission: first or reverse gear).

On steep slopes, turn the front wheels towards the road curb.

- ▶ Turn the SmartKey in the starter switch to position **0** and remove it. The immobilizer is activated.



Vehicles with automatic transmission: The SmartKey can only be removed from the starter switch with the gear selector lever in position **P**.

- ▶ Press the seat belt release button (▷ page 41).

Allow the retractor to completely rewind the seat belt by guiding the latch plate.



With the SmartKey removed and the driver's door open, a warning sounds if the vehicle's exterior lamps are not switched off.

Warning!



To prevent possible personal injury, always keep hands and fingers away from the door openings when closing the doors. Be especially careful when small children are around.

Before closing doors, make sure there is no possibility of someone getting caught in a door during closing.

- ▶ After exiting the vehicle, press the lock button  on the SmartKey (▷ page 30).

All turn signal lamps flash three times. The locking knobs in the doors move down.

Warning!



When leaving the vehicle, always remove the SmartKey from the starter switch, and lock your vehicle. Do not leave children unattended in the vehicle, or with access to an unlocked vehicle. Unsupervised use of vehicle equipment may cause an accident and/or serious personal injury.

For more information, see “Locking and unlocking” (▷ page 82).



Safety and Security

Occupant safety

Panic alarm*

Driving safety systems

Anti-theft systems

Safety and Security

Occupant safety

▼ Occupant safety

In this section you will learn the most important facts about the restraint systems of the vehicle.

The restraint systems are

- Seat belts
- Emergency tensioning device
- Airbags
- Child seats
- Child seat recognition
- Lower anchors and tethers for children (LATCH)

As independent systems, their protective effects work in conjunction with each other.



For information on infants and children traveling with you in the vehicle and restraint systems for infants and children, see “Children in the vehicle” (▷ page 63).

The **SRS** indicator lamp in the instrument cluster (▷ page 22) comes on:

- for about four seconds when you turn the SmartKey in the starter switch to position **1**.
- for about four seconds when you start the engine by turning the SmartKey.



The **SRS** indicator lamp remains lit if the SmartKey is turned to position **2** and left there. The indicator lamp will go out when you start the engine.

The **SRS** indicator lamp goes out shortly after you start the engine. This shows that the restraint systems are operational.

A malfunction in the system has been detected if the **SRS** indicator lamp:

- fails to extinguish after approximately four seconds.
- does not come on at all.
- comes on after the engine was started or while driving.

For safety reasons, we strongly recommend that you visit an authorized Mercedes-Benz Center immediately to have the system checked.

For more information, see “Practical hints” (▷ page 278).

Warning!



In the event that the SRS malfunction indicator lamp comes on during driving or does not come on at all, the SRS may not be operational. For your safety, we strongly recommend that you visit an authorized Mercedes-Benz Center immediately to have the system checked; otherwise the SRS may not be activated when needed in an accident, which could result in serious or fatal injury, or it might deploy unexpectedly and unnecessarily which could also result in injury.

Improper work on the restraint systems, including incorrect installation and removal, can lead to possible injury through an unintended activation of the SRS.

In addition, through improper work there is a risk of rendering the SRS inoperative or causing unintended airbag deployment. Work on the SRS must therefore only be performed by qualified technicians. Contact your authorized Mercedes-Benz Center.

Airbags

Warning!



Airbags are designed to reduce the potential of injury and fatality in certain frontal impacts (front airbags), or side impacts (side impact airbags and head protection window curtain airbags). However, no system available today can totally eliminate injuries and fatalities.

The activation of the SRS temporarily releases a small amount of dust from the airbags. This dust, however, is neither injurious to your health, nor does it indicate a fire in the vehicle. The dust might cause some temporary breathing difficulty for people with asthma or other breathing trouble. To avoid this, you may wish to get out of the vehicle as soon as it is safe to do so. If you have any breathing difficulty but cannot get out of the vehicle after the airbag inflates, then get fresh air by opening a window or door.

Warning!



To reduce the risk of injury when the front airbags inflate, it is very important for the driver and front passenger to always be in a properly seated position and to wear your seat belts.

For maximum protection in the event of a collision always be in normal seated position with your back against the backrest. Fasten your seat belt and ensure that it is properly positioned on your body.

Since the airbag inflates with considerable speed and force, a proper seating and hands on steering wheel position will help to keep you at a safe distance from the airbag. Occupants who are unbelted, out of position or too close to the airbag can be seriously injured by an airbag as it inflates with great force in the blink of an eye:

- Sit properly belted in an upright position with your back against the seat backrest.



Safety and Security

Occupant safety



- Adjust the driver seat as far as possible rearward, still permitting proper operation of vehicle controls. The distance from the center of the driver's breastbone to the center of the airbag cover on the steering wheel must be at least ten inches (25 cm) or more. You should be able to accomplish this by a combination of adjustments to the seat and steering wheel. If you have any problems, please see your authorized Mercedes-Benz Center.
- Do not lean with your head or chest close to the steering wheel or dashboard.
- Keep hands on the outside of steering wheel rim. Placing hands and arms inside the rim can increase the risk and potential severity of hand/arm injury when driver front airbag inflates.

- Adjust the front passenger seat as far as possible rearward from the dashboard when the seat is occupied.
- Occupants, especially children, should never lean their heads in the area of the door where the side airbag inflates. This could result in serious injuries or death should the airbag be triggered. Always sit upright, properly use the seat belts and appropriate size infant or child restraint system.
- Children 12 years old and under must never ride in the front seat, except in a Mercedes-Benz authorized BabySmart^{TM1} compatible child seat, which operates with the BabySmartTM system installed in the vehicle to deactivate the passenger front airbag when it is properly installed. Otherwise they will be struck by the airbag when it inflates in a crash. If this happens, serious or fatal injury will result.

¹ BabySmartTM is a trademark of Siemens Automotive Corp.

Failure to follow these instructions can result in severe injuries to you or other occupants.

If you sell your vehicle you are responsible to make the buyer aware of these points. Make sure to give the buyer this Operator's Manual.

Safety and Security

Occupant safety

Warning!



Accident research shows that the safest place for children in an automobile is in the rear seat. Should you choose to place a child 12 years old or under in the front passenger seat of your vehicle, you must properly use a BabySmartTM¹ child restraint which will turn off the passenger front airbag. BabySmartTM will not, however, turn off any side impact airbag.

It should be noted that with respect to both front and rear side impact airbags there is a possibility for a side airbag related injury if occupants, especially children, are not properly seated or restrained when next to a side airbag which needs to deploy rapidly in a side impact in order to do its job.

¹ BabySmartTM is a trademark of Siemens Automotive Corp.

To help avoid the possibility of injury, please follow these guidelines:

- (1) Occupants, especially children, should never place their bodies or lean their heads in the area of the door where the side airbag inflates. This could result in serious injuries or death should the side airbag be activated.
- (2) Always sit upright, properly use the seat belts and use an appropriately sized infant or child restraint system for all children 12 years old or under.
- (3) Always wear seat belts properly.

If you believe that, even with the use of these guidelines, it would be safer for your rear seat occupants to have both rear door mounted side airbags deactivated, then deactivation can be accomplished upon your written request to do so at your authorized Mercedes-Benz Center at an additional cost.

Please contact your local authorized Mercedes-Benz Center or call our Customer Assistance Center at 1-800-FOR-MERCEdes (1-800-367-6372) for details.



Airbags are designed to activate only in certain frontal impacts (front airbags) and in side impacts (side impact and head protection window curtain airbags) which exceed preset thresholds.

Only during these types of impacts, if of sufficient severity to meet the deployment thresholds, will they provide their supplemental protection.

The driver and passengers should always wear their seat belts. Otherwise it is not possible for airbags to provide their supplemental protection.

Safety and Security

Occupant safety

In cases of other frontal impacts, angled impacts, roll-overs, other side impacts, rear collisions, or other accidents, the airbags will not be activated. The driver and passengers will then be protected by the fastened seat belts.

We caution you not to rely on the presence of the airbags in order to avoid wearing your seat belt.

Your vehicle was originally equipped with airbags that are designed to activate in certain impacts exceeding a preset threshold to reduce the potential and severity of injury. It is important to your safety and that of your passengers that you replace deployed airbags and repair any malfunctioning airbags to ensure that the vehicle will continue to provide supplemental crash protection for occupants.

Safety guidelines for the seat belt, emergency tensioning device and airbag

Warning!



- Damaged seat belts or belts that were highly stressed in an accident must be replaced and their anchoring points must also be checked. Only use belts installed or supplied by an authorized Mercedes-Benz Center.
- Airbags and emergency tensioning devices (ETDs) are designed to function on a one-time only basis. An airbag or ETD that was activated must be replaced

- No modifications of any kind may be made to any components or wiring of the SRS. This includes changing or removing any component or part of the SRS, the installation of additional trim material, badges, etc. over the steering wheel hub, passenger front airbag cover, door trim panels, or door frame trims, and installation of additional electrical/electronic equipment on or near SRS components and wiring. Keep area between airbags and occupants free from objects (e.g. packages, purses, umbrellas, etc.).
- Do not pass belts over sharp edges. They could tear.
- Do not make any modification that could change the effectiveness of the belts.
- Do not hang items such as coat hangers from the coat hooks or handles over the door. These items may turn into projectiles and cause head and other injuries when curtain airbag is deployed.

- An airbag system component within the steering wheel gets hot after the airbag has inflated. Do not touch.
- Improper work on the system, including incorrect installation and removal, can lead to possible injury through an unintended activation of the SRS.
- In addition, through improper work there is a risk of rendering the SRS inoperative or causing unintended airbag deployment. Work on the SRS must therefore only be performed by qualified technicians. Contact your authorized Mercedes-Benz Center.
- For your protection and the protection of others, when scrapping the airbag unit or emergency tensioning device, our safety instructions must be followed. These instructions are available from your authorized Mercedes-Benz Center.
- Given the considerable deployment speed and the textile structure of the airbags, there is the possibility of abrasions or other injuries resulting from airbag deployment.

When you sell your vehicle we strongly urge you to give notice to the subsequent owner that it is equipped with an SRS by alerting them to the applicable section in the Operator's Manual.

Front airbags



- ① Driver's airbag
- ② Passenger front airbag

Driver and passenger airbags are deployed:

- in the event of a frontal impact
- if impact exceeds a preset deployment threshold
- independently of the side impact airbags

The airbags will not deploy in impacts which do not exceed the system's deployment thresholds. You will then be protected by the fastened seat belts.

The passenger front airbag will only be deployed if:

- the front passenger seat is occupied
- the PASS. AIRBAG OFF indicator lamp in the center console is not lit (▷ page 66)
- the impact exceeds a preset deployment threshold

Safety and Security

Occupant safety



Do not place objects heavier than 20 lbs (9 kg) on the front passenger seat. This could cause the front or side impact airbag on the front passenger side to deploy in a crash which exceeds the system's deployment threshold.

Side impact airbags, window curtain airbags

The window curtain airbags ① fill up the area between the A and C pillars (see arrows).

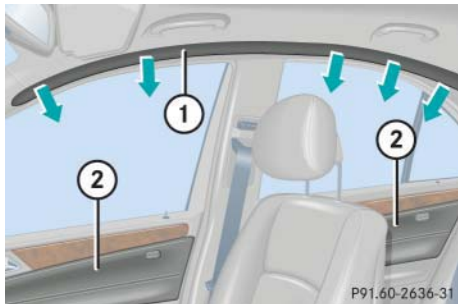

- ① Window curtain airbag
- ② Side impact airbags

The side impact airbags and window curtain airbags are deployed:

- on the impacted side of the vehicle
- in impacts exceeding a preset deployment threshold
- independently of the front airbags

The front passenger side impact airbag will only deploy if the system senses that the front passenger seat is occupied.

The side impact airbags and window curtain airbags are not deployed in impacts which do not exceed the system's deployment threshold.

Seat belts

When the engine is started, the seat belt non-usage warning lamp  illuminates to remind you and your passengers to fasten your seat belts. If the driver's seat belt is not fastened before the engine is started, the seat belt non-usage warning

lamp  illuminates and a warning chime sounds for approximately six seconds when the engine is started.

The use of seat belts and infant and child restraint systems is required by law in all 50 states, the District of Columbia, the U.S. territories and all Canadian provinces.

Even where this is not the case, all vehicle occupants should have their seat belts fastened whenever the vehicle is in motion.

For more information on seat belts, see "Fastening the seat belt" (> page 40).



For information on infants and children traveling with you in the vehicle and restraint systems for infants and children, see "Children in the vehicle" (> page 63).

Safety and Security

Occupant safety

Warning!



Always fasten your seat belt before driving off. Always make sure your passengers are properly restrained, even those sitting in the rear and pregnant women.

Failure to wear and properly fasten and position your seat belt greatly increases your risk of injuries and their likely severity in an accident. You and your passengers should always wear seat belts.

If you are ever in an accident, your injuries can be considerably more severe without your seat belt properly buckled. Without your seat belt buckled, you are much more likely to hit the interior of the vehicle or be ejected from it. You can be seriously injured or killed.

In the same crash, the possibility of injury or death is lessened if you are properly wearing your seat belt. Airbags can only protect as they are designed if the occupants are properly wearing their seat belts.

Warning!



Never ride in a moving vehicle with the seat backrest reclined. Sitting in an excessively reclined position can be dangerous. You could slide under the seat belt in a collision. If you slide under it, the belt would apply force at the abdomen or neck. That could cause serious or even fatal injuries. The seat backrest and seat belt provide the best restraint when the wearer is in an upright position and the belt is properly positioned on the body.

Warning!



Never let more people ride in the vehicle than there are seat belts available. Be sure everyone riding in the vehicle is correctly restrained with a separate seat belt.

Warning!



Damaged seat belts or belts that were highly stressed in an accident must be replaced and their anchoring points must also be checked.

Only use seat belts which have been approved by Mercedes-Benz.

Do not make any modifications to the seat belts. This can lead to unintended activation or to failure.

Have all work carried out only by qualified technicians. Contact your authorized Mercedes-Benz Center.

Safety and Security

Occupant safety

Warning!



USE SEAT BELTS PROPERLY

- Seat belts can only work when used properly. Never wear seat belts in any other way than as described in this section, as that could result in serious injuries in case of an accident.
 - Each occupant should wear their seat belt at all times, because seat belts help reduce the likelihood of and potential severity of injuries in accidents, including rollovers. The integrated restraint system includes SRS (driver airbag, passenger front airbag, side impact airbags, head protection window curtain airbags for side windows), ETD (seat belt emergency tensioning device), and front seat knee bolsters. The system is designed to enhance the protection offered to properly belted occupants in certain frontal (front airbags) and side (side impact airbags and window curtain airbags) impacts which exceed preset deployment thresholds.
- Never wear the shoulder belt under your arm, against your neck or off your shoulder. In a crash, your body would move too far forward. That would increase the chance of head and neck injuries. The belt would also apply too much force to the ribs or abdomen, which could severely injure internal organs such as your liver or spleen.
 - Never wear belts over rigid or breakable objects in or on your clothing, such as eyeglasses, pens, keys, etc., as these might cause injuries.
 - Position the lap belt as low as possible on your hips and not across the abdomen. If the belt is positioned across your abdomen, it could cause serious injuries in a crash.
- Never use a seat belt for more than one person at a time. Do not fasten a seat belt around a person and another person or other objects.
 - Belts should not be worn twisted. In a crash, you wouldn't have the full width of the belt to manage impact forces. The twisted belt against your body could cause injuries.
 - Pregnant women should also use a lap-shoulder belt. The lap belt portion should be positioned as low as possible on the hips to avoid any possible pressure on the abdomen.
 - Never place your feet on the instrument panel or on the seat. Always keep both feet on the floor in front of the seat.

Emergency tensioning device (ETD), seat belt force limiter

The seat belts for the front and rear outer seats are equipped with emergency tensioning devices and belt force limiters.

The ETD is designed to activate in the following cases when the seat belts are fastened:

- in frontal or rear-end impacts exceeding a preset severity level.
- if the restraint systems are operational and functioning correctly.
See **SRS** indicator lamp (▷ page 54).

In an impact, emergency tensioning devices remove slack from the belts in such a way that the seat belts fit more snugly against the body. Belt force limiters reduce the force exerted by the seat belts on occupants during a crash.

Warning!



An emergency tensioning device (ETD) that was activated must be replaced.

When scrapping the emergency tensioning device, our safety instructions must be followed. These are available at your authorized Mercedes-Benz Center.



Do not place objects heavier than 20 lbs (9 kg) on the front passenger seat. This could cause the front or side impact airbag on the front passenger side to deploy in a crash which exceeds the system's deployment threshold.

Children in the vehicle

If an infant or child is traveling with you in the vehicle:

- Secure the child using an infant or child restraint appropriate to the age and size of the child and recommended for use by Mercedes-Benz.
- Ensure that the infant or child is properly secured by a belt at all times while the vehicle is in motion.

Infant and child restraint seats and information on choosing an appropriate restraint system can be obtained from any Mercedes-Benz Center.

Infant and child restraint systems

Only use a BabySmart^{TM1} compatible child restraint for the front passenger seat in this vehicle.

¹ BabySmartTM is a trademark of Siemens Automotive Corp.

Safety and Security

Occupant safety

We recommend all infants and children be properly restrained at all times while the vehicle is in motion.

All lap-shoulder belts except the driver's seat belt have special seat belt retractors for secure fastening of child restraints.

To fasten a child restraint, follow child restraint instructions for mounting. Then pull the shoulder belt out completely and let it retract. During the seat belt retraction, a ratcheting sound can be heard to indicate that the special seat belt retractor is activated. The belt is now locked. Push down on child restraint to take up any slack.

To deactivate, release seat belt buckle and let seat belt retract completely. The seat belt can again be used in the usual manner.



For information on child seats with anchor fittings for tether anchorages, see "Installation of infant and child restraint systems" (> page 68).

For information on child seat anchors - LATCH-type (> page 69).

Warning!



Never release the seat belt buckle while the vehicle is in motion, since the special seat belt retractor will be deactivated.



The use of infant or child restraints is required by law in all 50 states, the District of Columbia, the U.S. territories, and all Canadian provinces.

Infants and small children should be seated in an appropriate infant or child restraint system properly secured by a lap-shoulder belt or, if so equipped, a child restraint lower anchorage system that complies with U.S. Federal Motor Vehicle Safety Standards 213 and 225 and Canadian Motor Vehicle Safety Standards 213 and 210.2.

A statement by the child restraint manufacturer of compliance with this standard can be found on the instruction label on the restraint and in the instruction manual provided with the restraint.

When using any infant or child restraint system, be sure to carefully read and follow all manufacturer's instructions for installation and use.

Please read and observe warning labels affixed to inside of vehicle and to infant or child restraints.

Warning!



Children 12 years old and under must never ride in the front seat, except in a Mercedes-Benz authorized BabySmart^{TM1} compatible child seat, which operates with the BabySmartTM system installed in the vehicle to deactivate the passenger front airbag when it is properly installed. Otherwise they will be struck by the airbag when it inflates in a crash. If this happens, serious or fatal injury will result.

According to accident statistics, children are safer when properly restrained in the rear seating positions than in the front seating positions. Infants and small children must ride in back seats and be seated in an appropriate infant or child restraint system, which is properly secured with the vehicle's seat belt and top tether strap, or secured via lower anchors and top tether strap, fully in accordance with the child seat manufacturer's instructions.

¹ BabySmartTM is a trademark of Siemens Automotive Corp.

Safety and Security

Occupant safety

Infants and small children should never share a seat belt with another occupant. During an accident, they could be crushed between the occupant and seat belt.

A child's risk of serious or fatal injuries is significantly increased if the child restraints are not properly secured in the vehicle and the child is not properly secured in the child restraint.

Children too big for child restraint systems must ride in back seats using regular seat belts. Position shoulder belt across chest and shoulder, not face or neck. A booster seat may be necessary to achieve proper belt positioning for children from 41 lbs until they reach a height where a lap/shoulder belt fits properly without a booster. >>

Safety and Security

Occupant safety

▷▷ When the child restraint is not in use, remove it from the vehicle or secure it with the seat belt to prevent the child restraint from becoming a projectile in the event of an accident.

Do not leave children unattended in the vehicle; even if the children are secured in a child restraint system. Unsupervised children in a child restraint system may use vehicle equipment and may cause an accident and/or serious personal injury.

BabySmart™¹ airbag deactivation system



Special BabySmart™ compatible child seats, designed for use with the Mercedes-Benz system and available at any authorized Mercedes-Benz Center are required for use with the BabySmart™ airbag deactivation system. With the special child seat properly installed, the passenger front airbag will not deploy.

¹ BabySmart™ is a trademark of Siemens Automotive Corp.

The PASS. AIRBAG OFF indicator lamp located in the center console will be illuminated, except with the SmartKey removed or in starter switch position **0**.



The system does not deactivate the side impact airbag and the emergency tensioning device.

Self-test BabySmart™ without special child seat installed

After turning the SmartKey in the starter switch to position **1** or **2**, the PASS. AIRBAG OFF indicator lamp located in the center console comes on for approximately six seconds and then goes out.

If the indicator lamp should not come on or is continuously lit, the system is not functioning. You must see an authorized Mercedes-Benz Center before seating any child on the passenger seat.

For more information, see “Practical hints” (▷ page 279).

Safety and Security

Occupant safety

Warning!



The BabySmart^{TM1} airbag deactivation system will ONLY work with a special child seat designed to operate with it. It will not work with child seats which are not BabySmartTM compatible.

Never place anything between seat cushion and child seat (e.g. pillow), since it reduces the effectiveness of the deactivation system. The bottom of the child seat must make full contact with the passenger seat cushion. An incorrectly mounted child seat could cause injuries to the child in case of an accident, instead of protecting the child.

Follow the manufacturer's instructions for installation of special child seats.

¹ BabySmartTM is a trademark of Siemens Automotive Corp.

Warning!



When using a BabySmartTM compatible child seat on the front passenger seat, the passenger front airbag will not deploy only if the PASS. AIRBAG OFF indicator lamp remains illuminated.

Please be sure to check the indicator every time you use the special system child seat. Should the light go out while the restraint is installed, please check installation. If the light remains out, do not use the BabySmartTM restraint to transport children on the front passenger seat until the system has been repaired.

Warning!



Do not place powered-on laptops, cell phones and like electronic devices on the front passenger seat. Signals from such devices may interfere with the BabySmartTM system. Such signal interference may cause the PASS. AIRBAG OFF indicator lamp not to come on during self-test or be continuously lit, indicating that the system is not functioning.

Safety and Security

Occupant safety

Installation of infant and child restraint systems

This vehicle is equipped with tether anchorages for a top tether strap at each of the rear seating positions.

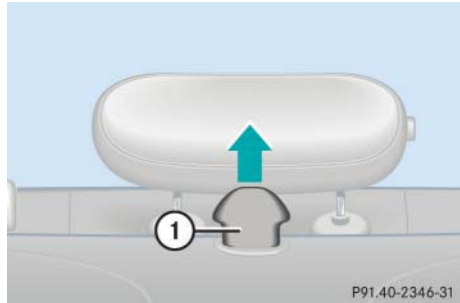

① Cover of top anchorage ring

- ▶ Make sure the rear backrest is locked in its upright position (▷ page 213).

Warning!



Always lock backrest in its upright position when rear seat bench is occupied by passengers, or the extended cargo area is not in use. Check for secure locking by pushing and pulling on the backrest.

- ▶ Remove cover ① from anchorage ring ③.

- ▶ Guide tether strap between head restraint and top of seat back.

Head restraint must be installed (if removable) and positioned such that the top tether strap can pass freely between the head restraint and top of seat back.

Make sure the tether strap is not twisted.

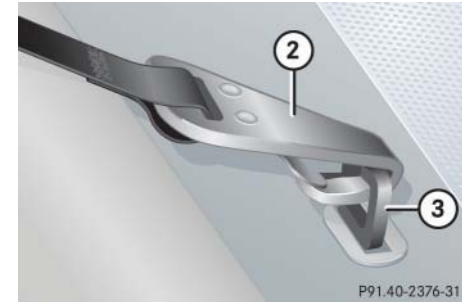

② Hook

③ Anchorage ring

- ▶ Securely fasten hook ②, which is part of the tether strap, to anchorage ring ③.

①

For safety, make sure the hook has attached to the ring beyond the safety catch, as illustrated.

- ▶ Reinstall cover ① after removing the tether strap.

Safety and Security

Occupant safety

Child seat anchors – LATCH-type

This vehicle is equipped with two LATCH- (Lower Anchors and Tethers for Children) type anchors (at each of the outer rear seats) for the installation of a LATCH-type child seat with the matching mounting fittings.

If a child seat is not installed, the LATCH-type anchors can be folded back between the seat cushion and the backrest.

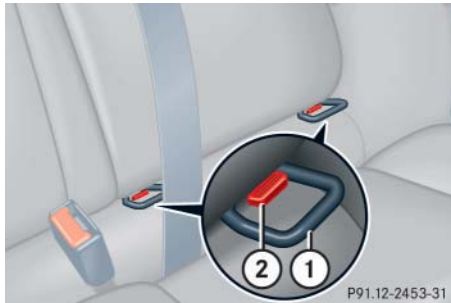

- ① Anchors
- ② Button

- ▶ Grip inner side of anchors ① and fold forward until they audibly lock in place.

- ▶ Install child seat according to the manufacturer's instructions.



The child seat must be firmly attached in the right and left side anchors ①.

With a child seat installed in the left rear seat, the seat belt for the center seat occupied by a passenger must operate freely. Guide seat belt between its seat cushion mount and backrest mount along outside of right side child seat anchor.

To fold anchors back

- ▶ Press down button ② on each anchor and return anchor ① to its catch.



Non-LATCH-type child seats may also be used and can be installed using the vehicle's seat belt system. Install child seat according to the manufacturer's instructions.

Warning!



Children too big for child restraint systems must ride in back seats using regular seat belts. Position shoulder belt across chest and shoulder, not face or neck. A booster seat may be necessary to achieve proper belt positioning for children from 41 lbs until they reach a height where a lap/shoulder belt fits properly without a booster.

Before installing the child seat, make sure anchors ① are folded out and locked in place.

Install child seat according to manufacturer's instructions.



Safety and Security

Occupant safety

- ▷▷ The child seat must be firmly attached in the right and left side anchors ①.
- An incorrectly mounted child seat may come loose during an accident which could result in serious injury or death to your child.
- Damaged or impact-damaged child seats or child seat anchors ① must be replaced.
- Do not leave children unattended in the vehicle, even if the children are secured in a child restraint system.

Blocking of rear door window operation

The override switch is located on the door control panel of the driver's door.



① Override switch

- ▶ Slide override switch ① to the right.
The rear door windows can no longer be operated using the switch located in the rear doors.



Operation of the rear door windows with the switches located on the door control panel of the driver's door is still possible.

Warning!



Activate the override switch when children are riding in the back seats of the vehicle. The children may otherwise injure themselves, e.g. by becoming trapped in the window opening.

When leaving the vehicle, always remove the SmartKey from the starter switch, and lock the vehicle. Do not leave children unattended in the vehicle, or with access to an unlocked vehicle. Unsupervised use of vehicle equipment can cause an accident and/or serious personal injury.

For more information, see "Power windows" (▷ page 200).

▼ Panic alarm*

An audible alarm and flashing exterior lamps will operate for approximately 2¹/₂ minutes.



① PANIC button



Canada only:
Only vehicles equipped with an anti-theft alarm system* have SmartKeys with integrated panic button ①.

Activating

- ▶ Press and hold button ① for at least one second.

Deactivating

- ▶ Press button ① again.
- or
- ▶ Insert SmartKey in starter switch.



For operation in the USA only:
This device complies with Part 15 of the FCC Rules. Operation is subject to the following two conditions:

- (1) This device may not cause harmful interference, and
- (2) this device must accept any interference received, including interference that may cause undesired operation.

Any unauthorized modification to this device could void the user's authority to operate the equipment.

Safety and Security

Driving safety systems

▼ Driving safety systems

In this section you will find information on the following driving safety systems:

- ABS (Antilock Brake System)
- BAS (Brake Assist System)
- ESP (Electronic Stability Program)
- 4MATIC (Four Wheel Electronic Traction System)



In winter operation, the maximum effectiveness of the ABS, ESP and 4MATIC (if so equipped) is only achieved with winter tires (M+S tires), or snow chains as required.

Warning!



The following factors increase the risk of accidents:

- Excessive speed, especially in turns
- Wet and slippery road surfaces
- Following another vehicle too closely

The ABS, BAS, ESP and 4MATIC (if so equipped) cannot reduce this risk.

Always adjust your driving style to the prevailing road and weather conditions.

ABS

Warning!



Do not pump the brake pedal. Use firm, steady brake pedal pressure instead. Pumping the brake pedal defeats the purpose of the ABS and significantly reduces braking effectiveness.

The Antilock Brake System (ABS) regulates the brake pressure so that the wheels do not lock during braking. This allows you to maintain the ability to steer your vehicle.

The ABS is functional above a speed of approximately 5 mph (8 km/h) independent of road surface conditions.

On slippery road surfaces, the ABS will respond even with light brake pressure.

The  indicator lamp in the instrument cluster (▷ page 22) comes on when you turn the SmartKey in the starter switch to position **2**. It goes out when the engine is running.

Braking

At the instant one of the wheels is about to lock up, a slight pulsation can be felt in the brake pedal, indicating that the ABS is in the regulating mode.

- ▶ Keep firm and steady pressure on the brake pedal while experiencing the pulsation.

Continuous steady brake pedal pressure yields the advantages provided by the ABS, namely braking power and ability to steer the vehicle.

The pulsating brake pedal can be an indication of hazardous road conditions and functions as a reminder to take extra care while driving.

Emergency brake maneuver

- ▶ Keep continuous full pressure on the brake pedal.

Warning!



The ABS cannot prevent the natural laws of physics from acting on the vehicle, nor can it increase braking or steering efficiency beyond that afforded by the condition of the vehicle brakes and tires or the traction. The ABS cannot prevent accidents, including those resulting from excessive speed in turns, following another vehicle too closely, or hydroplaning. Only a safe, attentive, and skillful driver can prevent accidents. The capabilities of an ABS equipped vehicle must never be exploited in a reckless or dangerous manner which could jeopardize the user's safety or the safety of others.

For more information, see "Practical hints" (▷ page 274).

BAS

The Brake Assist System (BAS) operates in emergency situations. If you apply the brakes very quickly, the BAS automatically provides full brake boost, thereby potentially reducing the braking distance. Apply continuous full braking pressure until the emergency braking situation is over. The ABS will prevent the wheels from locking.

When you release the brake pedal, the brakes function again as normal. The BAS is then deactivated.

Safety and Security

Driving safety systems

Warning!



The BAS cannot prevent the natural laws of physics from acting on the vehicle, nor can it increase braking efficiency beyond that afforded by the condition of the vehicle brakes and tires or the traction. The BAS cannot prevent accidents, including those resulting from excessive speed in turns, following another vehicle too closely, or hydroplaning. Only a safe, attentive, and skillful driver can prevent accidents. The capabilities of a BAS equipped vehicle must never be exploited in a reckless or dangerous manner which could jeopardize the user's safety or the safety of others.

For more information, see "Practical hints" (▷ page 281).

ESP

The Electronic Stability Program (ESP) monitors the vehicle's traction (force of adhesive friction between the tires and the road surface) and handling.

The ESP recognizes when a wheel is spinning or if the vehicle starts to skid. By applying brakes to the appropriate wheel and by limiting engine output, the ESP works to stabilize the vehicle. The ESP is especially useful while driving off and on wet or slippery road surfaces.

The ESP warning lamp  in the speedometer flashes when the ESP is engaged.

The ESP warning lamp  in the speedometer comes on when you turn the SmartKey in the starter switch to position **2**. It goes out when the engine is running.

Warning!



Never switch off the ESP when you see the ESP warning lamp  flashing in the speedometer. In this case, proceed as follows:

- While driving off, apply as little throttle as possible.
- While driving, ease up on the accelerator.
- Adapt your speed and driving style to the prevailing road conditions.

Failure to observe these guidelines could cause the vehicle to skid.

The ESP cannot prevent accidents resulting from excessive speed.

Warning!



The ESP cannot prevent the natural laws of physics from acting on the vehicle, nor can it increase the traction afforded. The ESP cannot prevent accidents, including those resulting from excessive speed in turns or hydroplaning. Only a safe, attentive, and skillful driver can prevent accidents. The capabilities of an ESP equipped vehicle must never be exploited in a reckless or dangerous manner which could jeopardize the user's safety or the safety of others.



The ESP will only function properly if you use wheels of the recommended tire size.



Vehicles without 4MATIC:
Because of the ESP's automatic operation, the engine must be shut off (SmartKey in starter switch position **0** or **1**) when

- the parking brake is being tested on a brake test dynamometer
- the vehicle is being towed with the front axle raised

Active braking action through the ESP may otherwise seriously damage the brake system.

For information on vehicles with 4MATIC, see "Four wheel electronic traction system (4MATIC) with the ESP" (▷ page 77).

For more information, see "Practical hints" (▷ page 277) and (▷ page 282).

Switching off the ESP

Warning!



The ESP should not be switched off during normal driving other than in the circumstances described below. Disabling of the system will reduce vehicle stability in standard driving maneuvers.

To improve the vehicle's traction, turn off the ESP in driving situations where it would be advantageous to have the drive wheels spin and thus cut into surfaces for better grip such as:

- starting out on slippery surfaces and in deep snow in conjunction with snow chains
- in sand or gravel

Safety and Security

Driving safety systems

The switch is located on the center console.



- ① ESP off
- ② ESP on

- ▶ Press upper switch position ①.

The ESP warning lamp  in the speedometer comes on.

The ESP is deactivated.

If one or more drive wheels are spinning, the ESP warning lamp  in the speedometer flashes, regardless of the speed.

Traction control brakes a spinning wheel even when the ESP is deactivated.

The ESP always operates when you are braking, even when it has been deactivated.



Avoid spinning of a drive wheel for an extended period with the ESP switched off. This may cause serious damage to the drive train which is not covered by the Mercedes-Benz Limited Warranty.

Warning!



When the ESP warning lamp  is illuminated continuously, the ESP is switched off.

Adapt your speed and driving to the prevailing road conditions and to the non-operating status of the ESP.

Switching on the ESP

- ▶ Press lower switch position ②.

The ESP warning lamp  in the speedometer goes out.

You are now again in normal driving mode.

Four wheel electronic traction system (4MATIC) with the ESP

Models with all-wheel-drive only.

The 4MATIC improves vehicle's ability to use available traction, e.g. during winter operation in mountains under snowy conditions, by applying power to all four wheels.

Warning!



If you see the ESP warning lamp  flashing in the speedometer, proceed as follows:

- While driving off, apply as little throttle as possible
- While driving, ease up on the accelerator
- Adapt your speed and driving style to the prevailing road conditions

Failure to observe these guidelines could cause the vehicle to skid.

The ESP cannot prevent accidents resulting from excessive speed.



Do not tow with one axle raised.

Otherwise the transfer case can be damaged, which is not covered by the Mercedes-Benz Limited Warranty.

Safety and Security

Driving safety systems



Performance testing must only be conducted on a two-axle dynamometer.

Otherwise the transfer case can be damaged, which is not covered by the Mercedes-Benz Limited Warranty.



Because of the ESP's automatic operation, the engine must be shut off (SmartKey in starter switch position **0** or **1**) when the parking brake is being tested on a brake test dynamometer

Active braking action through ESP may otherwise seriously damage the front or rear axle brake system.

Operational tests with the engine running can only be conducted on a two-axle dynamometer.

Safety and Security

Anti-theft systems

▼ Anti-theft systems

Immobilizer

The immobilizer prevents unauthorized persons from starting your vehicle.

Activating

- Removing the SmartKey from the starter switch activates the immobilizer.

Deactivating

- Inserting the SmartKey in the starter switch deactivates the immobilizer.



In case the engine cannot be started (yet the vehicle's battery is charged), the system is not operational. Contact an authorized Mercedes-Benz Center or call 1-800-FOR-MERCEdes (in the USA), or 1-800-387-0100 (in Canada).

Anti-theft alarm system*

Once the alarm system has been armed, a visual and audible alarm is triggered when someone opens

- a door
- the trunk lid
- the hood

The alarm will stay on, even if the activating element (a door, for example) is immediately closed.

The alarm system will also be triggered when

- someone attempts to raise the vehicle
- opening the vehicle with the mechanical key



If the alarm stays on for more than 20 seconds, an emergency call is initiated automatically by the Tele Aid system* (▷ page 223) provided Tele Aid service was subscribed to and properly activated, and that necessary cellular service and GPS coverage are available.

Arming the alarm system

The alarm system is armed after locking the vehicle with the SmartKey. The turn signal lamps flash three times to indicate that the alarm system is activated. A red indicator lamp in the switch for the tow-away alarm (▷ page 79) begins to flash after approx. ten seconds after arming the alarm system.

Safety and Security

Anti-theft systems



If the turn signal lamps do not flash three times, one of the following elements may not be properly closed:

- a door
- the trunk lid

Close the respective element and lock the vehicle again.

Disarming the alarm system

The alarm system is disarmed when you unlock your vehicle with the SmartKey. The turn signal lamps flash once to indicate that the alarm system is deactivated.





The alarm system will rearm automatically after approximately 40 seconds if no door or the trunk lid was opened.

Canceling the alarm

To cancel the alarm:

- ▶ Insert the SmartKey in the starter switch.

or

- ▶ Press the  or  button on the SmartKey.

Tow-away alarm*

Once the tow-away alarm is armed, a visual and audible alarm will be triggered when someone attempts to raise the vehicle.



The tow-away protection alarm is triggered, for example, if the vehicle is lifted on one side.

If the alarm stays on for more than 20 seconds, an emergency call is initiated automatically by the Tele Aid system* (> page 223) provided Tele Aid service was subscribed to and properly activated, and that necessary cellular service and GPS coverage are available.

Safety and Security

Anti-theft systems

Arming tow-away alarm

When you lock your vehicle, the tow-away alarm is automatically armed after about 30 seconds.

When you unlock your vehicle, the tow-away protection disarms automatically.

Disarming tow-away alarm

To prevent triggering the tow-away alarm, switch off the tow-away alarm feature before towing the vehicle, or when parking on a surface subject to movement, such as a ferry or auto train.

The switch is located on the center console.



- ① Tow-away alarm off switch
- ② Indicator lamp

- ▶ Switch off the ignition and remove the SmartKey.





You cannot disarm the tow-away alarm while the ignition is switched on.

- ▶ Press upper switch position ①.
Indicator lamp ② in switch comes on briefly.
- ▶ Exit and lock your vehicle with the SmartKey.

The tow-away alarm remains disarmed until you lock your vehicle again.

Canceling the alarm

To cancel the alarm:

- ▶ Insert the SmartKey in the starter switch.
- or
- ▶ Press the  or  button on the SmartKey.



Controls in detail

Locking and unlocking

Seats

Memory function*

Lighting

Instrument cluster

Control system

Manual transmission

Automatic transmission*

Good visibility

Climate control

Automatic climate control*

Audio system

Power windows

Sliding/pop-up roof*

Driving systems

Loading

Useful features

Controls in detail

Locking and unlocking

In the “Controls in detail” section you will find detailed information on how to operate the equipment installed on your vehicle. If you are already familiar with the basic functions of your vehicle, this section will be of particular interest to you.

To quickly familiarize yourself with the basic functions of the vehicle, refer to the “Getting started” section of this manual. The corresponding page numbers are given at the beginning of each segment.

▼ Locking and unlocking

SmartKey

Your vehicle comes supplied with two SmartKeys, each with remote control and a removable mechanical key. The locking tabs for the mechanical key portion of the two SmartKeys are a different color to help distinguish each SmartKey unit.

The SmartKey provides an extended operating range. To prevent theft, however, it is advisable to only unlock the vehicle when you are in close proximity to it.

The SmartKey centrally locks and unlocks:

- the doors
- the trunk
- the fuel filler flap



You can also open and close the power windows (▷ page 202) and sliding/pop-up roof* (▷ page 204) from outside using the SmartKey.

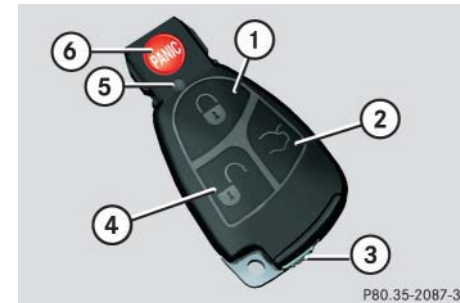

SmartKey with remote control

- ① Lock button
- ② Opening button for the trunk lid
- ③ Mechanical key locking tab
- ④ Unlock button
- ⑤ Battery check lamp
- ⑥ PANIC button* (▷ page 71).



Canada only:
Only vehicles equipped with an anti-theft alarm system* have SmartKeys with integrated panic button* ⑥.



To prevent possible malfunction, avoid exposing the SmartKey to high levels of electromagnetic radiation.

Factory setting

Global unlocking

- ▶ Press button

All turn signal lamps flash once. The locking knobs in the doors move up.

The vehicle will lock again automatically within approximately 40 seconds of unlocking if:

- neither door nor trunk is opened
- the SmartKey is not inserted in the starter switch
- the central locking switch is not activated

Global locking

- ▶ Press button

All turn signal lamps flash three times. The locking knobs in the doors move down.

Selective setting

If you frequently travel alone, you may wish to reprogram the SmartKey so that pressing only unlocks the driver's door and the fuel filler flap.

- ▶ Press and hold buttons and simultaneously for about five seconds until battery check lamp flashes twice.

The SmartKey will then function as follows:

Unlocking driver's door and fuel filler flap

- ▶ Press button once.

Controls in detail

Locking and unlocking

Global unlocking

- ▶ Press button twice.

Global locking

- ▶ Press button .

Restoring to factory setting

- ▶ Press and hold buttons and simultaneously for about six seconds until battery check lamp flashes twice.

Warning!



When leaving the vehicle, always remove the SmartKey from the starter switch, take it with you and lock the vehicle. Do not leave children unattended in the vehicle, or with access to an unlocked vehicle. It is possible for children to open a locked door from the inside, which could result in an accident and/or serious injury.

Controls in detail

Locking and unlocking





If you can no longer lock or unlock the vehicle with the SmartKey, then either the batteries in the SmartKey are discharged, the SmartKey is malfunctioning or the vehicle battery is drained.

- Check the batteries in the SmartKey (▷ page 84) and replace them if necessary (▷ page 307).
or
- Use the mechanical key to unlock the doors (▷ page 305) and the trunk lid (▷ page 306) as required.
or
- Use the mechanical key to lock the doors (▷ page 306) and the trunk lid (▷ page 306) as required.
or
- Have the vehicle battery and the battery connections checked.

If the SmartKey is malfunctioning, contact an authorized Mercedes-Benz Center.

Checking the batteries

- ▶ Press button  or .

Battery check lamp  comes on briefly to indicate that the SmartKey batteries are in order.





If battery check lamp  does not come on briefly during check, then the SmartKey batteries are discharged.

Replace the batteries (▷ page 307).

You can obtain the required batteries at any authorized Mercedes-Benz Center.



If the batteries are checked within signal range of the vehicle, pressing the  or  button will lock or unlock the vehicle accordingly.

Unlocking and opening the trunk lid

You can unlock and open the trunk separately.

A minimum height clearance of 5.71 ft (1.74 m) is required to open the trunk lid.

- ▶ Press button  until trunk unlocks and begins to open.



The trunk lid swings open upwards automatically. Always make sure there is sufficient overhead clearance.

The trunk can also be opened from its inside in an emergency, see “Trunk lid emergency release” (▷ page 88).



If the trunk lid does not open, it is still locked separately (if applicable) (▷ page 89).

If the vehicle was previously centrally locked, the trunk lid will lock automatically when closed (▷ page 87). The turn signals will flash three times to confirm locking.

Loss of SmartKey or mechanical key

If you lose a SmartKey or mechanical key, you should do the following:

- ▶ Have the SmartKey deactivated by an authorized Mercedes-Benz Center.
- ▶ Report the loss of the SmartKey or the mechanical key immediately to your car insurance company.
- ▶ If necessary, have the mechanical lock replaced.

Your authorized Mercedes-Benz Center will be glad to supply you with a replacement.

Controls in detail

Locking and unlocking

Opening the doors from the inside

You can open a locked door from the inside. Open door only when conditions are safe to do so.



① Locking knob

② Inside door handle

- ▶ Pull on door handle ②.

If door was locked, locking knob ① will move up.



Controls in detail

Locking and unlocking



If the vehicle has previously been locked from the outside with the SmartKey, opening a door from the inside will trigger the anti-theft alarm system*.

To cancel the alarm, do one of the following:

- Press button  or  on the SmartKey.
- Insert the SmartKey in the starter switch.

Opening the trunk

Opening the trunk from the outside

A minimum height clearance of 5.71 ft (1.74 m) is required to open the trunk lid.

The handle is located above the rear license plate recess.

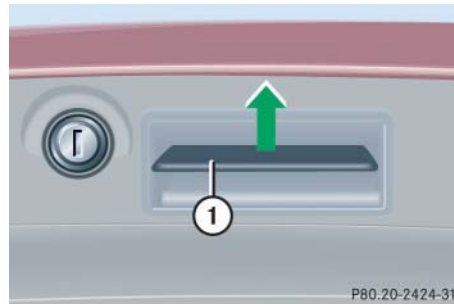

① Handle

- ▶ Pull on handle ①.

The trunk opens.



The trunk lid swings open upwards automatically. Always make sure there is sufficient overhead clearance.



If the trunk lid does not open, it is still locked separately (if applicable) (▷ page 89).

The vehicle must be unlocked.

The trunk can also be opened using the SmartKey, see “Unlocking and opening the trunk lid” (▷ page 84) or from its inside in an emergency, see “Trunk lid emergency release” (▷ page 88).

Opening the trunk from the inside

You can open the trunk from the inside if the vehicle is stationary.

A minimum height clearance of 5.71 ft (1.74 m) is required to open the trunk lid.

The switch is located on the driver's door.



① Remote trunk lid switch with indicator lamp

- ▶ Press remote trunk lid switch ①.

The trunk lid opens. The indicator lamp in the switch remains lit as long as the trunk is open.



The trunk lid swings open upwards automatically. Always make sure there is sufficient overhead clearance.



If the trunk lid does not open, it is still locked separately (if applicable) (▶ page 89).

If the vehicle was previously centrally locked, the trunk lid will lock automatically when closed (▶ page 87). The turn signals will flash three times to confirm locking.

The trunk can also be opened using the SmartKey, see “Unlocking and opening the trunk lid” (▶ page 84) or from its inside in an emergency, see “Trunk lid emergency release” (▶ page 88).

Controls in detail

Locking and unlocking

Closing the trunk

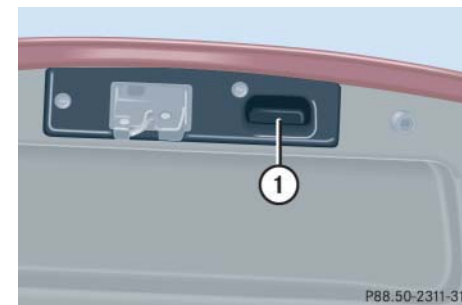

① Handle

- ▶ Lower trunk lid using handle ①.
- ▶ Close trunk lid with hands placed flat on it.

Warning!



To prevent possible personal injury, always keep hands and fingers away from the trunk opening when closing the trunk. Be especially careful when small children are around.

Controls in detail

Locking and unlocking

Warning!



Only drive with the trunk closed. Among other dangers, such as your view being blocked, exhaust fumes may enter the vehicle interior.



Do not place the SmartKey in the open trunk. You may lock yourself out.

Trunk lid emergency release

The emergency release button is located on the inside of the trunk lid.

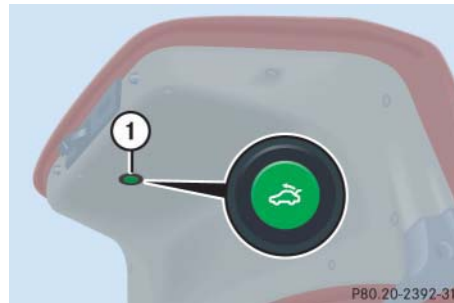

① Emergency release button

- ▶ Briefly press emergency release button ①.

The trunk unlocks and the trunk lid opens.



The trunk lid swings open upwards automatically.



The emergency release button unlocks and opens the trunk while the vehicle is standing or driving.



Illumination of the emergency release button:

- The button will flash for 30 minutes after opening the trunk.
- The button will flash for 60 minutes after closing the trunk.

i The emergency release button does not open the trunk lid if the vehicle battery is discharged or disconnected.

i If the emergency release button is pressed and the vehicle was centrally locked, the exterior lamps will flash and the alarm will sound as the trunk lid opens.

To cancel the alarm, do one of the following:

- Press button  or  on the SmartKey.
- Insert the SmartKey in the starter switch.

Separately locking the trunk

i Your vehicle may be equipped with a function permitting the separate locking of the trunk using the mechanical key. If present, this feature can permit you to deny any unauthorized person access to the trunk by locking the trunk separately and leaving the SmartKey less the mechanical key with the vehicle.

To verify the presence of this feature, use the mechanical key to lock the trunk and then attempt to open the trunk by pulling on the trunk lid handle after the vehicle has been centrally unlocked with the SmartKey.

Controls in detail

Locking and unlocking

The lock is located next to the recessed handle.

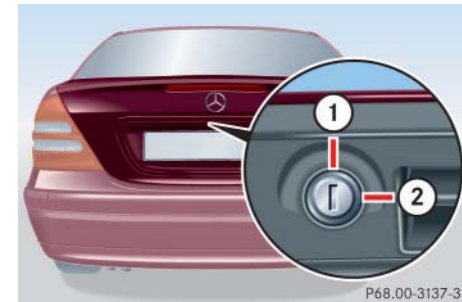

- ① Neutral position
- ② Locked

- ▶ Close the trunk lid (▷ page 87).
- ▶ Pull the mechanical key out of the SmartKey (▷ page 305).
- ▶ Insert the mechanical key in the trunk lid lock.
- ▶ Turn the mechanical key clockwise to position ②.

The trunk remains locked even when the vehicle is centrally unlocked.

Controls in detail

Locking and unlocking



You can only cancel the separate trunk locking mode by means of the mechanical key.

Separately unlocking the trunk

- ▶ Pull the mechanical key out of the SmartKey (▷ page 305).
- ▶ Insert the mechanical key in the trunk lid lock.
- ▶ Turn the mechanical key counterclockwise to neutral position ① (▷ page 89).

You can now open the trunk (▷ page 86).

A minimum height clearance of 5.71 ft (1.74 m) is required to open the trunk lid.

Warning!



Only drive with the trunk closed. Among other dangers, such as your view being blocked, exhaust fumes may enter the vehicle interior.

Automatic central locking

The doors and the trunk automatically lock when the ignition is switched on and the wheels are turning at vehicle speeds of approximately 9 mph (15 km/h) or more.

You can open a locked door from the inside. Open door only when conditions are safe to do so.



The doors unlock automatically after an accident if the force of the impact exceeds a preset threshold.

The vehicle automatically locks when the ignition is switched on and the wheels are turning at vehicle speeds of approximately 9 mph (15 km/h) or more. You could therefore lock yourself out when the vehicle

- is pushed or towed
- is on a test stand

For more information on towing the vehicle, see see “Towing the vehicle” (▷ page 328).

You can deactivate the automatic locking mode using the control system, see “Setting automatic locking” (▷ page 133).

Controls in detail

Locking and unlocking

Locking and unlocking from the inside

You can lock or unlock the doors and the trunk from inside using the central locking switch. This can be useful, for example, if you want to lock the vehicle before starting to drive.

The fuel filler flap will not be locked or unlocked with the central locking switch.

Warning!



When leaving the vehicle, always remove the SmartKey from the starter switch, take it with you and lock the vehicle. Do not leave children unattended in the vehicle, or with access to an unlocked vehicle. Unsupervised use of vehicle equipment may cause an accident and/or serious personal injury.

The switch is located in the center console.



Central locking switch

- ① Locking
- ② Unlocking

Locking

- ▶ Press upper switch position ① of central locking switch.

If all doors are closed, the vehicle locks.

Unlocking

- ▶ Press lower switch position ② of central locking switch.

The vehicle unlocks.



You can open a locked door from the inside. Open door only when conditions are safe to do so.

If the vehicle was previously centrally locked using the SmartKey, it will not unlock using the central locking switch.

If the vehicle was previously locked with the central locking switch

- while in the selective remote control mode, only the door opened from the inside is unlocked.
- while in the global remote control mode, the complete vehicle is unlocked when a door is opened from the inside.

Controls in detail

Seats

▼ Seats

For information on seat adjustment, see “Seats” (▷ page 32).

Easy-entry/exit feature*

With the easy-entry/exit feature activated, the steering wheel tilts upwards and the driver’s seat moves to the rear.

This allows easier entry into and exit from the vehicle when the driver’s door is opened. However, the engine must be turned off.

When the SmartKey is inserted in the starter switch and the driver’s door is closed, the steering wheel and the driver’s seat return to their last set positions.

Warning!



You must make sure no one can become trapped or injured by the moving steering wheel and the driver’s seat when the easy-entry/exit feature* is activated, the driver’s door is being opened and the engine is turned off or the SmartKey is removed from the starter switch.

Do not leave children unattended in the vehicle, or with access to an unlocked vehicle. Children could open the driver’s door and unintentionally activate the easy-entry/exit feature*, which could result in an accident and/or serious personal injury.

You can activate the following functions:

- Steering column:
Only the steering column is adjusted.
- Steering column and seat:
The steering column and the seat are adjusted.

The easy-entry/exit feature can be switched on or off in the convenience submenu of the control system (▷ page 133).



To cancel seat/steering wheel movement, do one of the following:

- Press the seat adjustment switch* (▷ page 28)
- Move the steering column stalk* (▷ page 37)
- Press the memory button* (▷ page 28)

Removing and installing front seat head restraints

For information on head restraint adjustment, see “Seats” (▷ page 32).

Warning!



For your protection, drive only with properly positioned head restraints.

Adjust head restraint so that the head restraint supports the back of the head at eye level. This will reduce the potential for injury to the head and neck in the event of an accident or similar situation.

Do not drive the vehicle without the seat head restraints. Head restraints are intended to help reduce injuries during an accident.

Do not interchange head restraints from front and rear seat.



Tilt the backrest to the rear for easier removal and installation of the head restraints.

Front seat head restraints, manual seat

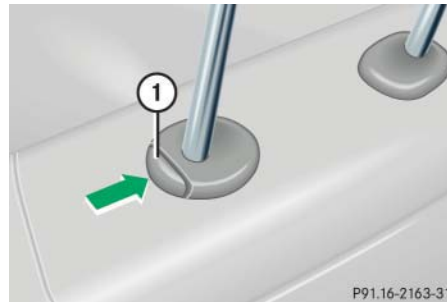

① Release button

Removing front seat head restraints

- ▶ Pull head restraint to its highest position.
- ▶ Push release button ① and pull out head restraint.

Installing front seat head restraints

- ▶ Insert head restraint and push it down until it engages.
- ▶ Push release button ① and adjust head restraint to desired position.

Controls in detail

Seats

Front seat head restraints, power seat*

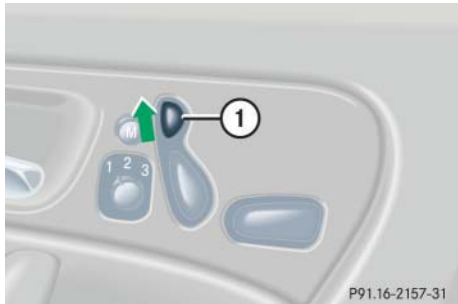

Removing front seat head restraints

- ▶ Press switch ① upwards and hold until head restraint is fully extended.
- ▶ Pull out head restraint.

Installing front seat head restraints

- ▶ Press switch ① upwards and hold for about five seconds.
- ▶ Push head restraint down until it engages.
- ▶ Adjust head restraint to desired position (▷ page 35).

Rear seat head restraints

Head restraint height (rear outer seats)

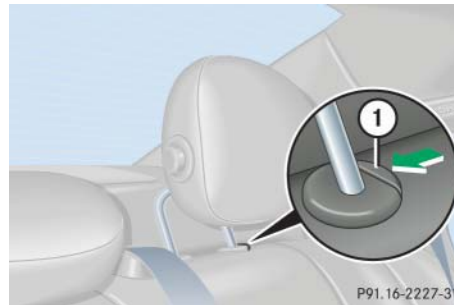

① Release button

Raising:

- ▶ Manually adjust the height of the head restraint by pulling it upward.

If the head restraint is fully retracted, push release button ① and pull the head restraint out.

Lowering:

- ▶ To lower the head restraint, push release button ① and push down on the head restraint.

Warning!



For your protection, drive only with properly positioned head restraints.

Adjust head restraint so that the head restraint supports the back of the head at eye level. This will reduce the potential for injury to the head and neck in the event of an accident or similar situation.

Do not drive the vehicle without the seat head restraints. Head restraints are intended to help reduce injuries during an accident.



The center rear seat head restraint cannot be adjusted.

Folding head restraints back with release button

The rear seat head restraints can be folded backward for increased visibility.

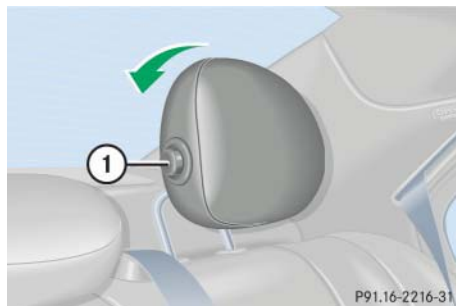

① Release button

- ▶ Push release button ①.

The head restraints will fold backward.



You can also fold the head restraints back using the switch in the center console (> page 95).

Folding head restraints back with switch in the center console



① Head restraint release switch

- ▶ Start the engine.
- ▶ Press the symbol-side on the rocker switch ① to release the head restraints.

The head restraints will fold backward.

Warning!



For safety reasons, always drive with the rear head restraints in the upright position when the rear seats are occupied.

Keep the area around head restraints clear of articles (e.g. clothing) to not obstruct the folding operation of the head restraints.

Placing head restraints upright

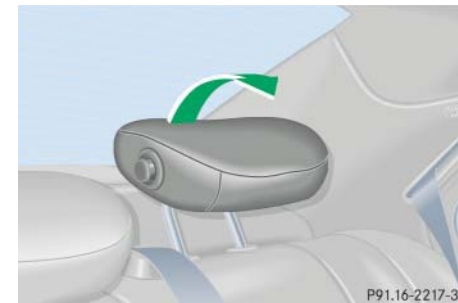

- ▶ Pull the head restraint forward until it locks into position.

Controls in detail

Seats



Make sure the head restraints engage when placing them upright. Otherwise their protective function cannot be assured.

Head restraint tilt

Two different head restraint angle positions are available.

- ▶ Press the release button (▷ page 95) and tilt the head restraint to the desired position.

Removing and installing rear seat head restraints (outer seats)

Warning!



For your protection, drive only with properly positioned head restraints.

Adjust head restraint so that the head restraint supports the back of the head at eye level. This will reduce the potential for injury to the head and neck in the event of an accident or similar situation.

Do not drive the vehicle without the seat head restraints. Head restraints are intended to help reduce injuries during an accident.

Do not interchange head restraints from front and rear seat.



The center rear seat head restraint cannot be removed.

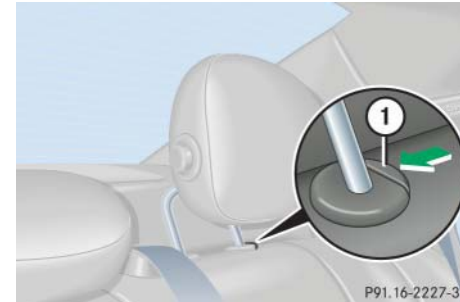

- ① Release button

Removing rear seat head restraints

- ▶ Fold back head restraint (▷ page 95).
- ▶ Pull head restraint to its highest position.
- ▶ Push release button ① and pull out head restraint.

Installing rear seat head restraints

- ▶ Insert head restraint and push it down until it engages.
- ▶ Push button ① and adjust head restraint to desired position.

Multicontour seat*

This multicontour seat has a movable seat cushion and inflatable air cushions built into the backrest to provide additional lumbar and side support.

The seat cushion movement, backrest cushion height and curvature can be continuously varied with switches on the right side of the seat after starting the engine.

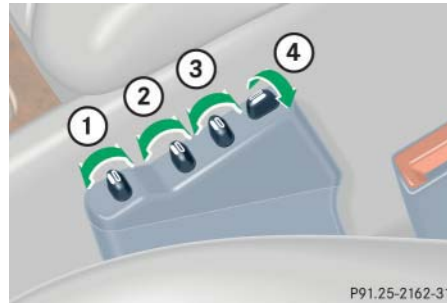

- ① Seat cushion depth
- ② Backrest bottom
- ③ Backrest center
- ④ Backrest side bolster adjustment

- ▶ Start the engine.

Seat cushion depth

- ▶ Adjust the seat cushion depth to the length of your upper leg using switch ①.

Backrest contour

- ▶ Adjust the contour of the backrest to the desired position using switches ② and ③.

Backrest side bolsters

- ▶ Adjust the backrest side bolsters so that they provide good lateral support using switch ④.

Controls in detail

Seats

Heated seats*

Both switches for the front seats are located in the center console.



① Normal heating

② Rapid heating

- ▶ Make sure the ignition is switched on.
All the lamps in the instrument cluster come on.

Switching on seat heating

- ▶ Press upper switch position ①.

A red indicator lamp on the switch comes on.

Switching off seat heating

- ▶ Press upper switch position ① again.



The seat heater will be automatically switched off after approximately 30 minutes.

Switching on rapid seat heating

- ▶ Press lower switch position ②.

Both red indicator lamps on switch come on.



The system switches over to normal heating mode after approximately five minutes. Only one indicator lamp remains lit.

Switching off rapid seat heating

- ▶ Press lower switch position ② again.



If one or both of the indicator lamps on the seat heater switch are flashing, there is insufficient voltage available since too many electrical consumers are turned on. The seat heater switches off automatically.

The seat heater will switch back on again automatically as soon as sufficient voltage is available.

▼ Memory function*



Prior to operating the vehicle, the driver should check and adjust the seat height, seat position fore and aft, and seat backrest angle if necessary, to ensure adequate control, reach and comfort. The head restraint should also be adjusted for proper height. See also the section on airbags (▷ page 55) for proper seat positioning.

In addition, adjust the steering wheel to ensure adequate control, reach, operation and comfort. Both the interior and exterior rear view mirrors should be adjusted for adequate rear vision.

Fasten seat belts. Infants and small children should be seated in a properly secured restraint system that complies with U.S. Federal Motor Vehicle Safety Standards 213 and 225 and Canadian Motor Vehicle Safety Standards 213 and 210.2.

The memory button and stored position switch are located on the door.

You can store up to three different settings per SmartKey.

The following settings are saved for each stored position:

- Driver's seat and backrest position
- Steering wheel position
- Driver's side exterior rear view mirror position
- Passenger side exterior rear view mirror position
- Front passenger seat position

These key-dependent memory settings can be deactivated if desired (▷ page 135).

Controls in detail

Memory function*

Warning!



Do not activate the memory function while driving. Activating the memory function while driving could cause the driver to lose control of the vehicle.

Controls in detail

Memory function*

The memory button and stored position button are located on the door.

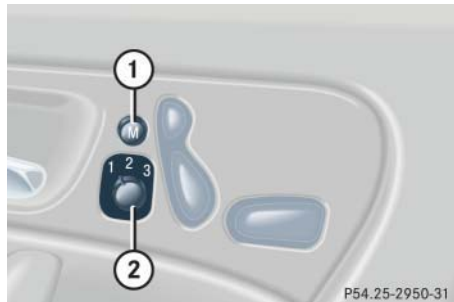

- ① Memory button
- ② Stored position button

- ▶ Make sure the ignition is switched on or the relevant door is open and the SmartKey is inserted in the starter switch.

Storing positions into memory

- ▶ Adjust the seats, steering wheel and rear view mirrors to the desired position (▷ page 32).
- ▶ Turn button ② to selected memory position.
- ▶ Press memory button ①.
- ▶ Release memory button and push button ② within three seconds.

All the settings are stored at the selected position.

Recalling positions from memory

- ▶ Turn button ② to selected memory position.
- ▶ Press and hold button ② until the seat, steering wheel and rear view mirrors have fully moved to the stored positions.



Releasing the button immediately stops movement to the stored positions.

Warning!



Do not operate the power seats using the memory button if the seat backrest is in an excessively reclined position. Doing so could cause damage to front or rear seats.

First move backrest to an upright position.

Storing exterior rear view mirror parking position

For easier parking, you can adjust the passenger-side exterior rear view mirror so that you can see the right rear wheel as soon as you engage reverse gear **R**.

For information on activating the parking position feature, see “Setting parking position* for exterior rear view mirror” (> page 136).



You can store a parking position for the passenger-side exterior rear view mirror for each SmartKey.



- ① Memory button
- ② Adjustment button
- ③ Passenger-side exterior rear view mirror button

- ▶ Stop the vehicle.
- ▶ Switch on ignition (if not already on).
- ▶ Press button ③.

The passenger-side exterior rear view mirror is selected.

Controls in detail

Memory function*

- ▶ Adjust the exterior rear view mirror with button ② so that you see the rear wheel and the road curb.
- ▶ Press memory button ①.
- ▶ Within three seconds, press bottom of adjustment button ②.

The parking position is stored if the mirror does not move.



If the mirror does move, repeat the above steps. After the setting is stored, you can move the mirror again.

Controls in detail

Lighting

▼ Lighting

For notes on how to switch on the headlamps and use the turn signals, see the “Getting started” section (▷ page 46).



If you drive in countries where vehicles drive on the other side of the road than the country where the vehicle is registered, you must have the headlamps modified for symmetrical low beams. Relevant information can be obtained at your authorized Mercedes-Benz Center.

Exterior lamp switch

The exterior lamp switch is located on the dashboard to the left of the steering wheel.



- 0** Off
- AUTO** Automatic headlamp mode
- P** Parking lamps (also side marker lamps, tail lamps, license plate lamps, instrument panel lamps)
Canada only:
When engine is running, the low beam is also switched on.
- D** Low beam plus parking lamps or high beam headlamps (combination switch pushed forward).
- P<** Standing lamps, right (turn left one stop)
- >P** Standing lamps, left (turn left two stops)



If you remove the SmartKey and open the driver's door while the parking lamps or low beam headlamps are switched on, then

- a warning sounds
-  appears in the multifunction display
- the message **TURN OFF LIGHTS!** appears in the multifunction display



With the daytime running lamp mode activated and the engine running, the low beam headlamps cannot be switched off manually.

Manual headlamp mode

The low beam headlamps and parking lamps can be switched on and off with the exterior lamp switch. For exterior lamp switch, see (▷ page 102).

Automatic headlamp mode

The parking lamps, low beam headlamps and license plate lamps switch on and off automatically depending on the brightness of the ambient light.

- ▶ Turn the exterior lamp switch to **AUTO**.

Warning!





If the exterior lamp switch is set to **AUTO**,

- the headlamps may switch off unexpectedly when the system senses bright ambient light, for example light from oncoming traffic.
- the headlamps will not be automatically switched on under foggy conditions.

Controls in detail

Lighting

To minimize risk to you and to others, activate headlamps by turning exterior lamp switch to  when driving or when traffic and /or ambient lighting conditions require you to do so.

In low ambient lighting conditions, only switch from position **AUTO** to  with the vehicle at a standstill. Switching from **AUTO** to  will briefly switch off the headlamps. Doing so while driving in low ambient lighting conditions may result in an accident.

The automatic headlamp feature is only an aid to the driver. The driver is responsible for the operation of the vehicle's lights at all times.

Controls in detail

Lighting



With the daytime running lamp mode activated, the low beam headlamps will not switch off automatically.



The front fog lamps and rear fog lamp cannot be switched on manually with exterior lamp switch in position **AUTO**. To activate the fog lamps, turn exterior lamp switch to position  and pull the exterior lamp switch to first or second stop (▷ page 102).

Daytime running lamp mode

- ▶ Turn exterior lamp switch to position **0** or **AUTO**.

When the engine is running, the low beam headlamps are automatically switched on. In low ambient light conditions the parking lamps will also switch on.

Canada only

When you shift from a driving position to position **N** or **P**, the low beam switches off (with a three-minute delay).

For nighttime driving you should turn the exterior lamp switch to position  to permit activation of the high beam headlamps.

USA only

The high beam headlamps can also be activated when driving with the daytime running lamp mode activated and exterior lamp switch in position **0**.

To activate the daytime running lamp mode, see “Setting daytime running lamp mode (USA only)” (▷ page 129).



See notes on the exterior lamp switch (▷ page 102).



Locator lighting and night security illumination

Locator lighting and night security illumination are described in the control system section under “Setting locator lighting” (▷ page 130) and “Setting night security illumination” (▷ page 131).

Switching on fog lamps

Warning!



In low ambient lighting or foggy conditions, only switch from position **AUTO** to  with the vehicle at a standstill. Switching from **AUTO** to  will briefly switch off the headlamps. Doing so while driving in low ambient lighting conditions may result in an accident.



Fog lamps will operate with the parking lamps and/or the low beam headlamps on. Fog lamps should only be used in conjunction with low beam headlamps. Consult your State or Province Motor Vehicle Regulations regarding allowable lamp operation.



The front fog lamps and rear fog lamp cannot be switched on manually with exterior lamp switch in position **AUTO**. To activate the fog lamps, turn exterior lamp switch to position  and pull the exterior lamp switch to first or second stop (> page 102).

Switching on front fog lamps

- ▶ Make sure the low beam headlamps are switched on.
- ▶ Pull out exterior lamp switch to first stop.

The green indicator lamp  beside the lamp switch comes on.

Switching on rear fog lamp

- ▶ Make sure the low beam headlamps are switched on.
- ▶ Pull out exterior lamp switch to second stop.

The yellow indicator lamp  beside the lamp switch comes on.

Controls in detail

Lighting

Combination switch

The combination switch is located on the left side of the steering column.

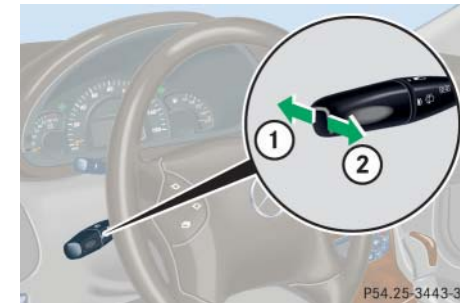



- ① High beam
- ② High beam flasher

Controls in detail

Lighting

Switching on high beams

- ▶ Turn exterior lamp switch to position  or to **AUTO** (▷ page 102).
- ▶ Push combination switch in direction of arrow ①.
The high beam indicator  on the instrument cluster comes on.

High beam flasher

- ▶ Pull combination switch briefly in direction of arrow ②.

Hazard warning flasher

The hazard warning flasher can be activated with the ignition switched on or off. It is activated automatically when an airbag is deployed.

The switch is located on the center console.



① Hazard warning flasher switch

Switching on the hazard warning flasher

- ▶ Press hazard warning flasher switch.
All turn signals will flash.



With the hazard warning flasher activated and the combination switch set for either left or right turn, only the respective left or right turn signals will operate when the SmartKey in the starter switch is in position 1 or 2.

Switching off the hazard warning flasher

- ▶ Press hazard warning flasher switch again.



If the hazard warning flasher was activated automatically, also press switch ① to switch off the hazard warning flasher.

Interior lighting

The controls are located in the overhead control panel.



- ① Rear interior lights
- ② Right front reading lamp
- ③ Rocker switch for automatic control system
- ④ Left front reading lamp

Activating automatic control

- ▶ Press rocker switch ③ to center position.

Interior lamps are switched on in darkness, even when you:

- unlock the vehicle
- open a door
- remove the SmartKey from the starter switch

The interior lamps are switched off after a preset time (▷ page 132).



If the door remains open, the interior lamps switch off automatically after approximately five minutes, when the SmartKey is removed or in starter switch position 0.

An interior lamp switched on manually does not go out automatically.

Deactivating automatic control

- ▶ Press the  symbol on rocker switch ③.

The interior lighting remains switched off, even when you:

- unlock the vehicle
- open a door
- remove the SmartKey from the starter switch

Manual control

Switching all front interior lights on and off

- ▶ Press the  symbol on rocker switch ③.



The front interior lights come on.

- ▶ Press rocker switch ③ to center position to activate the automatic control.



Controls in detail

Lighting



Switching rear interior lights on and off

- ▶ Press button .
The lights in the rear passenger compartment come on.
- ▶ Press button  again.
The lights in the rear passenger compartment go out.

Switching right front reading lamp on and off

- ▶ Press right button .
The right reading lamp comes on.
- ▶ Press right button  again.
The right reading lamp goes out.

Switching left front reading lamp on and off

- ▶ Press left button .
The left reading lamp comes on.
- ▶ Press left button  again.
The left reading lamp goes out.

Door entry lamps

The appropriate door entry lamp switches on if a door is opened in darkness and if the interior lighting is switched to automatic function.

The entry lamp switches off automatically when the door is closed.



If you turn the SmartKey in the starter switch to position **0** and switch off the exterior headlamps, the door entry lamps will remain lit for approximately five minutes.

Trunk lamp

The trunk lamp switches on if the trunk lid is opened.

If you leave the trunk open for an extended period of time, the trunk lamp will switch off automatically after approximately ten minutes.

▼ Instrument cluster

For a full view illustration of the instrument cluster, see “At a glance” (▷ page 22).

The instrument cluster is activated when you

- open a door
- turn on the ignition
- press the reset button (▷ page 22)
- switch on the exterior lamps

You can change the instrument cluster settings in the Instrument cluster submenu of the control system (▷ page 126).

Instrument cluster illumination

Use the reset button (▷ page 22) to adjust the illumination brightness for the instrument cluster.



The instrument cluster illumination is dimmed or brightened automatically to suit ambient light conditions.

The instrument cluster illumination will also be adjusted automatically when you switch on the vehicle’s exterior lamps.

Controls in detail

Instrument cluster

To brighten illumination

- ▶ Turn the reset button in the instrument cluster clockwise (▷ page 22).

The instrument cluster illumination will brighten.

To dim illumination

- ▶ Turn the reset button in the instrument cluster counterclockwise (▷ page 22).

The instrument cluster illumination will dim.

Controls in detail

Instrument cluster

Coolant temperature display

Warning!





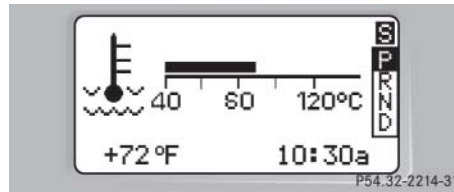

- Driving when your engine is badly overheated can cause some fluids which may have leaked into the engine compartment to catch fire. You could be seriously burned.
- Steam from an overheated engine can cause serious burns and can occur just by opening the hood. Stay away from the engine if you see or hear steam coming from it.

Turn off the engine, get out of the vehicle and do not stand near the vehicle until the engine has cooled down.



Turn the SmartKey in the starter switch to position **1** or **2**.

- ▶ Call up the trip odometer and main odometer by pressing button  or  on the multifunction steering wheel (▷ page 114).
- ▶ Press button  or  until the coolant temperature display appears.





Excessive coolant temperature triggers a warning in the multifunction display.

During severe operating conditions, e.g. stop-and-go traffic, the coolant temperature may rise close to 248°F (120°C).

The engine should not be operated with the coolant temperature above 248°F (120°C). Doing so may cause serious engine damage which is not covered by the Mercedes-Benz Limited Warranty.

Trip odometer

- ▶ Make sure you are viewing the trip odometer and main odometer in the multifunction display (▷ page 113).
- ▶ If it is not displayed, press button  or  on the multifunction steering wheel until the trip odometer appears (▷ page 114).
- ▶ Press and hold the reset button on the instrument cluster (▷ page 22) until the trip odometer is reset.

Tachometer

The red marking on the tachometer denotes excessive engine speed.



Avoid driving at excessive engine speeds, as it may result in serious engine damage that is not covered by the Mercedes-Benz Limited Warranty.

To help protect the engine, the fuel supply is interrupted if the engine is operated within the red marking.

Outside temperature indicator

Warning!



The outside temperature indicator is not designed to serve as an ice-warning device and is therefore unsuitable for that purpose.

Indicated temperatures just above the freezing point do not guarantee that the road surface is free of ice. The road may still be icy, especially in wooded areas or on bridges.

The outside temperature is indicated in the multifunction display (▷ page 23). For information on how to select the unit of the indicated temperature, i.e. degrees Celsius (°C) or degrees Fahrenheit (°F), see “Selecting temperature display mode” (▷ page 127).

Controls in detail

Instrument cluster

The temperature sensor is located in the front bumper area. Due to its location, the sensor can be affected by road or engine heat during idling or slow driving. This means that the accuracy of the displayed temperature can only be verified by comparison to a thermometer placed next to the sensor, not by comparison to external displays (e.g. bank signs, etc.).

When moving the vehicle into colder ambient temperatures (e.g. when leaving your garage), you will notice a delay before the lower temperature is displayed.

A delay also occurs when ambient temperatures rise. This prevents inaccurate temperature indications caused by heat radiated from the engine during idling or slow driving.

▼ Control system

The control system is activated as soon as the SmartKey in the starter switch is turned to position **1**. The control system enables you to

- call up information about your vehicle
- change vehicle settings

For example, you can use the control system to find out when your vehicle is next due for service, to set the language for messages in the instrument cluster display, and much more.



The displays for the audio systems (radio, CD player, cassette player) will appear in English, regardless of the language selected.

Warning!



A driver's attention to the road and traffic conditions must always be his/her primary focus when driving.

For your safety and the safety of others, selecting features through the multifunction steering wheel should only be done by the driver when traffic and road conditions permit it to be done safely.

Bear in mind that at a speed of just 30 mph (approximately 50 km/h), your vehicle is covering a distance of 44 feet (approximately 13.5 m) every second.

The control system relays information to the multifunction display.

Controls in detail

Control system

Multifunction display

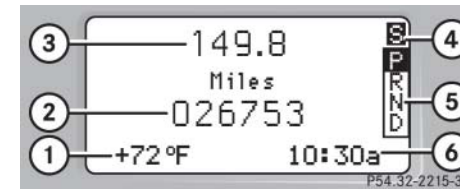

- ① Outside temperature
- ② Main odometer
- ③ Trip odometer
- ④ Automatic transmission program mode
- ⑤ Current gear selector lever position
- ⑥ Digital clock

Controls in detail

Control system

Multifunction steering wheel

The displays in the multifunction display and the settings in the control system are controlled by the buttons on the multifunction steering wheel.

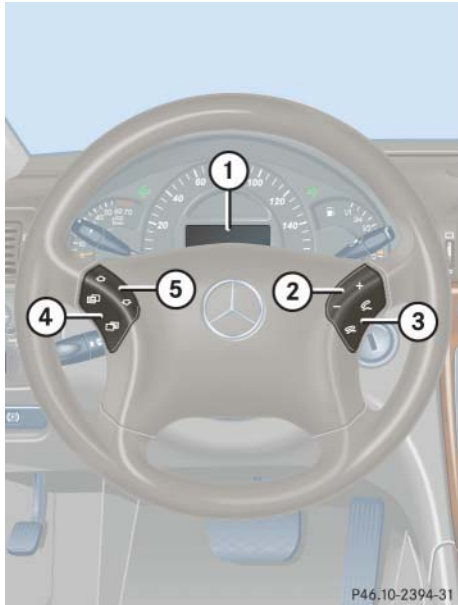





- ① Multifunction display in the speedometer
- ② **Operating the control system**
Selecting the submenu or setting the volume
 - down/to decrease
 - + up/to increase
- ③ Telephone*
 - ☎ to take a call
 - ☎ to end a call
- ④ Menu systems
 - ☰ for next menu
 - ☰ for previous menu
- ⑤ Moving within a menu
 - ⬆ for next display
 - ⬇ for previous display

Pressing any of the buttons on the multifunction steering wheel will alter what is shown in the multifunction display.

The information available in the multifunction display is arranged in menus, each containing a number of functions or sub-menus.

The individual functions are then found within the relevant menu (radio or CD operations under AUDIO, for example). These functions serve to call up relevant information or to customize the settings for your vehicle.

It is helpful to think of the menus, and the functions within each menu, as being arranged in a circular pattern.

- If you press button  or  repeatedly, you will pass through each menu one after the other.
- If you press button  or  repeatedly, you will pass through each function display, one after the other, in the current menu.

In the **SETTINGS** menu, instead of functions you will find a number of submenus for calling up and changing settings. For instructions on using these submenus, see “Submenus in the Settings menu” (▷ page 124).

The number of menus available in the system depends on which optional equipment is installed in your vehicle.

The menus are described on the following pages.

Controls in detail

Control system

Menus

This is what you will see when you scroll through the menus.

The table on the next page provides an overview of the individual menus.

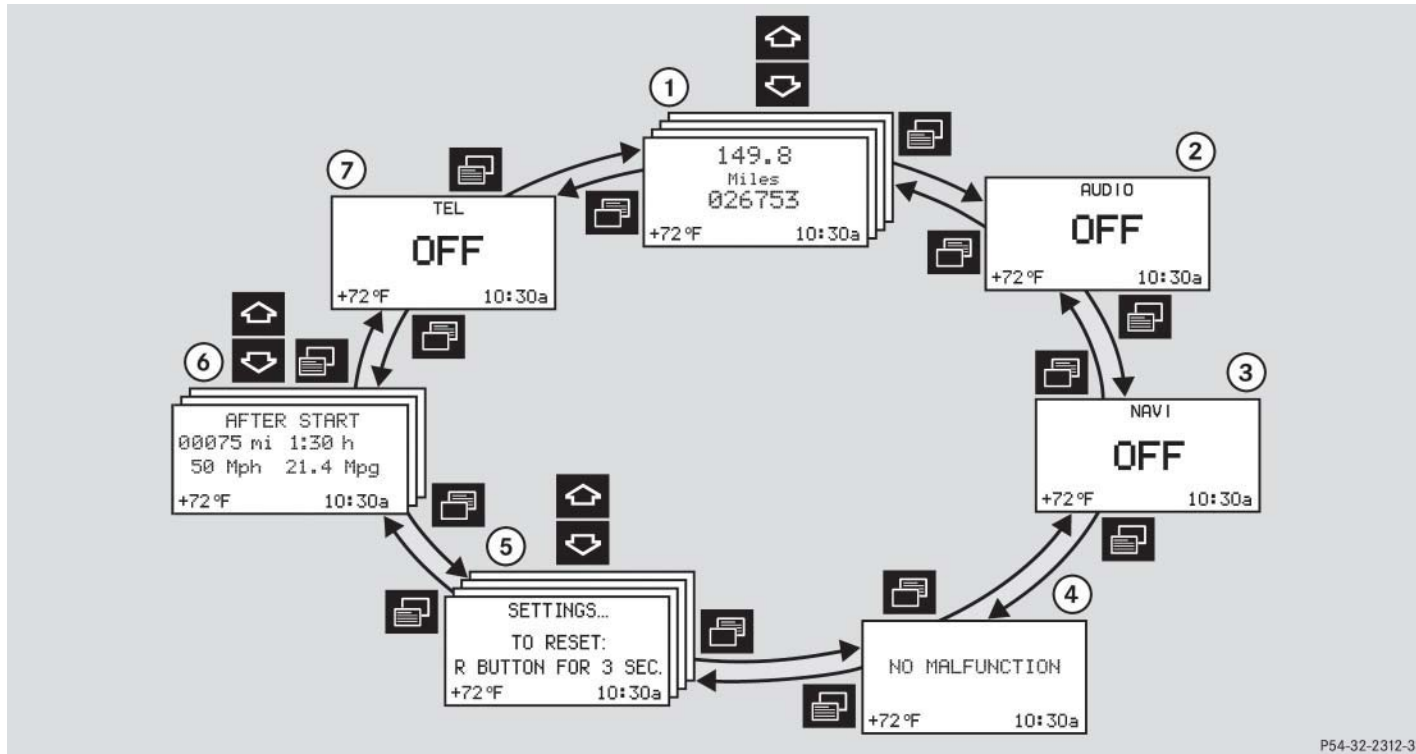

Menus, submenus and functions

	Menu ① Standard display	Menu ② AUDIO	Menu ③ NAVI*	Menu ④ Malfunction memory	Menu ⑤ Settings	Menu ⑥ Trip computer	Menu ⑦ Telephone*
Commands / submenus	Coolant temperature display	Select radio station	Activate route guidance	Call up malfunction messages	Reset to factory settings	Fuel consumption statistics after start	Load phone book
	Digital speedometer	Operate CD player*			Instrument cluster submenu	Fuel consumption statistics since the last reset	Search for name in phone book
	Call up FSS	Operate cassette player			Lighting submenu	Call up range	
	Check engine oil level				Vehicle submenu Convenience submenu		

Controls in detail

Control system



The headings used in the menus table are designed to facilitate navigation within the system and are not necessarily identical to those shown in the control system displays.

The first function displayed in each menu will automatically show you which part of the system you are in.

Standard display menu

You can select the functions in the standard display menu with button or .

The following functions are available:

Function	Page
Call up coolant temperature display	110
Call up digital speedometer	118
Call up FSS	265
Check engine oil level	254

Display digital speedometer

- ▶ Press button twice.

The current vehicle speed is shown in the multifunction display.

AUDIO menu



The functions in the AUDIO menu operate the audio equipment which you currently have turned on.

If no audio equipment is currently turned on, the message AUDIO OFF is shown in the display.

The following functions are available:

Function	Page
Select radio station	119
Select satellite radio station*	119
Operate CD player*	120
Operate cassette player	121

Select radio station

- ▶ Turn on the radio (▷ page 176).
Vehicles with COMAND*:
Refer to separate operating instructions.
- ▶ Press button  or  repeatedly until you see the currently tuned station in the display.



- ① Station frequency
- ② Waveband setting
- ③ Setting for station selection using memory

- ▶ Press button  or  repeatedly until the desired station is found.

The type of search depends on the setting for the station tuning (▷ page 132):

- The next stored station is selected (SP)
- Station search



You can only store new stations using the corresponding feature on the radio (▷ page 181).

Vehicles with COMAND*:
Refer to separate operating instructions.

You can also operate the radio in the usual manner.

Controls in detail

Control system

Select satellite radio station*

The Sirius-Satellite-Radio is treated as a radio application.

- ▶ Select SAT radio with the corresponding softkey in the radio menu.

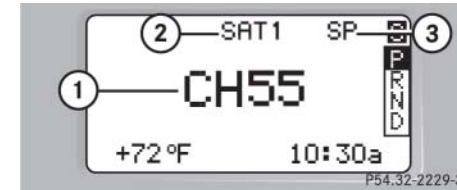

- ① Channel name or number
- ② SAT mode and preset number
- ③ Setting for station selection using memory



Controls in detail

Control system

- ▶▶ Press button  or  repeatedly until the desired channel is found.





Feature description is based on preliminary information available at time of printing.

For more information on satellite radio operation, see “Satellite radio (SAT)* (USA only)” (▷ page 182).

Vehicles with COMAND*:
Refer to separate operating instructions.

Operate the CD player*

- ▶ Turn on the radio and select the CD player (▷ page 189).
Vehicles with COMAND*:
Refer to separate operating instructions.
- ▶ Press button  or  repeatedly until the settings for the CD currently being played are shown in the display.

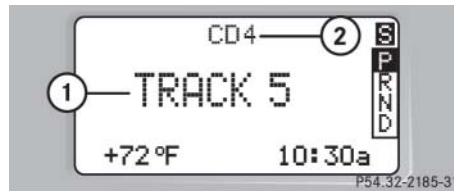



- ① Current track
- ② Current CD (for CD changer*)

- ▶ Press button  or  repeatedly until the desired track is selected.





To select a CD from the magazine, press a number on the audio system or the COMAND* system key pad located in the center dashboard.

Operate the cassette player

- ▶ Turn on the radio and select the cassette player (▷ page 186). Vehicles with COMAND*: Refer to separate operating instructions.
- ▶ Press button  or  repeatedly until the settings for the cassette currently being played are shown in the display.



① Current side



- ▶ Press button  to fast forward to the next track.
- ▶ Press button  to rewind the cassette to the beginning of the current track.



To select the reverse side of the tape, press button below track number on the audio system display, or enter request on the COMAND* system located in the center dashboard.

NAVI* menu

The NAVI menu contains the functions needed to operate your navigation system.

- ▶ Press button  or  repeatedly until you see the message NAVI in the display.
 - If the navigation system is switched off, the message NAVI OFF is shown in the display.
 - If the navigation system is on, the message NAVI ACTIVE is shown in the display.

Please refer to the COMAND* manual for instructions on how to activate the route guidance system*.

Controls in detail

Control system



Malfunction memory menu

Use the malfunction memory menu to scan malfunction and warning messages that may be stored in the system. What information is shown in the display depends on whether malfunctions have actually occurred.

Warning!



Malfunction and warning messages are only indicated for certain systems and are intentionally not very detailed. The malfunction and warning messages are simply a reminder with respect to the operation of certain systems and do not replace the owner's and/or driver's responsibility to maintain the vehicle's operating safety by having all required maintenance and safety checks performed on the vehicle and by bringing the vehicle to an authorized Mercedes-Benz Center to address the malfunction and warning messages (▷ page 280).

- ▶ Press button  or  repeatedly until you see the malfunction message memory in the display.

No malfunction messages



If no malfunctions have occurred, the message in the display is:
NO MALFUNCTION

Malfunctions have occurred

If malfunctions have occurred, you will see the number of malfunctions in the display:



- ① Number of malfunctions

- ▶ Press button  or .

The stored messages will now be displayed in order. For malfunction and warning messages, see “Messages in the display” (▷ page 280).



Should any malfunctions occur while driving, the number of malfunctions will reappear in the display when the SmartKey in the starter switch is turned to position **0** or removed from the starter switch.



The message memory will be cleared when you turn the SmartKey in the starter switch to position **1** or **2**. You will then only see high-priority messages in the multifunction display (▷ page 280).

Settings menu

In the SETTINGS menu there are two functions:

- The function RESET TO FACTORY SETTINGS, with which you can reset all the settings to the original factory settings.
 - A collection of submenus with which you can make individual settings for your vehicle.
- ▶ Press button  or  repeatedly until the SETTINGS menu is seen in the display.



Resetting all settings

You can reset all the functions of all submenus to the factory settings.

- ▶ Press the reset button in the instrument cluster (▷ page 22) for approximately three seconds.

In the display you will see the request to press the reset button again to confirm.



- ▶ Press the reset button again.

The functions of all the submenus will reset to factory settings.



The settings you have changed will not be reset unless you confirm the action by pressing the reset button a second time. Approximately five seconds after pressing the reset button for the second time, the SETTINGS... menu reappears in the display.



For safety reasons, the following functions are not reset while driving:

- the LIGHT CIRCUIT HEADLIGHT MODE function in the LIGHTING submenu
- the SETTINGS KEY-DEPENDENT function in the CONVENIENCE submenu

Controls in detail

Control system

Submenus in the Settings menu



- ▶ Press button  or .



In the display you see the collection of the submenus.





- ▶ Press button .

The selection marker moves to the next submenu.

The submenus are arranged by hierarchy. Scroll down with the  button, scroll up with the  button.

Move within the submenus with the  or  button to the individual functions.

The settings themselves are made with button  or .

Resetting the functions of a submenu

For each submenu you can reset all the functions to the factory settings.

- ▶ Move to a function in the submenu.
- ▶ Press the reset button (> page 22) in the instrument cluster for approximately three seconds.

In the display you will see the request to press the reset button again to confirm.

- ▶ Press the reset button again.

All functions of the submenu will reset to factory settings.



The settings you have changed will not be reset unless you confirm the action by pressing the reset button a second time. Approximately five seconds after pressing the reset button for the second time, the SETTINGS... menu reappears in the display.

The table below shows what settings can be changed within the various menus. Detailed instructions on making individual settings can be found on the following pages.

INSTRUMENT CLUSTER	LIGHTING	VEHICLE	CONVENIENCE
Set time (hours)	Set daytime running lamp mode (USA only)	Set station selection mode (radio)	Activate easy-entry/exit feature
Set time (minutes)	Set locator lighting	Set automatic locking	Set key-dependency
Select time display mode	Exterior lamps delayed shut-off		Set parking position for exterior rear view mirror
Select temperature display mode	Interior lighting delayed shut-off		
Select speedometer display mode			
Select language			
Select display (speed display or outside temperature)			

Controls in detail

Control system

Instrument cluster submenu

Access the INSTRUMENT CLUSTER submenu via the SETTINGS menu. Use the INSTRUMENT CLUSTER submenu to change the instrument cluster display settings. The following functions are available:

Function	Page
Set time (hours)	126
Set time (minutes)	126
Select time display mode	127
Select temperature display mode	127
Select speedometer display mode	128
Select language	128
Select display (speed display or outside temperature)	129

Set time (hours)

This function can only be seen with audio system.



Vehicles with COMAND*:
For information on setting the time, refer to the separate COMAND operating instructions.

- ▶ Move the selection marker with the **+** or **-** button to the INSTRUMENT CLUSTER submenu.
- ▶ Press button or repeatedly until you see this message in the display: TIME SETTINGS - HOURS.

The selection marker is on the hour setting.



- ▶ Press **+** or **-** to set the hour.

Set time (minutes)

This function can only be seen with audio system.



Vehicles with COMAND*:
For information on setting the time, refer to the separate COMAND operating instructions.

- ▶ Move the selection marker with the **+** or **-** button to the INSTRUMENT CLUSTER submenu.

Controls in detail

Control system





- ▶ Press button  or  repeatedly until you see this message in the display: TIME SETTINGS - MINUTES.

The selection marker is on the minute setting.





- ▶ Press  or  to set the minutes.

Selecting time display mode



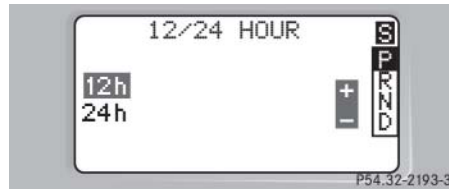

- ▶ Move the selection marker with the  or  button to the INSTRUMENT CLUSTER submenu.
- ▶ Press button  or  repeatedly until you see this message in the display: 12/24 HOUR.

The selection marker is on the current setting.





- ▶ Press  or  to set the 12h or 24h time display mode.

Selecting temperature display mode

- ▶ Move the selection marker with the  or  button to the INSTRUMENT CLUSTER submenu.
- ▶ Press button  or  repeatedly until you see this message in the display: TEMP. INDICATOR.

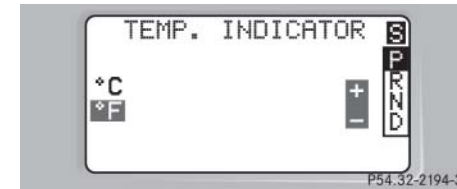
The selection marker is on the current setting.



- ▶ Press  or  to set temperature unit to degrees Celsius (°C) or degrees Fahrenheit (°F).

Controls in detail

Control system

Selecting speedometer display mode

- ▶ Move the selection marker with the **+** or **-** button to the INSTRUMENT CLUSTER submenu.
- ▶ Press button **▲** or **▼** repeatedly until you see this message in the display: DISPLAY VALUES IN.

The selection marker is on the current setting.



- ▶ Press **+** or **-** to set speedometer unit to Km or Miles.

Selecting language

- ▶ Move the selection marker with the **+** or **-** button to the INSTRUMENT CLUSTER submenu.
- ▶ Press button **▲** or **▼** repeatedly until you see this message in the display: TEXT.

The selection marker is on the current setting.



- ▶ Press **+** or **-** to select the language to be used for the multifunction display messages.

Available languages:

- German
- English
- French
- Italian
- Spanish

Selecting display (speed display or outside temperature)

- ▶ Move the selection marker with the **+** or **-** button to the INSTRUMENT CLUSTER submenu.
- ▶ Press button **▲** or **▼** repeatedly until you see this message in the display: SELECT DISPLAY.

The selection marker is on the current setting.

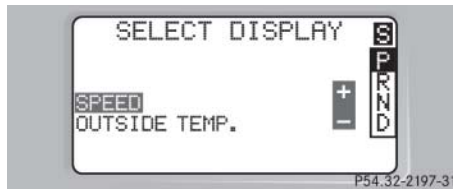

- ▶ Press **+** or **-** to select the display permanently shown in the multifunction display.

Lighting submenu

Access the LIGHTING submenu via the SETTINGS menu. Use the LIGHTING submenu to change the lamp and lighting settings on your vehicle. The following functions are available:

Function	Page
Set daytime running lamp mode (USA only)	129
Set locator lighting	130
Exterior lamps delayed shut-off	131
Interior lighting delayed shut-off	132

Setting daytime running lamp mode (USA only)

- ▶ Move the selection marker with the **+** or **-** button to the LIGHTING submenu.
- ▶ Press button **▲** or **▼** repeatedly until you see this message in the display: LIGHT CIRCUIT HEADLIGHT MODE.

The selection marker is on the current setting.



- ▶ Press **+** or **-** to select manual or daytime running lamp (constant) mode. This function is not available in countries where daytime running lamps are mandatory.

▷▷

Controls in detail

Control system

- ▷▷ With daytime running lamp mode selected and the exterior lamp switch at position **0**, the following lamps will come on automatically when the engine is turned on:
- Parking lamps and low beam headlamps
 - License plate lamps (in low ambient light conditions)



If you turn the exterior lamp switch to another position, the corresponding lamp(s) will switch on.

For safety reasons, resetting the LIGHTING submenu to factory settings (▷ page 124) while driving will not reset the daytime running lamp mode.

In the display you will then see the message: LIGHTING - CANNOT BE TOTALLY RESET TO FACTORY SETTINGS WHILE DRIVING!.

Setting locator lighting

During darkness, the following lamps will come on when the exterior lamp switch is in position **AUTO**, the locator lighting feature is activated, and the vehicle is unlocked by SmartKey:

- Parking lamps
- Tail lamps
- License plate lamps
- Front fog lamps

To activate locator lighting:

- ▶ Make sure the function LOCATOR LIGHTING is set.
- ▶ Turn the exterior lamp switch to position **AUTO**.

The locator lighting switches off when the driver's door is opened. It switches off automatically after a period of approximately 40 seconds.

- ▶ Move the selection marker with the **+** or **-** button to the LIGHTING submenu.
- ▶ Press button or repeatedly until you see this message in the display: LOCATOR LIGHTING.

The selection marker is on the current setting.

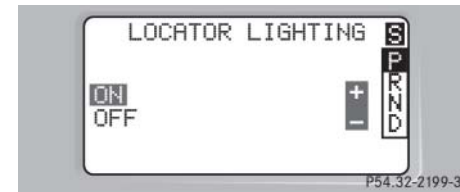

- ▶ Press **+** or **-** to select the desired setting.

The locator lighting will be switched on or off.

Setting night security illumination

(Exterior lamps delayed shut-off)

Use the HEADLIGHTS DELAYED SHUT-OFF function to set whether and for how long you would like the exterior lamps to illuminate during darkness after all doors are closed.

When the delayed shut-off feature is activated and the exterior lamp switch is in position **AUTO**, the following lamps will remain lit after you remove the SmartKey from the starter switch:

- Parking lamps
- Tail lamps
- License plate lamps
- Front fog lamps



You can reactivate this function within ten minutes by opening a door.

If you do not open a door after removing the SmartKey, the lamps will automatically switch off after 60 seconds.

To activate night security illumination:

- ▶ Select delayed shut-off period (▷ page 131).
- ▶ Turn the exterior lamp switch to position **AUTO**.

To select delayed shut-off period:

- ▶ Move the selection marker with the **+** or **-** button to the LIGHTING submenu.
- ▶ Press button or repeatedly until you see this message in the display: HEADLIGHTS DELAYED SHUT-OFF.

Controls in detail

Control system

The selection marker is on the current setting.



- ▶ Press **+** or **-** to select the desired lamp-on period.

You can select:

- 0 s, the delayed shut-off feature is deactivated
- 15 s, 30 s, 45 s or 60 s, the delayed shut-off feature is activated

You can temporarily deactivate the delayed shut-off feature:

- ▶ Before leaving the vehicle turn the SmartKey in the starter switch to position **0**.
- ▶ Then turn it to position **2** and back to **0**.



Controls in detail

Control system

- ▷▷ The delayed shut-off feature is deactivated. It will reactivate as soon as you reinsert the SmartKey in the starter switch.

Interior lighting delayed shut-off

Use this function to set whether and for how long you would like the interior lighting to remain lit during darkness after the SmartKey is removed from the starter switch.

- ▶ Move the selection marker with the **+** or **-** button to the LIGHTING submenu.
- ▶ Press button **▲** or **▼** repeatedly until you see this message in the display: INT. LIGHTING DELAYED SHUT-OFF.

The selection marker is on the current setting.

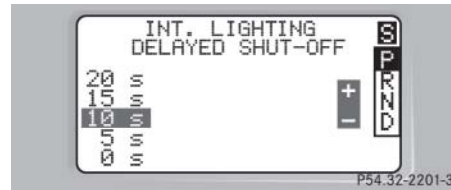

- ▶ Press **+** or **-** to select the desired lamp-on time period.

You can select:

- 0 s, the delayed shut-off feature is deactivated
- 5 s, 10 s, 15 s or 20 s, the delayed shut-off feature is activated

Vehicle submenu



Access the VEHICLE submenu via the SETTINGS menu. Use the VEHICLE submenu to make general vehicle settings. The following functions are available:

Function	Page
Set station selection mode (radio)	132
Set automatic locking	133



Setting station selection mode

Use the PRESS BUTTON IN AUDIO MODE function to select the manual or memory station selection mode for the radio (▷ page 119).

- ▶ Move the selection marker with the **+** or **-** button to the VEHICLE submenu.

- ▶ Press button  or  repeatedly until you see this message in the display: PRESS BUTTON IN AUDIO MODE. The selection marker is on the current setting.







- ▶ Press  or  to select the desired station selection mode.

You can select:

- STATION SEARCH
- MEMORY selects next stored station

Setting automatic locking

Use this function to activate or deactivate the automatic central locking. With the automatic central locking system activated, the vehicle is centrally locked at vehicle speeds of approximately 9 mph (15 km/h).

- ▶ Move the selection marker with the  or  button to the VEHICLE submenu.
- ▶ Press button  or  repeatedly until you see this message in the display: AUTOMATIC DOOR LOCK.

The selection marker is on the current setting.



- ▶ Press  or  to switch AUTOMATIC DOOR LOCK ON or OFF.

Convenience submenu

Access the CONVENIENCE submenu via the SETTINGS menu. Use the CONVENIENCE submenu to change the settings for a number of convenience features. The following functions are available:

Function	Page
Activate easy-entry/exit feature*	134
Set key-dependency	135
Set parking position for exterior rear view mirror	136

Controls in detail

Control system

Activating easy-entry/exit feature*

Use this function to activate and deactivate the easy-entry/exit feature. When the feature is activated, the steering wheel and driver's seat will move back to facilitate exiting when you

- remove the SmartKey from the starter switch
- open the driver's door

However, the engine must be turned off.

Warning!



You must make sure no one can become trapped or injured by the moving steering wheel and the driver's seat when the easy-entry/exit feature* is activated and the driver's door is being opened and the engine is turned off or the SmartKey is removed from the starter switch.

Do not leave children unattended in the vehicle, or with access to an unlocked vehicle. Children could open the driver's door and unintentionally activate the easy-entry/exit feature*, which could result in an accident and/or serious personal injury.

After entering the vehicle the steering wheel and seat will move into the position stored in memory when you

- close the driver's door with the SmartKey in starter switch position **2**.
- you put the SmartKey in the starter switch with the driver's door closed.



To cancel seat/steering wheel movement, do one of the following:

- press the seat adjustment switch* (▷ page 35)
- move the steering column stalk* (▷ page 37)
- press the stored position button* (▷ page 100)

- ▶ Move the selection marker with the **+** or **-** button to the CONVENIENCE submenu.
- ▶ Press button **▲** or **▼** repeatedly until you see this message in the display: EASY-ENTRY FEATURE ACTIVATE.

The selection marker is on the current setting.

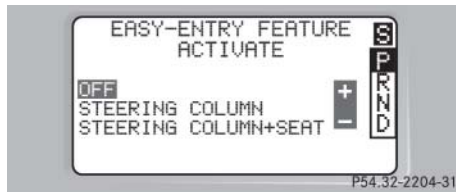

- ▶ Press **+** or **-** to change the easy-entry/exit setting.

The following settings are available for the easy-entry/exit feature:

OFF	The easy-entry/exit feature is deactivated
STEERING COLUMN	Only the steering column is moved
STEERING COLUMN + SEAT	Both the steering column and the seat are moved

Setting key-dependency

Use this function to set whether the memory settings for the seats, the steering wheel and the mirrors should be stored separately for each SmartKey (▷ page 99).

- ▶ Move the selection marker with the **+** or **-** button to the CONVENIENCE submenu.
- ▶ Press button **▲** or **▼** repeatedly until you see this message in the display: SETTINGS KEY-DEPENDENT.

The selection marker is on the current setting.



- ▶ Press **+** or **-** to set key-dependency to ON or OFF.

Controls in detail

Control system

Controls in detail

Control system

Setting parking position* for exterior rear view mirror

Use the MIRROR SETTING WHEN PARKING function to select whether the passenger-side exterior rear view mirror should be turned downward during parking maneuvers when reverse gear **R** is engaged. For additional information, see “Activating exterior rear view mirror parking position*” (▷ page 150).

- ▶ Move the selection marker to the CONVENIENCE submenu using the **+** or **-** button.

- ▶ Press button **▲** or **▼** repeatedly until you see this message in the display: MIRROR SETTING WHEN PARKING.

The selection marker is on the current setting.



- ▶ Press **+** or **-** to switch function ON or OFF.

Trip computer menu





Use the trip computer menu to call up statistical data on your vehicle. The following information is available:

Function	Page
Fuel consumption statistics after start	137
Fuel consumption statistics since last reset	137
Call up range (distance to empty)	138

Controls in detail

Control system





Fuel consumption statistics after start

- ▶ Press button  or  repeatedly until you see the first function of the Trip computer menu.
- ▶ Press button  or  repeatedly until you see this message in the display: AFTER START.



- ① Distance driven since start
- ② Time elapsed since start
- ③ Average fuel consumption since start
- ④ Average speed since start

Fuel consumption since last reset

- ▶ Press button  or  repeatedly until you see the first function of the Trip computer menu.
- ▶ Press button  or  repeatedly until you see this message in the display: AFTER RESET.







- ① Distance driven since last reset
- ② Time elapsed since last reset
- ③ Average fuel consumption since last reset
- ④ Average speed since last reset

i

All statistics stored since the last engine start will be reset approximately four hours after the SmartKey in the starter switch is turned to position 0 or removed from the starter switch.

Resetting will not occur if you turn the SmartKey back to position 1 or 2 within this time period.





Resetting fuel consumption statistics

- ▶ Press button  or  repeatedly until you see the first function of the Trip computer menu.
- ▶ Press button  or  repeatedly until you see the reading that you want to reset in the display.
- ▶ Press and hold the reset button in the instrument cluster (> page 22) until the value is reset to 0.

Controls in detail

Control system

Call up range (distance to empty)

- ▶ Press button  or  repeatedly until you see the first function of the Trip computer menu.
- ▶ Press button  or  repeatedly until you see this message in the display: RANGE.

In the display you will see the calculated range based on the current fuel tank level.



TEL menu*

Warning!





A driver's attention to the road must always be his/her primary focus when driving. For your safety and the safety of others, we recommend that you pull over to a safe location and stop before placing or taking a telephone call. If you choose to use the telephone while driving, please use the hands-free device and only use the telephone when weather, road and traffic conditions permit.

Some jurisdictions prohibit the driver from using a cellular telephone while driving a vehicle.

Bear in mind that at a speed of just 30 mph (approximately 50 km/h), your vehicle is covering a distance of approximately 44 feet (approximately 13.5 m) every second.

Never operate radio transmitters equipped with a built-in or attached antenna (i.e. without being connected to an external antenna) from inside the vehicle while the engine is running. Doing so could lead to a malfunction of the vehicle's electronic system, possibly resulting in an accident and personal injury.

You can use the functions in the TEL menu to operate your telephone, provided it is connected to a hands-free system and switched on.

- ▶ Switch on the telephone and COMAND*.
- ▶ Press button  or  on the steering wheel repeatedly until you see the TEL menu in the display.

Controls in detail

Control system

Which messages will appear in the display field depends on whether your telephone is switched on or off:

- If the telephone is off, the message in the multifunction display is: TEL OFF.
- If the telephone is on:

The telephone will then search for a network. During this time the display is empty.

As soon as the telephone has found a network, READY is indicated in the display.



① Signal strength

This standby message indicates that your telephone is ready for use and you can operate it using the control system.



Vehicles with Audio system:

The signal strength is indicated in the top right corner, for example "S9". The higher the number, the stronger the signal from the cellular network.

Vehicles with COMAND*:

The signal strength is indicated by bars in the top left corner. The higher the number of bars, the stronger the signal from the cellular network.

Answering a call

When your telephone is ready to receive calls, you can answer a call at any time. In the display you will then see the message:

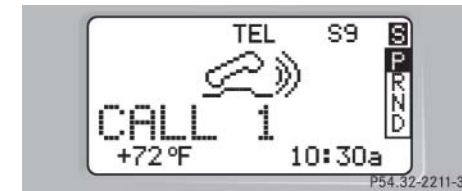

- ▶ Press button .

You have answered the call. In the display you see the length of the call.

Ending a call

- ▶ Press button .





You have ended the call. In the display you will again see the standby message.

Controls in detail

Control system



Dialing a number from the phone book

If your telephone is ready to receive calls, you may select and dial a number from the phone book at any time.

- ▶ Press button  or  repeatedly until you see the TEL menu in the display.
- ▶ Press button  or .



The control system reads the phone book which is stored in the telephone. This may take up to 30 seconds. In the display you will see the message PLEASE WAIT.

When the message PLEASE WAIT disappears, the phone book has been loaded.

- ▶ Press button  or  repeatedly until the desired name appears in the display.

The stored names are displayed in ascending or descending alphabetical order.



If you press and hold  or  for longer than one second, the system scrolls rapidly through the list of names until you release the button again.

Cancel the quick search mode by pressing .

- ▶ Press button .

The system dials the selected phone number.



- If the connection is successful, the name of the party you called and the duration of the call will appear in the display.



- If no connection is made, the control system stores the dialed number in the redial memory.



Redialing

The control system stores the most recently dialed phone numbers. This eliminates the need to search through your entire phone book.

- ▶ Press button  or  repeatedly until you see the TEL menu in the display.

- ▶ Press button .

In the display you see the first number in the redial memory.

- ▶ Press button  or  repeatedly until the desired name appears in the display.

- ▶ Press button .

The control system dials the selected phone number.

▼ Manual transmission

Manual transmission is standard equipment on select models and not available on all models.

For information on driving with a manual transmission, see “Manual transmission” (▷ page 43).

Do not exceed the maximum speed in the individual gears. Refer to tachometer (▷ page 111) for engine speeds.

Warning!



For vehicles equipped with a manual transmission, getting out of your vehicle with the gearshift lever not engaged in first or reverse gear and parking brake engaged is dangerous.

Also, when parked on an incline, an engaged first or reverse gear alone may not prevent your vehicle from moving, possibly hitting people or objects.

Always set the parking brake in addition to engaging first or reverse gear (▷ page 50).

When parked on an incline, turn front wheels towards the road curb.

Do not park this vehicle in areas where combustible materials such as grass, hay or leaves can come into contact with the hot exhaust system, as these materials could be ignited and cause a vehicle fire.

Warning!



When leaving the vehicle, always remove the SmartKey from the starter switch, take it with you and lock the vehicle. Do not leave children unattended in the vehicle, or with access to an unlocked vehicle. Children could move the gearshift lever, which could result in an accident and/or serious injury.

Warning!



On slippery road surfaces, never downshift in order to obtain braking action.

Controls in detail

Manual transmission

This could result in drive wheel slip and reduced vehicle control. Your vehicle's ABS will not prevent this type of loss of control.



Downshifting gears leading to overrevving the engine can result in engine damage that is not covered by the Mercedes-Benz Limited Warranty.

Never hold the vehicle stopped on a hill by using the clutch pedal. The clutch may be damaged which is not covered by the Mercedes-Benz Limited Warranty.

Do not exceed the engine speed limits (▷ page 111).

Shifting into reverse

- ▶ Stop the vehicle completely.
- ▶ Pull gearshift lever up and shift in **R** reverse.

Controls in detail

Automatic transmission*

▼ Automatic transmission*

Automatic transmission is standard equipment on select models and available as optional equipment on other models

Information on driving with an automatic transmission is found in the “Getting started” section (▷ page 44).

Your vehicle’s transmission adapts its gear shifting process to your individual driving style by continually adjusting the shift points up or down. These shift point adjustments are performed based on current operating and driving conditions.

If the operating conditions change, the automatic transmission reacts by adjusting its gear shift program.



During the brief warm-up, transmission upshifting is delayed. This allows the catalytic converter to heat up more quickly to operating temperature.

The automatic transmission selects individual gears automatically, depending on:

- the gear selector lever position **D** with gear ranges **4, 3, 2, 1** (▷ page 144)
- the selected shift program (**C/S**) (▷ page 146)
- the position of the accelerator pedal (▷ page 147)
- the vehicle speed

The current gear selector lever position and shift program (C/S) appear in the multifunction display (▷ page 113).

An additional indication of the current gear selector lever position can be found on the cover of the shifting-gate. The indicators come on when you activate a switch (e.g. unlocking the vehicle or opening a door) and go out after approximately 15 minutes.

Warning!



It is dangerous to shift the gear selector lever out of **P** or **N** if the engine speed is higher than idle speed. If your foot is not firmly on the brake pedal, the vehicle could accelerate quickly forward or reverse. You could lose control of the vehicle and hit someone or something. Only shift into gear when the engine is idling normally and when your right foot is firmly on the brake pedal.

When the gear selector lever is in position **D**, you can influence transmission shifting by:

- limiting the gear range
- changing gears manually

One-touch gearshifting

Even with an automatic transmission you can change the gears manually when the gear selector lever is in position **D**.

Downshifting

- ▶ Briefly press the gear selector lever to the left in the **D-** direction.

The transmission will shift from the current gear to the next lower gear. This action simultaneously limits the gear range of the transmission (> page 144).

Warning!



On slippery road surfaces, never downshift in order to obtain braking action. This could result in drive wheel slip and reduced vehicle control. Your vehicle's ABS will not prevent this type of loss of control.



To avoid overrevving the engine when the gear selector lever is moved to the **D-** direction, the transmission will not shift to a lower gear if the engine's max. speed would be exceeded.

Upshifting

- ▶ Briefly press the gear selector lever to the right in the **D+** direction.

The transmission will shift from the current gear to the next higher gear as permitted by the shift program. This action simultaneously extends the gear range of the transmission.

Controls in detail

Automatic transmission*

Canceling gear range limit

- ▶ Press and hold the gear selector lever in the **D+** direction until **D** reappears in the multifunction display.

The transmission will shift from the current gear range directly to gear range **D**.

Shifting into optimal gear range

- ▶ Press and hold the gear selector lever in the **D-** direction.

The transmission will automatically select the gear range suited for optimal acceleration and deceleration. This will involve shifting down one or more gears.

Controls in detail

Automatic transmission*

Gear ranges

With the gear selector lever in position **D**, you can limit the transmission's gear range by pressing the gear selector lever to the left (**D-**), and reverse the gear range limit by pressing the gear selector lever to the right (**D+**).

The selected gear range appears in the multifunction display. If you press on the accelerator when the engine has reached its rpm limit, the transmission will upshift beyond any gear range limit selected.

	Effect
4	The transmission shifts through fourth gear only.
3	The transmission shifts through third gear only. With this selection you can use the braking effect of the engine.

	Effect
2	The transmission shifts through second gear only. Allows the use of engine's braking power when driving: <ul style="list-style-type: none">• on steep downgrades• in mountainous regions• under extreme operating conditions
1	The transmission operates in first gear only. For maximum use of engine's braking effect on very steep or lengthy downgrades.

Controls in detail

Automatic transmission*

Gear selector lever position

	Effect
P	Park position Gear selector lever position when the vehicle is parked. Place gear selector lever in position P only when vehicle is stopped. The park position is not intended to serve as a brake when the vehicle is parked. Rather, the driver should always set the parking brake in addition to placing the gear selector lever in position P to secure the vehicle.

	Effect
	The SmartKey can only be removed from the starter switch with the gear selector lever in position P . With the SmartKey removed, the gear selector lever is locked in position P . If the vehicle's electrical system is malfunctioning, the gear selector lever could remain locked in position P (▷ page 308).
R	Reverse gear Place gear selector lever in position R only when vehicle is stopped.

	Effect
N	Neutral No power is transmitted from the engine to the drive axle. When the brakes are released, the vehicle can be moved freely (pushed or towed). To avoid damage to the transmission, never engage N while driving. If the ESP is deactivated or malfunctioning: Move gear selector lever to N only if the vehicle is in danger of skidding, e.g. on icy roads.
D	Drive The transmission shifts automatically. All five forward gears are available.

Controls in detail

Automatic transmission*



Coasting the vehicle, or driving for any other reason with gear selector lever in **N** can result in transmission damage that is not covered by the Mercedes-Benz Limited Warranty.

Warning!



Getting out of your vehicle with the gear selector lever not fully engaged in position **P** is dangerous. Also, position **P** alone is not intended to or capable of preventing your vehicle from moving, possibly hitting people or objects.

Always set the parking brake in addition to shifting to position **P** (▷ page 50).

When parked on an incline, turn the front wheels towards the road curb.

Do not park this vehicle in areas where combustible materials such as grass, hay or leaves can come into contact with the hot exhaust system, as these materials could be ignited and cause a vehicle fire.

Warning!



When leaving the vehicle, always remove the SmartKey from the starter switch, take it with you and lock the vehicle. Do not leave children unattended in the vehicle, or with access to an unlocked vehicle. Children could move the gear selector lever from position **P**, which could result in an accident and/or serious personal injury.

Program mode selector switch

The program mode selector switch is located on the lower part of the center console.



① Program mode selector switch

S Sport For standard driving

C Comfort For comfort driving



Never change the program mode when the gear selector lever is out of position **P**. This could result in a change of driving characteristics for which you may not be prepared.

- ▶ Press program mode selector switch ① repeatedly until the letter of the desired shift program appears in the multifunction display (▷ page 113).

Select **C** for comfort driving:

- The vehicle starts out in second gear (both forward and reverse) for gentler starts. This does not apply if full throttle is applied or gear range **1** is selected.
- Traction and driving stability are improved on icy roads.
- Upshifts occur earlier even when you give more gas. The engine then operates at lower rpms and the wheels are less likely to spin.
- The power transmission ratio for gear selector lever position **R** changes depending on the program mode selected (**S** or **C**).

Accelerator position

Your driving style influences the transmission's shifting behavior:

Less throttle Earlier upshifting
More throttle Later upshifting

Kickdown

Use kickdown when you want maximum acceleration.

- ▶ Press the accelerator past the point of resistance.
The transmission shifts into a lower gear.
- ▶ Ease on the accelerator when you have reached the desired speed.
The transmission shifts up again.

Emergency operation (Limp Home Mode)

If vehicle acceleration worsens or the transmission no longer shifts, the transmission is most likely operating in limp home (emergency operation) mode. In this mode only second gear and reverse gear can be activated.

- ▶ Stop the vehicle.
- ▶ Move gear selector lever to **P**.
- ▶ Turn off the engine.
- ▶ Wait at least ten seconds before restarting.
- ▶ Restart the engine.
- ▶ Move gear selector lever to position **D** (for second gear) or **R**.
- ▶ Have the transmission checked at an authorized Mercedes-Benz Center as soon as possible.

Controls in detail

Good visibility

▼ Good visibility

Windshield wipers

More information on the windshield wipers can be found in the “Getting started” section (▷ page 47).

Intermittent wiping



Intermittent wiping is interrupted when the vehicle is at a standstill and a front door is opened.

Windshield wipers with rain sensor*

A rain sensor automatically controls the windshield wipers depending on how wet the windshield is.

- ▶ Switch on ignition.
- ▶ Set the wiper switch to position I (▷ page 48).

After the initial wipe, pauses between wipes are automatically controlled by the rain sensor.



Do not leave windshield wipers in intermittent setting when the vehicle is taken to an automatic car wash or during windshield cleaning. Wipers will operate in the presence of water sprayed on the windshield, and wipers may be damaged as a result.

The switch should not be left in intermittent setting as the wipers will wipe the windshield once every time the engine is started. Dust that accumulates on the windshield might scratch the glass and/or damage the wiper blades when wiping occurs on a dry windshield.

Headlamp cleaning system*

The switch is located on the left side of the dashboard.



① Headlamp washer switch

- ▶ Switch on ignition.
- ▶ Press switch ①.

The headlamps are cleaned with a high-pressure water jet.

For information on filling up the washer reservoir, see “Windshield washer system and headlamp cleaning system*” (▷ page 259).

Rear view mirrors

More information for setting the rear view mirrors can be found in the “Getting started” section (► page 38).

Interior rear view mirror, antiglare position

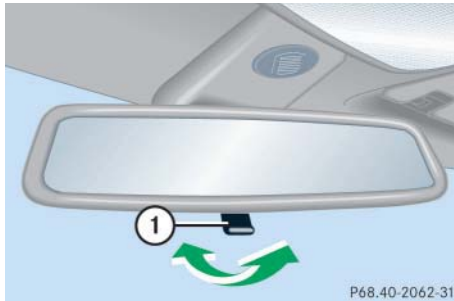

P68.40-2062-31

① Lever

- Tilt the mirror to the antiglare night position by moving lever ① towards the windshield.

Automatic antiglare rear view mirrors*

The reflection brightness of the exterior rear view mirror on the driver's side and the interior rear view mirror will respond automatically to glare when

- the ignition is switched on and
- incoming light from headlamps falls on the sensor in the interior rear view mirror.

The rear view mirror will not react if

- reverse gear is engaged
- the interior lighting is turned on

Warning!



The automatic antiglare function does not react if incoming light is not aimed directly at sensors in the interior rear view mirror.

The interior rear view mirror and the exterior rear view mirror on the driver's side do not react, for example, if the rear window sunshade* is in raised position.

Glare can endanger you and others.

Controls in detail

Good visibility

Warning!



In the case of an accident liquid electrolyte may escape from the mirror housing if the mirror glass breaks.

Electrolyte has an irritating effect. Do not allow the liquid to come into contact with eyes, skin, clothing, or respiratory system. In case it does, immediately flush affected area with water, and seek medical help if necessary.

Warning!



Exercise care when using the passenger-side exterior rear view mirror. The mirror surface is convex (outwardly curved surface for a wider field of view). Objects in mirror are closer than they appear. Check your interior rear view mirror or glance over your shoulder before changing lanes.



Electrolyte drops coming into contact with the vehicle paint finish can be completely removed only while in the liquid state by applying plenty of water.

Activating exterior rear view mirror parking position*

Follow these steps to activate the mirror parking position so that the passenger-side exterior rear view mirror will be turned downward to the stored position.

- ▶ Make sure you have stored a parking position for the passenger-side exterior rear view mirror (▷ page 101).
- ▶ Make sure the MIRROR SETTING WHEN PARKING function in the CONVENIENCE submenu of the control system is switched to ON (▷ page 136).
- ▶ Switch on ignition (if not already on).

- ▶ Press button ② for the passenger-side exterior rear view mirror.
- ▶ Place the gear selector lever in reverse gear **R**.

The passenger-side exterior rear view mirror will be turned downward to the stored position.

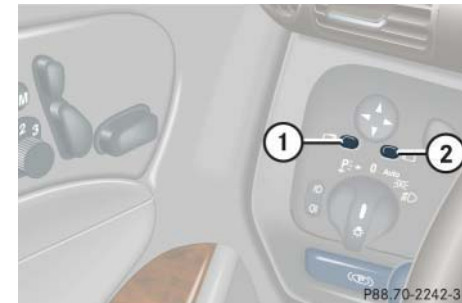

- ① Driver's side exterior rear view mirror button
- ② Passenger-side exterior rear view mirror button

The exterior rear view mirror returns to its previously stored driving position:

- ten seconds after you put the gear selector lever out of position **R**
- immediately once your vehicle exceeds a speed of approximately 6 mph (10 km/h)
- immediately when you press button ① for driver's side mirror

Sun visors

The sun visors protect you from sun glare while driving.

Warning!



Do not use the vanity mirror while driving.

Keep the mirrors in the sun visors closed while vehicle is in motion. Reflected glare can endanger you and others.

- ▶ Swing sun visors down when you experience glare.

Controls in detail

Good visibility

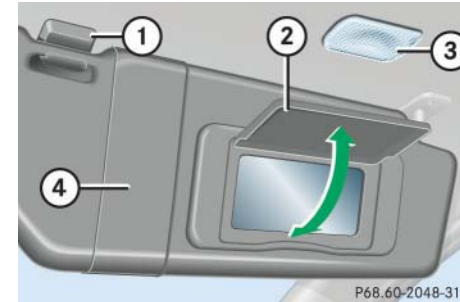

- ① Mounting
- ② Mirror cover
- ③ Mirror lamp
- ④ Sun visor

- ▶ To use illuminated mirror, lift up cover ②.

i

If sunlight enters through a side window, disengage sun visor from mounting ① and pivot to the side.

The mirror lamp ③ will switch off.

Controls in detail

Good visibility

Rear window sunshade*

The switch is located in the center console.



- ▶ Turn the SmartKey to starter switch position **1** or **2**.
- ▶ Press upper switch position ① briefly to raise the sunshade.
- ▶ Press lower switch position ② briefly to lower the sunshade.

Always raise the sunshade fully for its support against the window frame.

Warning!



When operating the rear window sunshade, make sure there is no danger of anyone being harmed by the raising or lowering procedure.

The raising or lowering procedure can be immediately halted by briefly pressing the upper or lower half of the switch.

Briefly press upper or lower half of the switch again to raise or lower the rear window sunshade completely.

Warning!





When leaving the vehicle, always remove the SmartKey from starter switch, and lock your vehicle. Do not leave children unattended in the vehicle, or with access to an unlocked vehicle. Unsupervised use of vehicle equipment can cause an accident and/or serious personal injury.

Rear window defroster

The rear window defroster uses a large amount of power. To keep the battery drain to a minimum, switch off the defroster as soon as the rear window is clear. The defroster is automatically deactivated after approximately 6 to 17 minutes of operation depending on the outside temperature.

Activating

- ▶ Climate control:
Press button  (▷ page 155).
 - Automatic climate control*:
Press button  (▷ page 163).
- The indicator lamp on the button comes on.

Deactivating

- ▶ Press button  again.
The indicator lamp on the button goes out.

Warning!



Any accumulation of snow and ice should be removed from the rear window before driving. Visibility could otherwise be impaired, endangering you and others.

Controls in detail

Good visibility



If the rear window defroster switches off too soon and the indicator lamp starts flashing, this means that too many electrical consumers are operating simultaneously and there is insufficient voltage in the battery. The system responds automatically by deactivating the rear window defroster.

As soon as the battery has sufficient voltage, the rear window defroster automatically turns itself back on.

Controls in detail

Climate control

▼ Climate control

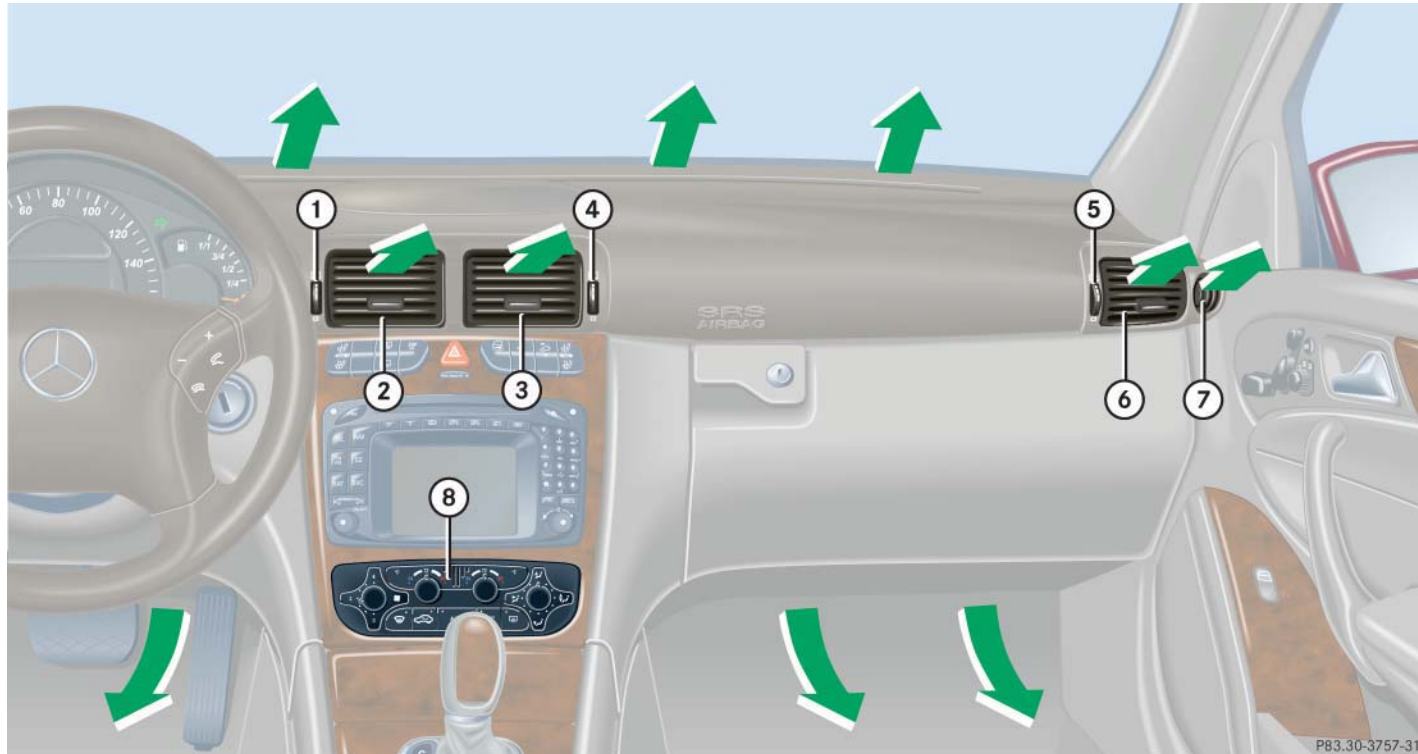

Item
① Thumbwheel for air volume control for left center air vent
② Left center air vent, adjustable
③ Right center air vent, adjustable
④ Thumbwheel for air volume control for right center air vent
⑤ Air volume control for side air vent
⑥ Side air vent, adjustable
⑦ Side defroster vent, fixed
⑧ Climate control panel



For draft-free ventilation, move the sliders for the center air vents ②, ③ and ⑥ to the middle position.

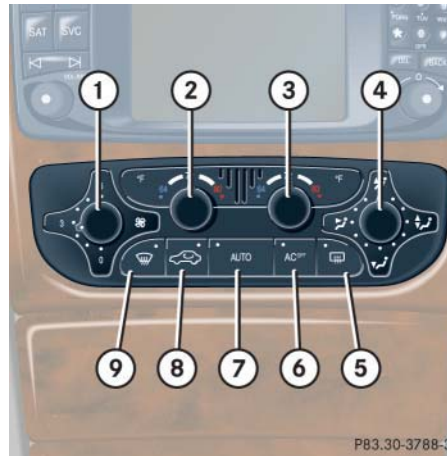

Climate control panel

Controls in detail

Climate control

Item
① Air volume control
② Left-side temperature control
③ Right-side temperature control
④ Air distribution control
⑤ Rear window defroster
⑥ AC cooling on/off (AC^{OFF})
⑦ Air distribution and air volume (automatic mode)
⑧ Air recirculation
⑨ Defrosting

The storage compartment between the front seats can be ventilated (▷ page 160).

Controls in detail

Climate control

The climate control is operational whenever the engine is running. You can operate the climate control system in either the automatic or manual mode. The system cools or heats the interior depending on the selected interior temperature and the current outside temperature.

Warning!



When operating the climate control, the air that enters the passenger compartment through the air vents in the footwell can be very hot or very cold (depending on the set temperature). This may cause burns or frostbite on unprotected skin in the immediate area of the air vents. Always keep sufficient distance between unprotected parts of the body and the footwell air vents. If necessary, change the air flow using the air distribution controls to direct the air away from the footwell air vents (▷ page 157).

Nearly all dust particles, pollutants and odors are filtered out before outside air enters the passenger compartment through the air distribution system.

The air conditioning will not engage (no cooling) if the mode **AC^{OFF}** is selected (▷ page 160).

Warning!



Follow the recommended settings for heating and cooling given on the following pages. Otherwise the windows could fog up, impairing visibility and endangering you and others.

i

Severe conditions (e.g. strong air pollution) may require replacement of the filter before its scheduled interval. A clogged filter will reduce the air volume to the interior.

If the vehicle interior is hot, ventilate the interior before driving off.

Keep the air intake grille in front of the windshield free of snow and debris.

Do not obstruct air flow by placing objects on the air flow-through exhaust slots below the rear window.

Setting the temperature

Use temperature controls ② and ③ (▷ page 155) to separately adjust the air temperature on each side of the passenger compartment. You should raise or lower the temperature setting in small increments, preferably starting at 72°F (22°C).



When operating the climate control system in automatic mode, you will only rarely need to adjust the temperature, air volume and air distribution.

Increasing

- ▶ Turn the temperature control ② or ③ slightly to the right.

The climate control system will correspondingly adjust the interior air temperature.

Decreasing

- ▶ Turn the temperature control ② or ③ slightly to the left.

The climate control system will correspondingly adjust the interior air temperature.

Adjusting air distribution and volume

Use air distribution control ④ (▷ page 155) to adjust the air distribution. The following symbols are found on the controls:

Symbol	Function
	Directs air through the center, side and rear passenger compartment air vents
	Directs air to the windows
	Directs air into the entire vehicle interior
	Directs air to the footwells

Use the air volume control ① (▷ page 155) to adjust the air volume. You can select between six air volume speeds.

Controls in detail

Climate control

Adjusting manually

- ▶ Press button **AUTO** (▷ page 155).
The indicator lamp on the button goes out.
- ▶ Select any of the six air volume speeds and the air distribution.

Adjusting automatically

- ▶ Press button **AUTO** (▷ page 155).
The indicator lamp on the button comes on. The air distribution and volume is adjusted automatically.

Windshield fogged on the outside

- ▶ Switch the windshield wipers on (▷ page 47).
- ▶ Switch to manual mode.
- ▶ Turn the air distribution control to or .

Controls in detail

Climate control

Defrosting



These settings should only be selected for a short time.

Activating

- ▶ Press button  (▷ page 155).

The indicator lamp on the button comes on.

or

- ▶ Switch off air recirculation, if selected. Press button  (▷ page 155).

The indicator lamp on the button goes out.

- ▶ Close center air vents (▷ page 155).
- ▶ Open left and right side air vents (▷ page 155) and adjust side air vents upwards.

Deactivating

- ▶ Press button  (▷ page 155).

The indicator lamp on the button goes out. Defrosting is turned off.

Air recirculation mode

Switch to air recirculation mode to prevent unpleasant odors from entering the vehicle from the outside. This setting cuts off the intake of outside air and recirculates the air in the passenger compartment.

Warning!



When the outside temperature is below 41°F (5°C), only switch to air recirculation mode for short periods to prevent window fogging.

Activating

- ▶ Press button  (▷ page 155).

The indicator lamp on the button comes on.



If you keep button  pressed the side windows and sliding/pop-up roof* will close.

Warning!



Never operate the side windows and the sliding/pop-up roof* if there is the possibility of anyone being harmed by the closing procedure.

In the event that the closing procedure causes potential danger, the closing of the side windows can be immediately halted by pressing or pulling the respective window switch. The closing of the sliding/pop-up roof* can be immediately halted by moving the sliding/pop-up roof* switch in the overhead control panel in any direction.

The closing of the side windows and sliding/pop-up roof* can be reversed by again pressing and holding the  button.



The air recirculation mode is activated automatically at high outside temperatures.

If you have turned off the air conditioning (▷ page 160) or the outside temperature is below 41°F (5°C), the air recirculation mode will not switch on automatically.

Deactivating

- ▶ Press button  (▷ page 155).

The indicator lamp on the button goes out.



If you keep button  pressed the side windows and sliding/pop-up roof* will return to their previous position.

The air recirculation mode is deactivated automatically:

- after five minutes if the outside temperature is below approximately 41°F (5°C)
- after five minutes if the air conditioning is turned off
- after 30 minutes if the outside temperature is above approximately 41°F (5°C)

Controls in detail

Climate control

At outside temperatures above 79°F (26°C) the system will not automatically switch back to outside air. A quantity of outside air is added after approximately 30 minutes.

Deactivating the climate control system

Deactivating

- ▶ Set air volume control ① (▷ page 155) to position **0**.

Reactivating

- ▶ Set air volume control ① (▷ page 155) to any speed.

Controls in detail

Climate control

Air conditioning

The air conditioning is operational while the engine is running and cools the interior air to the temperature set by the operator.



Condensation may drip out from underneath the vehicle. This is normal and not an indication of a malfunction.

Deactivating

It is possible to deactivate the air conditioning (cooling) function of the climate control system. The air in the vehicle will then no longer be cooled or dehumidified.

- ▶ Press button **AC^{OFF}** (▷ page 155).

The indicator lamp on the button comes on.

Activating

Moist air can fog up the windows. You can dehumidify the air with the air conditioning.

- ▶ Press button **AC^{OFF}** (▷ page 155).

The indicator lamp on the button goes out.

The air conditioning uses the refrigerant R134a. This refrigerant is free of CFC's which are harmful to the ozone layer.



If the air conditioning cannot be turned on again, this indicates that the air conditioning is losing refrigerant. The compressor has turned itself off.

Have the air conditioning checked at the nearest authorized Mercedes-Benz Center.

Ventilated storage compartment

The front center console storage compartment has its own air vent that allows for cooling ventilation when the automatic climate control system is activated.



You should keep this air vent closed when outside temperatures are low.

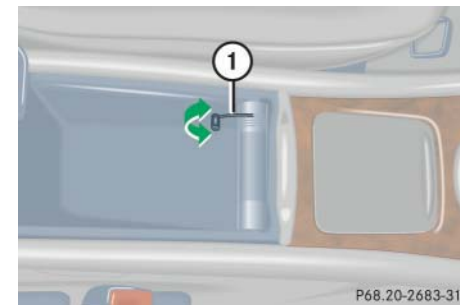

① Lever

Opening the air vent

- ▶ Raise lever ①.

Closing the air vent

- ▶ Lower lever ①.



The compartment can get very warm due to its confined space. When storing heat sensitive objects in the compartment, close the air vent while heating the passenger compartment.



Do not obstruct the air vent in the storage compartment.

Rear passenger compartment adjustable air vents



- ① Left center air vent
- ② Thumbwheel for air volume control for center air vents
- ③ Right center air vent

Controls in detail

Climate control

To open center air vents:

- ▶ Turn thumbwheel ② upward.



The temperature at the center air vents for the rear passenger compartment ① and ③ is the same as at the dashboard center air vents.

Controls in detail

Automatic climate control*

▼ Automatic climate control*

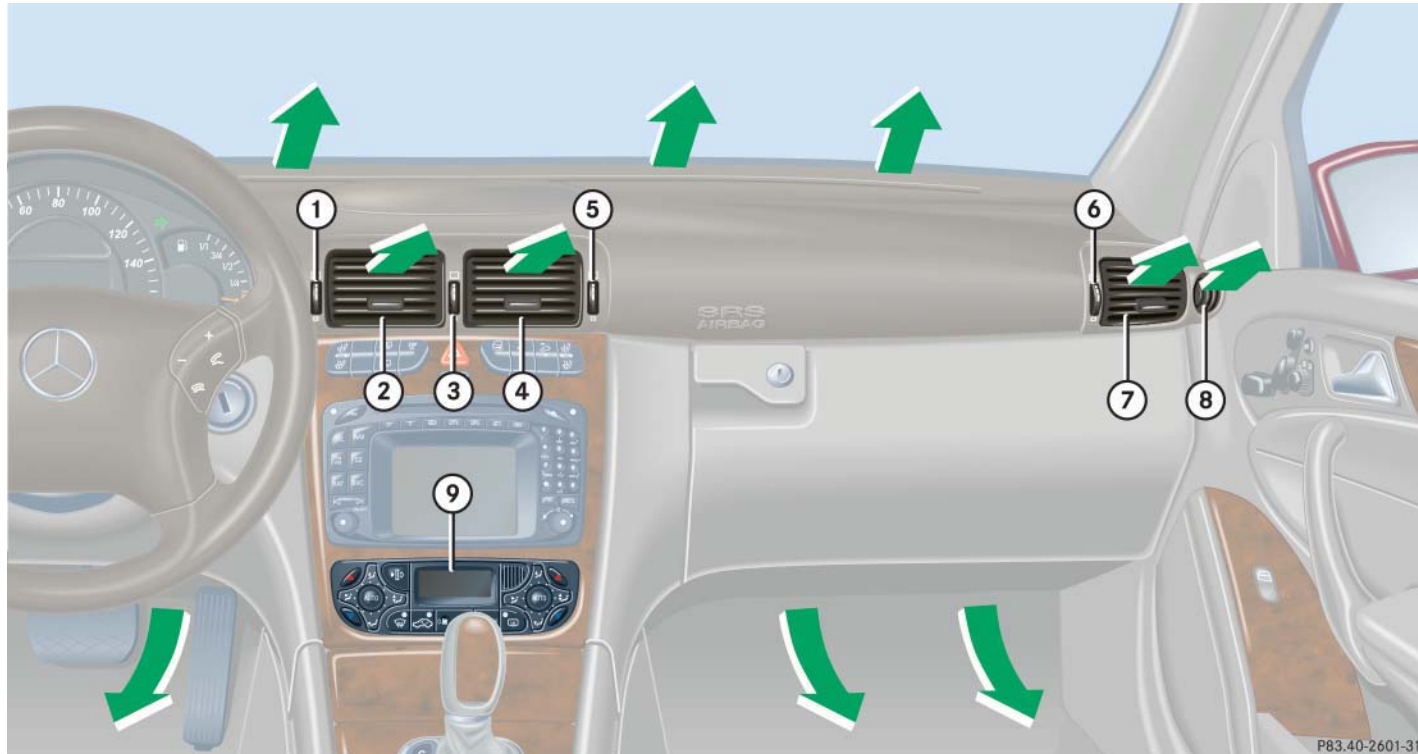

Item
① Thumbwheel for air volume control for left center air vent
② Left center air vent, adjustable
③ Thumbwheel for adding outside air
④ Right center air vent, adjustable
⑤ Thumbwheel for air volume control for right center air vent
⑥ Thumbwheel for air volume control for side air vent
⑦ Side air vent, adjustable
⑧ Side defroster vent, fixed
⑨ Automatic climate control panel

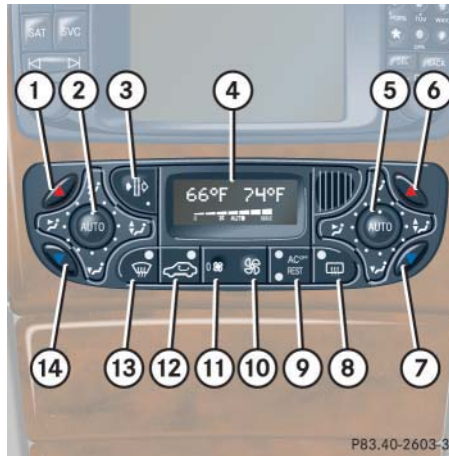

Automatic climate control panel

i For draft-free ventilation, move the sliders for the center air vents ②, ④ and ⑦ to the middle position.

Controls in detail

Automatic climate control*

Item
① Temperature control, left, raising
② Left-side air distribution control (automatic or manual mode)
③ Activated charcoal filter
④ Display
⑤ Right-side air distribution control (automatic or manual mode)
⑥ Temperature control, right, raising
⑦ Temperature control, right, lowering
⑧ Rear window defroster
⑨ AC cooling on/off (AC^{OFF}) Residual heat/ventilation
⑩ Air volume control
⑪ Automatic climate control on/off (complete system)
⑫ Air recirculation
⑬ Defrosting
⑭ Temperature control, left, lowering

Controls in detail

Automatic climate control*

The automatic climate control is operational whenever the engine is running. You can operate the climate control system in either the automatic or manual mode. The system cools or heats the interior depending on the selected interior temperature and the current outside temperature.

Warning!



When operating the automatic climate control, the air that enters the passenger compartment through the air vents in the footwell can be very hot or very cold (depending on the set temperature). This may cause burns or frostbite on unprotected skin in the immediate area of the air vents. Always keep sufficient distance between unprotected parts of the body and the footwell air vents. If necessary, change the air flow using the air distribution controls to direct the air away from the footwell air vents (> page 166).

Nearly all dust particles, pollutants and odors are filtered out before outside air enters the passenger compartment through the air distribution system.

The air conditioning will not engage (no cooling) if the **AC^{OFF}** mode is selected (> page 170).

Warning!



Follow the recommended settings for heating and cooling given on the following pages. Otherwise the windows could fog up, impairing visibility and endangering you and others.



Severe conditions (e.g. strong air pollution) may require replacement of the filter before its scheduled interval. A clogged filter will reduce the air volume to the interior.

If the vehicle interior is hot, ventilate the interior before driving off.

Keep the air intake grille in front of the windshield free of snow and debris.

Do not obstruct air flow by placing objects on the air flow-through exhaust slots below the rear window.

Setting the temperature

Use temperature controls ① and ⑭ for the left side or ⑥ and ⑦ for the right side (▷ page 163) to separately adjust the air temperature on each side of the passenger compartment. You should raise or lower the temperature setting in small increments, preferably starting at 72°F (22°C).



When operating the climate control system in automatic mode, you will only rarely need to adjust the temperature, air volume and air distribution.

Controls in detail

Automatic climate control*

Increasing

- ▶ Push temperature control ① and/or ⑥.

The automatic climate control system will correspondingly adjust the interior air temperature.

Decreasing

- ▶ Push temperature control ⑦ and/or ⑭.

The automatic climate control system will correspondingly adjust the interior air temperature.

Adding outside air





- ▶ Turn thumbwheel ③ in dashboard (▷ page 163) to increase airflow of outside air through air vents for center, left and right sides and rear passenger compartment.

Controls in detail

Automatic climate control*

Adjusting air distribution

Use air distribution controls ② and ⑤ (▷ page 163) to separately adjust the air distribution on each side of the passenger compartment. The following symbols are found on the controls:

Symbol	Function
	Directs air through the center, side and rear passenger compartment air vents
	Directs air to the windows
	Directs air into the entire vehicle interior
	Directs air to the footwells

Adjusting manually

- ▶ Press left or right **AUTO** button (▷ page 163).

The indicator lamp on the button goes out.

Air distribution can be adjusted manually.



Adjusting automatically

- ▶ Press left or right **AUTO** button (▷ page 163).

The indicator lamp on the button comes on.

The air distribution is adjusted automatically.

Windshield fogged on the outside

- ▶ Switch the windshield wipers on (▷ page 47).
- ▶ Switch to manual mode.
- ▶ Turn the air distribution control to  or .

Adjusting air volume

Adjusting manually

Seven blower speeds are available.

- ▶ Press left **0** or right  side of air volume control (▷ page 163) until the requested blower speed is attained.

The display “AUTO” disappears and the automatic mode is switched off. The selected blower speed is shown in the display.

Adjusting automatically

- ▶ Press left or right **AUTO** button (▷ page 163).

The indicator lamp on the button comes on.

The air volume is adjusted automatically.

Controls in detail

Automatic climate control*

Maximum cooling MAXCOOL

If the left and right air distribution controls as well as the airflow volume control are set to **AUTO** and there is a high need for cooling, the display “MAXCOOL” appears.

This provides the fastest possible cooling of the vehicle interior (when windows and sliding/pop-up roof* are closed).

Defrosting



These settings should only be selected for a short time.

Activating

- ▶ Press button  (▷ page 163).

The indicator lamp on the button comes on.

or

- ▶ Switch off air recirculation, if selected.

- ▶ Press button  (▷ page 163).

The indicator lamp on the button goes out.

- ▶ Close center air vents (▷ page 163).
- ▶ Adjust side air vents upwards (▷ page 163).

Deactivating

- ▶ Press button  (▷ page 163).

The indicator lamp on the button goes out. Defrosting is turned off.

Air recirculation mode

Switch to air recirculation mode to prevent unpleasant odors from entering the vehicle from the outside. This setting cuts off the intake of outside air and recirculates the air in the passenger compartment.

Warning!



When the outside temperature is below 41°F (5°C), only switch to air recirculation mode for short periods to prevent window fogging.

Activating

- ▶ Press button  (▷ page 163).

The indicator lamp on the button comes on.

Controls in detail

Automatic climate control*



If you keep button pressed, the side windows and the sliding/pop-up roof* will close.

Warning!



Never operate the side windows and the sliding/pop-up roof* if there is the possibility of anyone being harmed by the closing procedure.

In the event that the closing procedure causes potential danger, the closing of the side windows can be immediately halted by pressing or pulling the respective window switch. The closing of the sliding/pop-up roof* can be immediately halted by moving the sliding/pop-up roof* switch in the overhead control panel in any direction.

The closing of the side windows and sliding/pop-up roof* can be reversed by again pressing and holding the button.



The air recirculation mode is activated automatically:

- at high outside temperatures
- if the concentration of carbon monoxide and nitrogen oxide in the outside air increases, for example in a tunnel (charcoal filter activated)

Please note that the charcoal filter must be activated (▷ page 169) for the air recirculation mode to be activated automatically.

If you have turned off the air conditioning (▷ page 170) or the outside temperature is below 41°F (5°C), the air recirculation mode will not switch on automatically.

Deactivating

- ▶ Press button (▷ page 163).

The indicator lamp on the button goes out.



If you keep button pressed, the side windows and the sliding/pop-up roof* will return to their previous position.

The air recirculation mode is deactivated automatically:

- after five minutes if the outside temperature is below approximately 41°F (5°C)
- after five minutes if the air conditioning is turned off
- after 30 minutes if the outside temperature is above approximately 41°F (5°C)

At outside temperatures above 79°F (26°C) the system will not automatically switch back to outside air. A quantity of outside air is added after approximately 30 minutes.

Charcoal filter

An activated charcoal filter markedly reduces bad odors and removes pollutants from air entering the passenger compartment.

Activating

- ▶ Press button  (▷ page 163).

The indicator lamp on the button comes on.

The system switches automatically to the air recirculation mode if the carbon monoxide (CO) or nitrogen oxide (NO_x) concentration of the outside air increases beyond a predetermined level.



If you keep button  pressed, the side windows and the sliding/pop-up roof* will close.

Warning!



Never operate the side windows and the sliding/pop-up roof* if there is the possibility of anyone being harmed by the closing procedure.

In the event that the closing procedure causes potential danger, the closing of the side windows can be immediately halted by pressing or pulling the respective window switch. The closing of the sliding/pop-up roof* can be immediately halted by moving the sliding/pop-up roof* switch in the overhead control panel in any direction.

The closing of the side windows and sliding/pop-up roof* can be reversed by again pressing and holding the  button.

Controls in detail

Automatic climate control*

Deactivating

- ▶ Press button  (▷ page 163).

The indicator lamp on the button goes out.



If you keep button  pressed, the side windows and the sliding/pop-up roof* will return to their previous position.

The automatic air recirculation mode does not function if the **AC^{OFF}** mode is selected or if the outside temperature has fallen below 41°F (5°C).

The activated charcoal filter should be switched off when windows fog up on the inside, or if the passenger compartment needs to be quickly heated or cooled down.

Controls in detail

Automatic climate control*

Air conditioning

The air conditioning is operational while the engine is running and cools the interior air to the temperature set by the operator.



Condensation may drip out from underneath the vehicle. This is normal and not an indication of a malfunction.

Deactivating

It is possible to deactivate the air conditioning (cooling) function of the automatic climate control system. The air in the vehicle will then no longer be cooled or dehumidified.

- ▶ Press button  (▷ page 163).

The indicator lamp on the button comes on.

Activating

Moist air can fog up the windows. You can dehumidify the air with the air conditioning.

- ▶ Press button  (▷ page 163).

The indicator lamp on the button goes out.

The air conditioning uses the refrigerant R134a. This refrigerant is free of CFCs which are harmful to the ozone layer.



If the air conditioning cannot be turned on again, this indicates that the air conditioning is losing refrigerant. The compressor has turned itself off.

Have the air conditioning checked at the nearest authorized Mercedes-Benz Center.

Controls in detail

Automatic climate control*

Residual heat and ventilation

With the engine switched off, it is possible to continue to heat or ventilate the interior for up to 30 minutes. This feature makes use of the residual heat produced by the engine.

Activating

- ▶ Turn the SmartKey in the starter switch to position **1** or **0**, or remove it from the starter switch.
- ▶ Press button  (▷ page 163).
The indicator lamp on the button comes on.

Deactivating

- ▶ Press button  (▷ page 163).
The indicator lamp on the button goes out.
- The residual heat is automatically turned off:
- when the ignition is switched on
 - after about 30 minutes
 - if the battery voltage drops



How long the system will provide heating depends on the coolant temperature and the temperature set by the operator. The blower will run at speed setting **1** regardless of the air distribution control setting.

Controls in detail

Automatic climate control*

Rear passenger compartment adjustable air vents

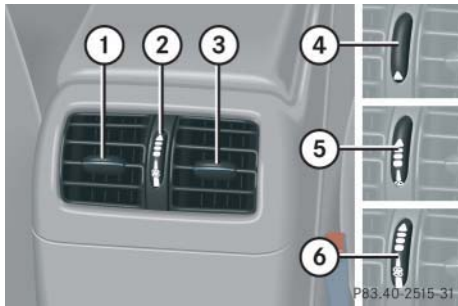

- ① Left center air vent
- ② Thumbwheel for air volume control for center air vents
- ③ Right center air vent
- ④ Closing center air vents
- ⑤ Opening center air vents
- ⑥ Switching on blower

Adjusting the air volume

- ▶ Turn thumbwheel ②.



Four blower speeds are available.

The temperature at the center air vents for the rear passenger compartment ① and ③ is the same as at the dashboard center air vents.

▼ Audio system

Audio and telephone, operation

These instructions are intended to help you become familiar with your Mercedes-Benz audio system. They contain useful tips and a detailed description of the user functions.

Warning!



In order to avoid distraction which could lead to an accident, the driver should enter system settings with the vehicle at a standstill and operate the system only when road and traffic conditions permit. Always pay full attention to traffic conditions first before operating system controls while driving.

Bear in mind that at a speed of just 30 mph (approximately 50 km/h), your car is covering a distance of 50 feet (approximately 14 m) every second.

Operating safety

Warning!



Any alterations made to electronic components can cause malfunctions.

The radio, amplifier, CD changer*, satellite radio*, telephone* and voice control system* are interconnected. When one of the components is not operational or has not been removed/replaced properly, the function of other components may be impaired.

This condition might seriously impair the operating safety of your vehicle.

We recommend that you have any service work on electronic components carried out by an authorized Mercedes-Benz Center.

Controls in detail

Audio system

Operating and display elements

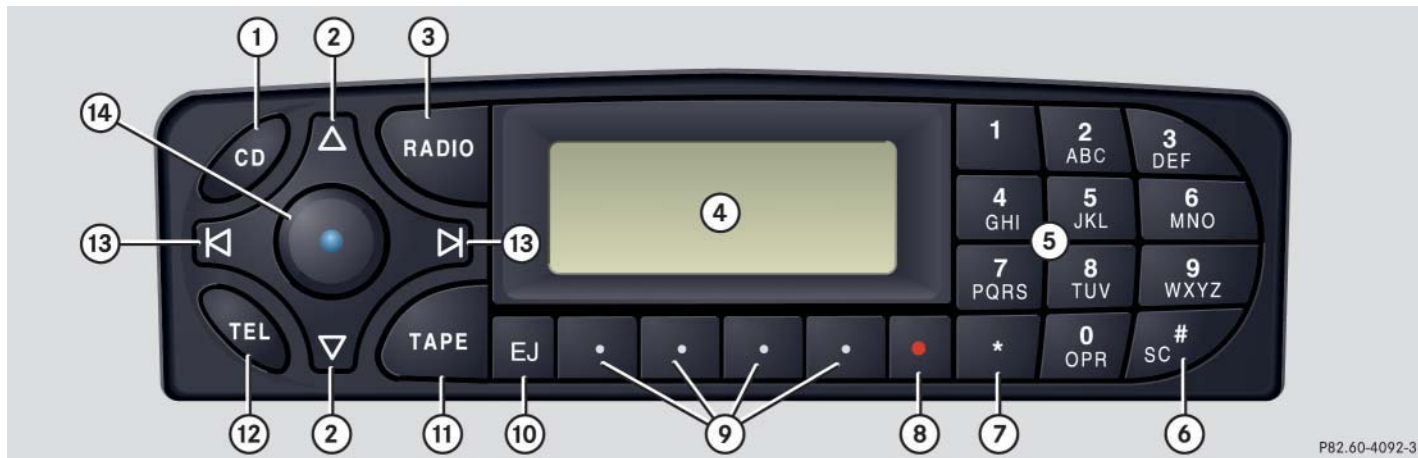

Controls in detail

Audio system

Item	Page
① CD mode selector	189
② Manual tuning (radio)	179
Fast forward/reverse (cassette, CD)	188, 192
Speed dialing memory (telephone*)	197
③ Radio mode selector	179
④ Display panel	
Cassette compartment behind display panel	

Item	Page
⑤ Alpha-numeric keypad	
Band selection, station buttons (radio)	179
CD selection (CD)	191
Telephone number entry, retrieving speed dialing memory (telephone)	194
⑥ Scanning (radio, cassette, CD)	181, 188, 192
⑦ Function button	180
⑧ Light-emitting diode	

Item	Page
⑨ Function keys	
⑩ Cassette eject	187
⑪ Cassette mode selector	186
⑫ Telephone* mode selector	193
⑬ Seek tuning (radio)	180
Track search (cassette, CD)	187, 192
Speed dialing memory (telephone)	197
⑭ On/off	176
Volume	176

Controls in detail

Audio system

Button and soft key operation

In these instructions, the alpha-numeric keypad (right side of radio panel) and the function buttons (left side of radio panel) are referred to as “buttons”. The four keys below the display panel are referred to as “soft keys”.



Do not press directly on the display face. Otherwise, the display will be damaged.

Operation

Switching on/off

Switching on:

- ▶ Turn SmartKey in starter switch to position **1** or **2**.

or

- ▶ Turn control knob



If the radio is switched on without the SmartKey in the starter switch, it will automatically switch off again after approx. 30 minutes.

Switching off:

- ▶ Remove SmartKey from starter switch.

or

- ▶ Turn control knob

Adjusting the volume

- ▶ Turn control knob .

The volume will increase or decrease depending on the direction turned.



The volume setting can be selected separately for the telephone*, audio system and voice control system*.

Adjusting audio functions

Press the AUD key to call up the bass, treble, balance and fader functions in the various operating modes. Settings for bass and treble are stored separately for the AM and FM frequency bands, satellite radio (SAT) mode, cassette mode and CD mode.

Controls in detail

Audio system

Bass

- ▶ Regardless of operating mode, press the **AUD** key repeatedly until **BASS** appears on the display.

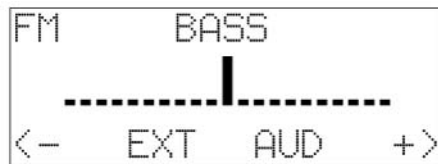

- ▶ Press + or - key to increase or decrease level.
- or
- ▶ Press both + and - keys simultaneously to reset the Bass to its center (flat) level.

Treble

- ▶ Regardless of operating mode, press the **AUD** key repeatedly until **TREBLE** appears on the display.

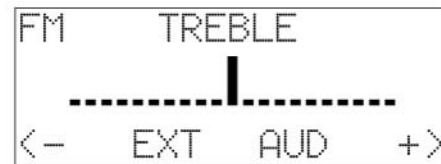

- ▶ Press + or - key to increase or decrease level.
- or
- ▶ Press both + and - keys simultaneously to reset the Treble to its center (flat) level.

Fader



Your vehicle may or may not have the fader function, depending on the vehicle equipment and model.

- ▶ Regardless of operating mode, press the **AUD** key repeatedly until **FADER** appears on the display.

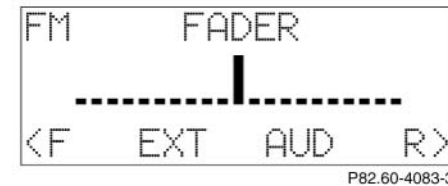

- ▶ Press **F** or **R** key to shift sound accordingly to the front or rear speakers.

or

- ▶ Press both **F** and **R** keys simultaneously to reset the Fader to its center level.

Controls in detail

Audio system

Balance

- ▶ Regardless of operating mode, press the **AUD** key repeatedly until **BALANCE** appears on the display.



P82.60-4084-31

- ▶ Press **L** or **R** key to shift sound accordingly to the left or right speakers.

or

- ▶ Press both **L** and **R** keys simultaneously to reset the Balance to its center level.

Returning audio functions to factory settings



P82.60-4085-31

- ▶ Regardless of operating mode, press and hold **AUD** key longer than two seconds. **RESET** will appear on the display.

All settings for bass, treble and balance are returned to the center level and the volume is set to a predefined level.

Audio system sound selection (EXT)*

- ▶ Regardless of operating mode, press the **AUD** key.

The sound settings menu appears on the display.

- ▶ Press the **EXT** key.



P82.60-4065-31

- ▶ Press one of the function keys.

You can select from among the following settings:

- **DRV:** The tone level is set to the Driver position; sound is directed toward the passengers.
- **SP:** The tone level is set for Speech, optimizing the sound for the spoken word.
- **AMB:** The tone level is set for Ambience, producing a three-dimensional sound.
- **OFF:** The audio system sound selection is turned off.

Telephone* muting

If a telephone has been installed in the vehicle, the radio will switch to telephone mode when a call is incoming. The current audio source is muted.

Radio operation

Selecting radio mode

- ▶ Press **RADIO** button.
- ▶ You can now receive radio stations over the analog FM, AM or WB station frequencies or you can receive channels digitally via satellite radio (SAT)*.

Analog station frequencies

Selecting the band

You can select from among FM, AM or WB frequency bands.

Weather band (▷ page 182).



FM frequency band:
FM 87.7.....107.9 MHz
AM frequency band:
MW (medium wave) 530.....1710 KHz

- ▶ Press FM, AM or WB key repeatedly until desired band has been selected.

The FM, AM and WB frequency bands are called up one after the other.

The frequency band currently selected appears in the upper left-hand corner of the display.

Selecting a station

The following options are available for selecting a station:

- Direct frequency band input (▷ page 180)
- Manual tuning (▷ page 180)
- Automatic seek tuning (▷ page 180)
- Scan tuning (▷ page 181)
- Preset buttons (▷ page 181)
- Automatic station memory (Autostore) (▷ page 181)

Controls in detail

Audio system

Direct frequency input

Select the desired frequency band.



P82.60-4061-31

- ▶ Press ***** button.
- ▶ Enter desired frequency using buttons **1** to **0**.



You can only enter frequencies within the respective waveband.

If a button is not pressed within four seconds, the radio will return to the station last tuned to.

Manual tuning

▶ Select the desired frequency band.



P82.60-4057-31

- ▶ Press and hold either the **▲** or **▼** button until the desired frequency is reached.

Step-by-step station tuning takes place in ascending or descending order of frequency. The first three tuning steps will take place without muting. Afterwards, the radio will be muted and highspeed tuning will take place until the button is released.

Automatic seek tuning

▶ Select the desired frequency band.



P82.60-4059-31

- ▶ Press either the **▶** or **◀** button.
The radio will tune to the next higher or next lower receivable frequency.

Controls in detail

Audio system

Scan tuning

- Starting scan tuning
 - ▶ Select desired frequency band.



- ▶ Press **SC#** button.
SC will appear on the display. The radio briefly tunes in all receivable stations on the band selected. The first scan cycle will tune in only the stations with a strong signal. The second scan cycle will tune in every receivable station.
- Ending scan tuning
 - ▶ Press **SC#** button or **▲**, **▼**, **▶** or **◀** button.
SC disappears from the display.

Manual station memory (Presets)

You can store ten AM and ten FM stations.

- Storing stations
 - ▶ Tune in the desired station.
 - ▶ Press and hold desired station button **1** to **0** until a brief signal tone is heard.



The frequency is stored on the selected station button.

The frequency band and station button number are shown in the upper left-hand corner of the display.

- Retrieving a station from memory
 - ▶ Press desired station button **1** to **0**.

Automatic station memory (Autostore)

The Autostore memory function provides an additional memory level. The station memory for manually stored stations is not overwritten.

- Calling up Autostore memory level
 - ▶ Briefly press the AS key.

AS is highlighted in the display.

The radio finds the ten stations with the strongest signals. These stations are stored on the station buttons **1** to **0** in order of signal strength.

- Retrieving a station from memory
 - ▶ Press desired station button **1** to **0**.
- Leaving the Autostore memory level
 - ▶ Press the AS key.

The highlighted AS in the display disappears.

Controls in detail

Audio system

Weather band



P82.60-4060-31

- ▶ Press the WB key.
The weather band station last selected is tuned in.
- ▶ Select the desired weather band station with buttons **1** to **7** PQRS.
If a station cannot be tuned in, a scan is automatically started.
- ▶ Press **▶** or **◀** button. The next receivable weather band station is tuned in.

Satellite radio (SAT)* (USA only)



Additional optional satellite radio equipment and a subscription to satellite radio service provider is required for the satellite radio operation described here. Feature description is based on preliminary information available at time of printing.

At time of printing, no date for the availability of optional equipment required for satellite radio operation had been set. Contact your authorized Mercedes-Benz Center for details and availability for your vehicle.

Satellite radio service may be unavailable or interrupted from time to time for a variety of reasons, such as environmental or topographic conditions and other things we can't control. Service might also not be available in certain places (e.g., in tunnels, parking garages, or within or next to buildings) or near other technologies.

Sirius Satellite Radio provides 100 channels of digital-quality radio, among others music, sports, news, and entertainment, free of commercials. Sirius Satellite Radio uses a fleet of high-power satellites to broadcast 24 hours per day coast-to-coast.

This diverse, satellite-delivered programming is available for a monthly subscription fee.

For more information, call the Sirius service or contact www.siriusradio.com

Program categories

The channels are categorized. The categories allow you to tune to stations broadcasting a certain type of program (PTY mode) (▷ page 185).

Starting satellite radio (SAT)

- ▶ Start radio mode.

If the radio was in SAT radio mode before being turned off or changed to another operating mode, the last SAT channel selected is called up.

or

- ▶ Press the SAT key.

When you call up the SAT radio mode for the first time, ACQUIRING will appear on the display during the initialization process.

or



The last channel selected is called up.

Entering the Electronic Serial Number (ESN)

The first time SAT radio is called up, you must give your SAT radio provider the Electronic Serial Number (ESN) of your SAT receiver over the telephone.

- ▶ Press the SAT key.

The radio switches to SAT mode.

CALL SIRI appears on the display.



- ▶ Press the ESN key.

The provider's phone number will appear first. After pressing the ESN key again, the ESN number will appear.

Make note of the phone number and ESN number.

Controls in detail

Audio system

- ▶ Press the ESN key repeatedly until all required information has appeared on the display.
- ▶ Call the telephone number and give provider your ESN number.



Credit card information is also required for your application.

The activation process takes approximately five to ten minutes after calling the SIRIUS Service Center.

Controls in detail

Audio system

Channel selection

The following options are available for selecting a channel:

- ▶ Direct channel input (▷ page 184)
- ▶ Manual tuning (▷ page 184)
- ▶ Preset channels (▷ page 184)

Direct channel input



P82.60-4064-31

- ▶ Press ***** key.
- ▶ Enter desired channel number using buttons **1** to **0**.



Only inputs for available channels are possible.

If a button is not pressed within four seconds, the radio will return to the last station tuned.

Manual tuning

- ▶ Press and hold **▶**, **▲**, **▼** or **◀** button until the desired channel has been reached.

Preset channels

You can store up to ten channels.

- Retrieving a channel from memory
 - ▶ Press the desired channel button **1** to **0**.

- Storing channels

- ▶ Tune in the desired channel.
- ▶ Press and hold desired channel button **1** to **0** until a brief signal tone sounds.



P82.60-4062-31

The channel is stored on the selected channel button.

Program type (PTY) mode

In PTY mode, you can tune in and select channels of a specific program type.

Calling up PTY mode

- ▶ Start SAT radio mode.
- ▶ Press the **PTY** key.
The name of the channel currently being received is shown.

Leaving PTY mode

- ▶ Press the **CH** key.
The number of the channel currently being received is shown.

Selecting channel category

- ▶ Press **▲** or **▼** button.
The individual program types are selected.

Tuning in a PTY channel

Once you have selected a program type, you can tune in channels broadcasting a program that corresponds to the selected program type.

- ▶ Press **▶** or **◀** button.
The radio will tune to the next highest or lowest channel broadcasting this type of program.

Program Descriptive Text (PDT)

In PDT mode, you can call up additional information on the channel, the current track and the performing artist(s).

- ▶ Press the **TXT** key.
The station category appears on the display.
- ▶ Press the **TXT** key again within four seconds.
The title of the current track appears.
- ▶ Press the **TXT** key again within four seconds.
The name of the musician(s) of the current track appear on the display.

Controls in detail

Audio system

Cassette operation

Playing cassettes

- ▶ Press **[EJ]** button.

The display panel folds down and the cassette compartment becomes accessible.

- ▶ Insert cassette into the cassette compartment until it engages and tap it gently.

The cassette will be pulled in automatically. The system switches to cassette mode. Side 1 will be played and **SIDE 1** appears in the display. Side 1 is the side of the cassette which is facing upward. The cassette deck will automatically detect the type of tape.

- ▶ Fold display panel back up and press gently on the display panel frame to lock it in place.



Do not press directly on the display face. Otherwise the display will be damaged.

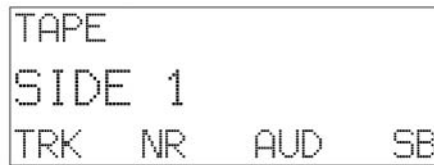

P82.60-4071-31

or

- ▶ If a cassette is already in the mechanism, press **[TAPE]** button.



A warning signal will sound after 20 seconds if the display panel is left in the down position. Fold display panel back up. If the display panel is not closed, a warning signal will sound and the radio will be muted.

Track selection

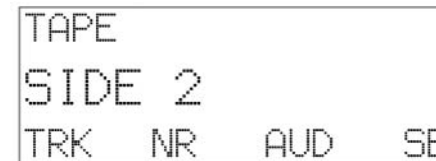

P82.60-4072-31

- ▶ Press the **TRK** key.
The current track will be displayed as **SIDE 1** or **SIDE 2**.
- ▶ You can switch sides at any time.
The side will be changed automatically at the end of the tape.

Cassette eject

- ▶ Press eject button **[EJ]**.
The display folds down and the cassette is ejected. The system will switch back to radio mode automatically.
- ▶ Fold display panel back up and press gently on the display panel frame to lock it.



Do not press directly on the display face. Otherwise the display will be damaged.



The cassette will not be ejected when the system is switched off or switched to another operating mode.

Track search

Track search forward



P82.60-4073-31

- ▶ Press **[▶]** button.
SEEK FWD will appear in the display. Track search will run the tape forward to the start of the next track and switch to Play.



The beginning of a track can only be found if there is pause of at least four seconds between tracks.

Controls in detail

Audio system

Track search backward

- ▶ Press **[◀]** button.
SEEK RWD will appear on the display. Track search will run the tape backward to the start of the track currently playing and switch to Play.

Stopping track search

- ▶ Press **[▲]**, **[▼]**, **[▶]** or **[◀]** button.
The cassette will switch over to Play.

Controls in detail

Audio system

Scanning

- Starting scan



- ▶ Press **SC#** button.

SC will appear on the display.

Each track on the cassette will be played briefly in ascending order.

- Stopping scan

- ▶ Press **SC#**, **△**, **▽**, **▶** or **◀** button.

The system will switch to Play.

Fast forward/reverse

- Starting cassette fast forward mode



- ▶ Press **△** button.

FORWARD will appear on the display.

- Starting cassette fast reverse mode

- ▶ Press **▽** button.

REWIND will appear on the display.

The cassette will automatically switch over to the play mode at the end or beginning of the tape.

- Stopping the cassette fast forward/reverse mode

- ▶ Press **△**, **▽**, **▶** or **◀** button.

The cassette will switch over to the play mode.

Skipping blank sections (skip blank)

Switching on the skip blank function

- ▶ Press the SB key.

SB is highlighted in the display.

If the system does not detect a sound signal, the cassette will automatically fast forward to the next sound signal.

Switching off the skip blank function

- ▶ Press the SB key.

The highlighted SB in the display disappears.

Dolby NR¹ (noise reduction system)

To enable optimum sound reproduction of cassettes recorded using Dolby B NR, the Dolby NR system should be switched on.



The Dolby NR function should be switched off when playing cassettes not recorded with Dolby B NR.

Switching on

- ▶ Press the NR key.
NR is highlighted in the display.

Switching off

- ▶ Press the NR key.
The highlighted NR in the display disappears.

CD changer* operation

General notes

Should excessively high temperatures occur while in CD mode, CD TEMP HIGH will appear on the display and the CD will be muted. The unit will then switch back to the last operating mode used until the temperature has decreased to a safe operating level.

CD 5
CD TEMP LOW
RDM RPT AUD T

P82.60-4066-31

Should excessively low temperatures occur while in CD mode, CD TEMP LOW will appear on the display, but the CD will continue to play.

Handle CDs carefully to prevent interference during playback. Avoid fingerprints and dust on CDs. Do not write on CDs or apply any labels or other material to them.

¹ DOLBY and the double-D symbol are trademarks of Dolby Laboratories Licensing Corporation.

The Dolby noise reduction system is manufactured under license from Dolby Laboratories Licensing Corporation.

Controls in detail

Audio system

Only use original CDs. Using copied CDs may create problems during playback.

Clean CDs from time to time with a commercially available cleaning cloth. Do not use solvents, anti-static sprays, etc. for cleaning. Replace the CD in its case after use. Protect CDs from heat and direct sunlight.



Only use CDs, which bear the label shown and that conform to the compact disc digital audio standard (IEC 60908). You can therefore only use CDs with a maximum thickness of 1.3 mm.



Use of CDs which do not meet this standard may cause damage to the CD changer. Do not play single-CDs (80 mm) with an adapter.

Your CD drive has been designed to play CDs which correspond to the EN 60908 standard.

If you insert thicker data carriers, e.g. ones that have data on both sides (one side with DVD data, the other side with audio data), they cannot be ejected and will damage the drive.

Warning!



The CD changer* is a Class 1 laser product. There is a danger of invisible laser radiation if the cover is opened or damaged. Do not remove the cover. The CD changer* does not contain any parts which can be serviced by the user. For safety reasons, have any service work which may be necessary performed only by qualified personnel.

Operational readiness of CD changer

If a CD changer has been installed in the system, it can be operated from the front control panel of the radio. A loaded magazine must be installed to play CDs.

Loading/unloading the CD magazine

- ▶ Slide changer door to the right and press eject button .
- ▶ The magazine will be ejected.

Controls in detail

Audio system

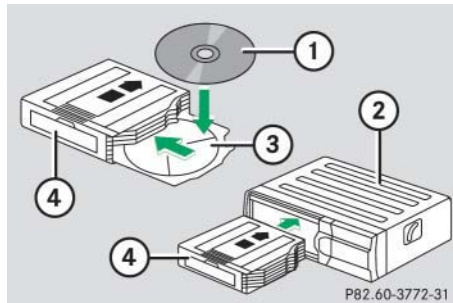

- ① CD
- ② CD changer
- ③ CD tray
- ④ CD magazine

- ▶ Remove magazine and pull CD tray fully out.
- ▶ Place CD in recess of tray, label side up.
- ▶ Push tray into magazine in direction of arrow.



CDs which have been inserted improperly or are unreadable will not be played.

- ▶ Push magazine into CD changer in direction of arrow and close sliding door.

Playing CDs

- ▶ Press **CD** button.

CD will appear on the display.

The last CD listened to will then start playing at the point where it was switched off. After the last track on a CD has finished, the next CD is automatically played.

Selecting CDs

```
CD 2
TRACK 1
RDM RPT AUD T
```

P82.60-4067-31

- ▶ You can select from among the CDs in the CD magazine using buttons **1** to **6**.

CD and the magazine slot number of the selected CD appear on the display. The number of the current track is displayed after TRACK.

```
CD 2
NO CD 5
RDM RPT AUD T
```



P82.60-4068-31



If there is no CD in the selected magazine slot, NO CD appears on the display with the corresponding slot number.

Controls in detail

Audio system

Skipping tracks forward/backward

- Skipping tracks forward
 - ▶ Press  button.
The next track will be played.
- Skipping tracks backward
 - ▶ Press  button.
If the track has been playing for more than ten seconds, it will revert to the start of that track. If it has been playing for less than ten seconds, it will revert to the preceding track.

Pressing the  or  button repeatedly will result in multiple tracks being skipped.

Fast forward/reverse

- Fast forward
 - ▶ Press and hold  button until desired point has been reached.

- Fast reverse
 - ▶ Press and hold  button until desired point has been reached.



The relative time of the track is shown on the display during the search.

Scanning

- Starting scan
 - ▶ Press **SC#** button.







CD 2 SC
TRACK 5
RDM RPT AUD T

P82.60-4069-31

SC appears in the display.

Each track on the current CD will be played for approx. eight seconds in ascending order.

- Ending scan
 - ▶ Press **SC#**, , ,  or  button.

Random play

The random play function (RDM) plays the tracks on the current CD in random order.

- Switching on random play



CD 2
TRACK 1
RDM RPT AUD T

P82.60-4067-31

- ▶ Press the RDM key.
RDM is highlighted in the display.
- Switching off random play
 - ▶ Press the RDM key.
The highlighted RDM in the display disappears.

Repeat

The repeat function (RPT) repeats the current track.

Switching on repeat:



P82.60-4067-31

- ▶ Press the RPT key.
RPT is highlighted in the display.

Switching off repeat:

- ▶ Press the RPT key.
The highlighted RPT in the display disappears.



The Random play and Repeat function cannot be used simultaneously.

Track and time display



P82.60-4070-31

- ▶ Press the T key.
The number of the track being played and the elapsed playing time appear in the display.
- ▶ Press the T key.
The total number of tracks and the total playing time of the CD appear in the display.
The CD main menu appears again after eight seconds.

Telephone* operation

Various car telephone* functions and operating steps for the car telephone can be performed and displayed via the audio system.

Further operating instructions not covered here can be found in the operating instructions for the multifunction steering wheel, voice control* and the telephone*.

Controls in detail

Audio system

Switching on the telephone

- ▶ Press **TEL** button.
If you have programmed an unlock code for the telephone, you must enter the code now.
- ▶ Enter the desired telephone number using buttons **1** to **0**.
- ▶ If necessary, correct number entered with the CLR key. Press key briefly to delete the last digit entered; press key and hold to delete the complete number.
- ▶ Press the OK key after entering correct code.
The telephone is unlocked. If you have entered the wrong code, you must repeat the entering procedure with the correct code.

Switching off the telephone

- ▶ Press **TEL** button repeatedly until PHONE OFF appears in the display.
The receiving symbol in the display disappears.

Adjusting the volume

- ▶ Turn control knob  during telephone operation.

The volume increases or decreases depending on the direction in which the knob is turned.



The volume can be adjusted separately for the telephone*, voice control system* and radio.

Placing a call

Entering a telephone number and starting the dialing process

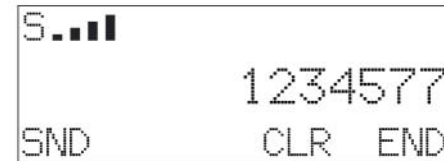

- ▶ Enter the desired telephone number using buttons **1** to **0**.
The number can have up to 32 digits, but only 13 of these are visible on the display.
If necessary, correct number entered with the CLR key.
- ▶ Press key briefly to delete the last digit entered.
- ▶ Press key and hold to delete the complete number.
- ▶ After correct telephone number has been entered, press the SND key.

Phone book

The numbers stored in the phone book can be called up either by name or number.

Calling up the phone book

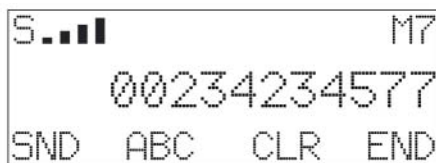

P82.60-4077-31

- ▶ Press , ,  or  button.

Switching between name search and number search

- ▶ Press the ABC key.
The name search is called up.

or

- ▶ Press the NUM key.
The number search is called up.

Searching and calling up phone book entries by name

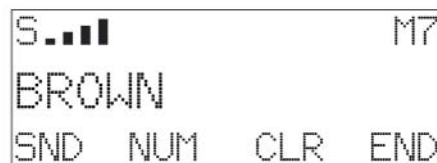



P82.60-4078-31



- ▶ Press the ABC key.
The current name is highlighted on the display.

Controls in detail



Audio system

- ▶ Press either the  or  button.
The stored entries are selected according to the alphabetical order of the initial letter.

or

- ▶ Press either the  or  button.
The stored entries are selected in increments of four.

or

- ▶ Press the desired numerical key  to .
The stored entries are selected according to the alphabetical order of the initial letters (e.g. for B -Brown, press button  twice).

i

Several characters and symbols cannot be shown on the display for technical reasons. They have been replaced with spaces.



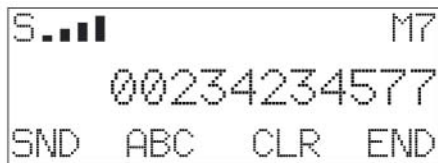

Controls in detail

Audio system

Searching and selecting phone book entries by number



P82.60-4077-31

- ▶ Press the NUM key.
The current number is marked in the display.
 - ▶ Press either the  or  button.
The stored entries are selected according to numerical order.
- or
- ▶ Press either the  or  button.
The stored entries are selected in increments of 5 (e.g. Entry M5, Entry M10, etc.)

Starting dialing process

- ▶ Once you have selected a number, press the SND key.



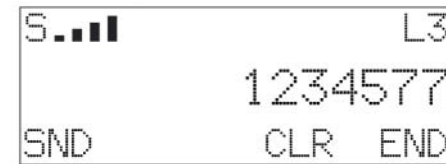

Repeat dialing

If the number dialed is busy, you can again place calls to the last ten telephone numbers dialed using the repeat dialing function.

Manual repeat dialing (redial)



P82.60-4079-31

- ▶ Press the SND key.
The last number dialed is shown in the display.
- ▶ Select the desired telephone number using , ,  or  button.
The abbreviation L and the number of the entry are shown in the top line of the display.
- ▶ When you have selected a number, press the SND key.
The call will be made.

Automatic repeat dialing (redial)

If a call cannot be connected, press the **SND** key.

REDIAL will appear on the display and repeated attempts to place the call will be made for the next four minutes.

Selecting numbers directly from the directory

- ▶ Enter previously selected 3-digit (1-999) number of the entry using number keys **1** to **0**.
- ▶ Press the **RCL** key.
The telephone number stored under that entry will be dialed.
- ▶ Press the **SND** key.
The call will be made.

Speed dialing

- ▶ Input desired entry number using number keys **1** to **0**.

A maximum of two digits can be entered.

If necessary, correct the last number entered with the **CLR** key.

- ▶ Press the **SND** key.

The telephone number stored under that entry will be dialed. The number, **L** and the full entry number will be shown in the display.

Quick-dialing

- ▶ Press one of the desired number buttons **1** to **0** longer than one second.

The telephone number saved under that number will be dialed.



Please be aware that button **1** might already be reserved for an emergency call number.

Controls in detail

Audio system

Emergency call

- ▶ Press button **1** longer than one second.
- ▶ A call will be placed to the saved number (e.g. 911).



Please be aware that the 911 emergency call system is a public service. Using it without due cause is a criminal offense.

You can make an emergency call to an emergency rescue station with a mobile communications network.

The emergency call will be placed as long as the corresponding mobile communications network is available. To do this, switch the telephone on if this has not already been done.

The call will also be placed even if the unlock code is not entered.

Emergency calls may not be possible with all telephone networks or if certain network services and/or telephone functions are active. Check with your local network operation company. It may take some time to set up an emergency call.

To use this function you must ensure that the number stored in memory location 1 is the number to be dialed in case of emergency.

If an emergency call cannot be connected, the message `SYSTEM BUSY` appears.

Accepting an incoming call

Accepting an incoming call in telephone mode

With an incoming call, a ringing tone can be heard and the caller's telephone number, or the name under which this telephone number has been saved in the telephone book, appears on the display. If the caller's number is not transmitted, `CALL` will appear in the display.

- ▶ Press the `SND` key to accept call.

Accepting an incoming call in cassette, CD or radio mode

If the telephone is activated in the background (receiving symbol **S** visible on display), the audio source is muted when a call is received. The ringing tone is heard and the caller's telephone number or the name under which this telephone number has been saved in the telephone book appears on the display. If the caller's number is not transmitted, **CALL** appears in the display.

- ▶ Press the **SND** key to accept the call.

Muting a call

It is possible to mute a call; the caller is then no longer able to hear you.

Mute on

- ▶ Press the **MUT** key.

Mute off

- ▶ Press the **MUT** key.

Terminating a call

- ▶ Press the **END** key.

The current call is terminated.

Call waiting

If you receive another call during an already active call, you can accept the second call and switch between the two.

Accepting a second call

- ▶ Press the **SND** key.

You are connected with the second caller, the first call is muted.

Switching between the calls

- ▶ Press the **SND** key.

Terminating the second call

- ▶ Press the **END** key.

The current call will be terminated. You are connected with the muted call again.

Controls in detail

Power windows

▼ Power windows

Opening and closing the windows

The side windows can be opened and closed electrically. The switches for all the side windows are on the driver's door. The switches for the respective windows are on the front passenger door and the rear doors.



- ① Left front window
- ② Right front window
- ③ Right rear window
- ④ Left rear window
- ⑤ Rear window override switch
(▷ page 70)

Warning!



When closing the windows, make sure there is no danger of anyone being harmed by the closing procedure.

The closing of the door windows can be immediately halted by releasing the switch or, if switch was pulled past the resistance point and released, by either pressing or pulling the respective switch.



If the window encounters an obstruction that blocks its path in a circumstance where you pulled the switch past the resistance point and released it to close the window, the automatic reversal function will stop the window and open it slightly.

If the window encounters an obstruction that blocks its path in a circumstance where you are closing the window by pulling and holding the switch, or by pressing and holding the button  on the SmartKey the automatic reversal function will not operate.

When leaving the vehicle, always remove the SmartKey from starter switch, take it with you, and lock your vehicle. Do not leave children unattended in the vehicle, or with access to an unlocked vehicle. Unsupervised use of vehicle equipment can cause an accident and/or serious personal injury.

i

You can also open or close the windows using the:

- SmartKey (summer opening/convenience feature) (▷ page 202).
- button  in the control panel of the climate control (▷ page 155) or the automatic climate control* (▷ page 163)
- button  in the control panel of the automatic climate control* (▷ page 163)

- ▶ Turn SmartKey in the starter switch to position **1** or **2**.

Opening the windows

- ▶ Press switch ① to ④ to the resistance point.

The corresponding window will move downwards until you release the switch.

Closing the windows

- ▶ Pull switch ① to ④ to the resistance point.

The corresponding window will move upwards until you release the switch.

Warning!



If you pull and hold the switch up when closing the window, and upward movement of the window is blocked by some obstruction including but not limited to arms, hands, fingers, etc., the automatic reversal will not operate.

Fully opening the windows (Express-open)

- ▶ Press switch ① to ④ past the resistance point and release.

The corresponding window opens completely.

Fully closing the windows (Express-close)

- ▶ Pull switch ① to ④ past the resistance point and release.

The corresponding window closes completely.



If the upward movement of the window is blocked during the closing procedure, the window will stop and open slightly.

Remove the obstruction, pull the switch again past the resistance point and release.

Controls in detail

Power windows

If the window still does not close when there is no obstruction, then pull and hold the switch again. The side window will then close without the obstruction sensor function

Warning!



Driver's door only:

If within five seconds you again pull the switch past the resistance point and release, the automatic reversal will not function.

Stopping windows

- ▶ Press or pull respective switch again.

Controls in detail

Power windows



Opening and closing the windows with the SmartKey

The sliding/pop-up roof* (▷ page 204) will also be opened or closed when the power windows are operated with the SmartKey .

Warning!



Never operate the windows or sliding/pop-up roof* if there is the possibility of anyone being harmed by the opening or closing procedure.

In the event that the procedure causes potential danger, the procedure can be immediately halted by releasing the transmit button on the SmartKey. To reverse direction of movement, press button  for opening or  for closing.

- ▶ Aim transmitter eye at the driver's door handle.

Opening (Summer opening feature)

- ▶ Press and hold button  after unlocking the vehicle.

The windows and sliding/pop-up roof* begin to open after approximately one second.

- ▶ Release the  button to stop procedure.

Closing (Convenience feature)

- ▶ Press and hold button  after locking the vehicle.

The windows and sliding/pop-up roof* begin to close after approximately one second.

- ▶ Release the  button to stop procedure.

Make sure all side windows and the sliding/pop-up roof* are properly closed before leaving the vehicle.

Synchronizing power windows

The power windows must be resynchronized each time

- after the battery has been disconnected.
- if the power windows cannot be fully opened (Express-open) or closed (Express-close).

Synchronizing

- ▶ Switch on ignition.
- ▶ Pull the power window switches until the side windows are closed.
Hold the switches for approximately one second.
The power windows are adjusted.

Controls in detail

Sliding/pop-up roof*

▼ Sliding/pop-up roof*

Opening and closing the sliding/pop-up roof

The sliding/pop-up roof can be opened and closed electrically. The switch for the sliding/pop-up roof is on the overhead control panel.



- ① Push up to raise roof at rear
- ② Pull down to lower roof at rear
- ③ Push forward to slide roof closed
- ④ Push back to slide roof open

With the roof closed or tilted open, a screen can be slid into the roof opening to guard against sun rays. When sliding the roof open, the screen will also retract.

Warning!



When closing the sliding/pop-up roof, make sure there is no danger of anyone being harmed by the closing procedure.

The closing procedure of the sliding/pop-up roof can be immediately halted by releasing the switch or, if the switch was moved past the resistance point and released, by moving the switch in any direction.

When leaving the vehicle, always remove the SmartKey from starter switch, and lock your vehicle. Do not leave children unattended in the vehicle, or with access to an unlocked vehicle. Unsupervised use of vehicle equipment can cause an accident and/or serious personal injury.



To avoid damaging the seals, do not transport any objects with sharp edges which can stick out of the sliding/pop-up roof.

Do not open the sliding/pop-up roof if there is snow or ice on the roof, as this could result in malfunctions.



The sliding/pop-up roof can be opened or closed manually should an electrical malfunction occur (▷ page 309).

Controls in detail

Sliding/pop-up roof*



You can also open or close the sliding/pop-up roof using the:

- SmartKey (summer opening/convenience feature) (▷ page 204)
- button  in the control panel of the climate control (▷ page 155) or the automatic climate control* (▷ page 163)
- button  in the control panel of the automatic climate control* (▷ page 163)

- ▶ Turn SmartKey in the starter switch to position **1** or **2**.

Opening and closing the sliding/pop-up roof

- ▶ To open, close, raise or lower the sliding/pop-up roof, move the switch to resistance point in the required direction ① to ④.

Release the switch when the roof has reached the desired position.

Fully opening (Express-open) and closing (Express-close) the sliding/pop-up roof

- ▶ To open, close, raise or lower the sliding/pop-up roof, move the switch past the resistance point in the required direction ① to ④ and release.

The sliding/pop-up roof opens or closes completely.

Stopping the sliding/pop-up roof

- ▶ Move the switch in any direction.



If the movement of the sliding/pop-up roof is blocked during the closing procedure, the roof will stop and reopen slightly.



Opening and closing the sliding/pop-up roof with the SmartKey

The power windows (▷ page 202) will also be opened or closed when you operate the sliding/pop-up roof with the SmartKey .

Warning!



Never operate the windows or sliding/pop-up roof* if there is the possibility of anyone being harmed by the opening or closing procedure.

In the event that the procedure causes potential danger, the procedure can be immediately halted by releasing the transmit button on the SmartKey. To reverse direction of movement, press button  for opening or  for closing.

- ▶ Aim transmitter eye at the driver's door handle.

Controls in detail

Sliding/pop-up roof*

Opening (Summer opening feature)

- ▶ Press and hold button  after unlocking the vehicle.

The windows and the sliding/pop-up roof begin to open after approximately one second.

- ▶ Release the  button to stop procedure.

Closing (Convenience feature)

- ▶ Press and hold button  after locking the vehicle.

The windows and the sliding/pop-up roof begin to close after approximately one second.

- ▶ Release the  button to stop procedure.

Make sure all side windows and the sliding/pop-up roof are properly closed before leaving the vehicle.

Synchronizing the sliding/pop-up roof

The power sliding/pop-up roof must be resynchronized each time

- after the battery has been disconnected.
- after the sliding/pop-up roof has been closed manually.
- if the sliding/pop-up roof does not open smoothly.
- after a malfunction.

Synchronizing

- ▶ Switch on ignition.
- ▶ Press and hold the switch in direction ① until the sliding/pop-up roof is fully raised at the rear.

Hold the switch for approximately one second.

The sliding/pop-up roof is adjusted.

Controls in detail

Driving systems

▼ Driving systems

The driving system of your vehicle is described on the following pages:

- Cruise control, with which the vehicle can maintain a preset speed

For information on the BAS, ABS and ESP driving systems, see “Driving safety systems” (▷ page 72).

Cruise control

Cruise control automatically maintains the speed you set for your vehicle.

Use of cruise control is recommended for driving at a constant speed for extended periods of time. You can set or resume cruise control at any speed over 20 mph (30 km/h).

The cruise control function is operated by means of the cruise control lever.

The cruise control lever is the uppermost lever found on the left-hand side of the steering column (▷ page 20).

Warning!



Cruise control is a convenience system designed to assist the driver during vehicle operation. The driver is and must remain at all times responsible for the vehicle speed and for safe brake operation.

Only use cruise control if the road, traffic and weather conditions make it advisable to travel at a steady speed.

- The use of cruise control can be dangerous on winding roads or in heavy traffic because conditions do not allow safe driving at a steady speed.
- The use of cruise control can be dangerous on slippery roads. Rapid changes in tire traction can result in wheel spin and loss of control.
- Deactivate cruise control when driving in fog.

The “Resume” function should only be operated if the driver is fully aware of the previously set speed and wishes to resume this particular preset speed.

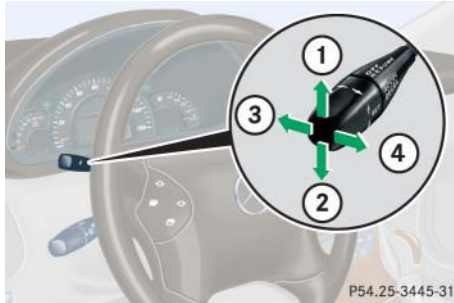

- ① Set current or higher speed
- ② Set current or lower speed
- ③ Cancel cruise control
- ④ Resume at last set speed

Setting current speed

- ▶ Accelerate or decelerate to the desired speed.
- ▶ Briefly lift ① or depress ② cruise control lever.
The current speed is set.
- ▶ Remove your foot from the accelerator pedal.
Cruise control is activated.



On uphill or downhill grades, cruise control may not be able to maintain the set speed. Once the grade eases, the set speed will be resumed.

Canceling cruise control

There are several ways to cancel cruise control:

- ▶ Step on the brake pedal.
- or
- ▶ Briefly push cruise control lever to position ③.

Cruise control will be canceled. The last speed set will be stored for later use.



Vehicles with automatic transmission:
Moving gear selector lever to position **N** while driving also cancels cruise control. However, the gear selector lever should not be moved to position **N** while driving except to coast when the vehicle is in danger of skidding (e.g. on icy roads).



Vehicles with manual transmission:
The set cruise controlled speed is switched off when declutching exceeds four seconds during downshifting a gear.



The last stored speed is canceled when you turn off the engine.

Controls in detail

Driving systems

Setting a higher speed

- ▶ Lift cruise control lever to position ① and hold it up until the desired speed is reached.
- ▶ Release cruise control lever.
The new speed is set.



Depressing the accelerator pedal does not deactivate cruise control. After brief acceleration (e.g. for passing), cruise control will resume the last speed set.

Setting a lower speed

- ▶ Depress cruise control lever to position ② and hold it down until the desired speed is reached.
- ▶ Release cruise control lever.
The new speed is set.



Vehicles with automatic transmission: When you use the cruise control lever to decelerate, the transmission will automatically downshift if the engine's braking power does not brake the vehicle sufficiently.

Fine adjustment in 1 mph (Canada: 1 km/h) increments

Faster

- ▶ Briefly tip cruise control lever in the direction of arrow ①.

Slower

- ▶ Briefly tip cruise control lever in the direction of arrow ②.

Setting to last stored speed ("Resume" function)

Warning!



The speed stored in memory should only be set again if prevailing road conditions permit. Possible acceleration or deceleration differences arising from returning to preset speed could cause an accident and/or serious injury to you and others.

- ▶ Briefly push cruise control lever to position ④.
The cruise control will resume the last set speed.
- ▶ Remove your foot from the accelerator pedal.

▼ Loading

Roof rack*

Warning!



Only use roof racks approved by Mercedes-Benz for your vehicle model to avoid damage to the vehicle. Follow manufacturer's installation instructions.

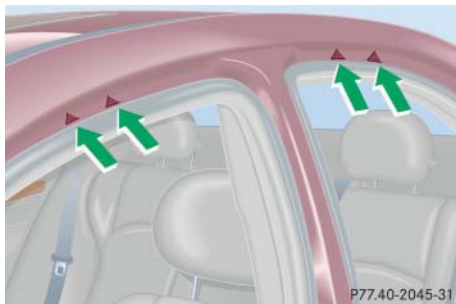

- ▶ Mount the roof rack only to the fastening bolts (see arrows) located under the door weatherstrips.
- ▶ Secure the roof rack according to manufacturer's instructions for installation.



Load the roof rack in such a way that the vehicle cannot be damaged while driving.

Make sure

- you can fully raise the sliding/pop-up roof*.
- you can fully open the trunk.

Controls in detail

Loading

Ski sack*



- ① Handle
- ② Cover
- ③ Armrest

Unfolding and loading

- ▶ Fold armrest ③ down (arrow).
- ▶ Pull handle ① and swing cover ② down.



Controls in detail

Loading



④ Velcro strap

- ▶ Unfasten velcro strap ④.
- ▶ Pull ski sack into passenger compartment and unfold.

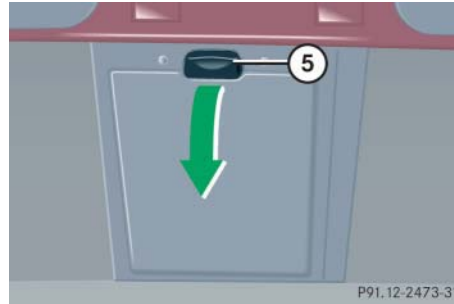

⑤ Button

- ▶ Open trunk lid.
- ▶ Press button ⑤.
The flap opens downward.

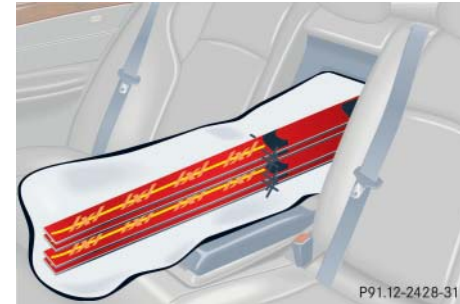

- ▶ From trunk, slide skis into ski sack.

Warning!



The ski sack is designed for up to four pairs of skis. Do not load the ski sack with other objects.

Always fasten the ski sack securely. In an accident, an unfastened ski sack can cause injury to vehicle occupants.

Controls in detail

Loading



⑥ Strap

- ▶ Tighten strap ⑥ by pulling at the loose end (arrow) until the skis in the ski sack are tightly secured.

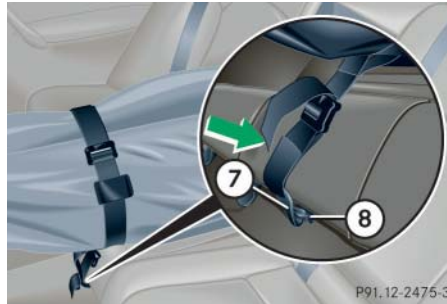

⑦ Hook

⑧ Eye

- ▶ Connect hook ⑦ to eye ⑧.
Tighten strap by pulling at the loose end (arrow).

Unloading and folding

- ▶ Loosen the straps.
- ▶ Disconnect hook ⑦ from eye ⑧.
- ▶ Unload skis.
- ▶ Close flap in trunk.
- ▶ Fold and flatten ski sack lengthwise.
- ▶ Place folded ski sack inside recess of backrest.
- ▶ Fasten velcro strap.
- ▶ Close ski sack compartment cover.

Controls in detail

Loading

Removing the ski sack

You can remove the ski sack for cleaning or drying.

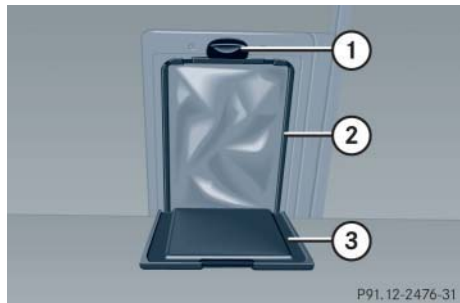

- ① Button
- ② Ski sack frame
- ③ Flap

- ▶ Open trunk lid.
- ▶ Press button ①.
- ▶ The flap ③ opens downward.
- ▶ Press button ① firmly until ski sack frame ② is released.
- ▶ Pull ski sack frame ② with ski sack out.

Warning!



Never drive vehicle with trunk open while the ski sack is removed. Deadly carbon monoxide (CO) gases may enter vehicle interior, resulting in unconsciousness and death.



To prevent unauthorized persons from accessing the trunk, always close the flap.

Installing the ski sack

Install the ski sack in the reverse order.

- ▶ Push ski sack frame ② with ski sack inward until the ski sack frame snaps into place.
- ▶ Close flap ③.
- ▶ Close trunk lid.

Split rear bench seat*

To expand the cargo area, you can fold down the left and right rear seat backrests.

The two sections can be folded down separately.

Warning!



When expanding the luggage area, always fold the seat cushions fully forward.

Unless you are transporting cargo, the backrests must remain properly locked in the upright position.

In an accident, during hard braking or sudden maneuvers, loose items will be thrown around inside the vehicle, and cause injury to vehicle occupants unless the items are securely fastened in the vehicle.

Folding the backrest forward

The release handle ① is located in the trunk.



- ▶ Pull release handle ①.
- ▶ Fully retract and fold rearward head restraints (▷ page 95).

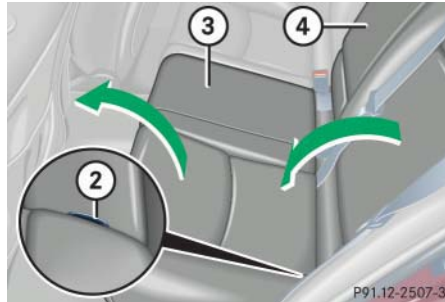

- ▶ Pull release handle ②.
- ▶ Fold seat cushion ③ forward.
- ▶ Fold backrest ④ forward.

Setting up rear seat bench

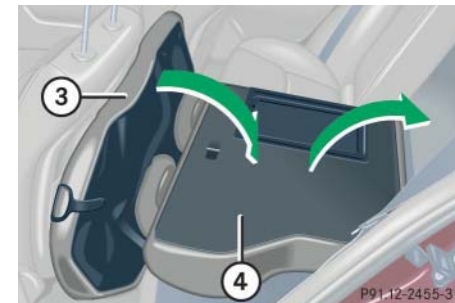

- ▶ Fold backrest ④ rearward until it engages.
- ▶ Fold seat cushion ③ rearward until it locks into position.

Controls in detail

Loading

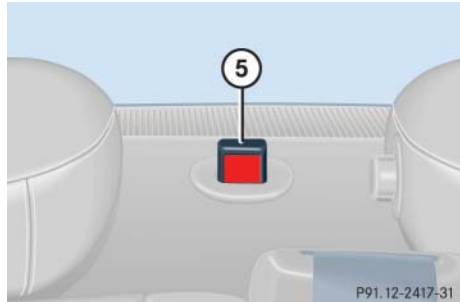

If the backrest is not locked into position, a red indicator ⑤ will be visible.

- ▶ Check for secure locking by pushing and pulling on the backrest.

Warning!



If a red indicator is visible with the backrest up, then the backrest is not properly locked into position.

Always lock backrest in its upright position when rear seat bench is occupied, cargo is being carried in the trunk, or the extended cargo compartment is not in use. Check for secure locking by pushing and pulling on the backrest.

In an accident, during hard braking or sudden maneuvers, loose items will be thrown around inside the vehicle, and cause injury to vehicle occupants unless the items are securely fastened in the vehicle.

To help avoid personal injury during a collision or sudden maneuver, exercise care when transporting cargo.



To prevent unauthorized persons from access to the trunk, always lock backrest in its upright position.

Loading instructions

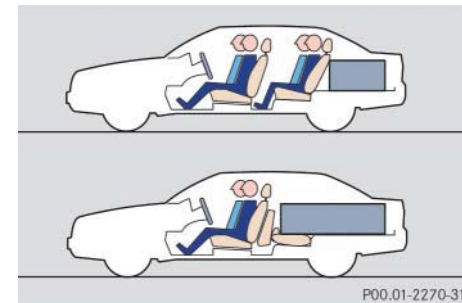

The total load weight including vehicle occupants and luggage/cargo should not exceed the vehicle capacity weight indicated on the certification tag which can be found on the left door pillar.

The handling characteristics of a fully loaded vehicle depend greatly on the load distribution. It is therefore recommended to load the vehicle according to the illustrations shown, with the heaviest items being placed towards the front of the vehicle.

Always place items being carried against front or rear seat backrests, and fasten them as securely as possible.

The heaviest portion of the cargo should always be kept as low as possible since it influences the handling characteristics of the vehicle.

Warning!



Always fasten items being carried as securely as possible.

In an accident, during hard braking or sudden maneuvers, loose items will be thrown around inside the vehicle and can cause injury to vehicle occupants unless the items are securely fastened in the vehicle.

To help avoid personal injury during a collision or sudden maneuver, exercise care when transporting cargo.

Never drive vehicle with trunk open. Deadly carbon monoxide (CO) gases may enter vehicle interior resulting in unconsciousness and death.

Controls in detail

Loading



The trunk is the preferred place to carry objects.

The enlarged cargo area should only be used for items which do not fit in the trunk alone.

Controls in detail

Useful features

▼ Useful features

Interior storage spaces

Warning!



To help avoid personal injury during a collision or sudden maneuver, exercise care when stowing objects in the vehicle. Put luggage or cargo in the trunk if possible. Do not pile luggage or cargo higher than the seat backs. Do not place anything on the shelf below the rear window.

Luggage nets cannot secure hard or heavy objects.

Keep compartment lids closed. This will help to prevent stored objects from being thrown about and injuring vehicle occupants during an accident.

Glove box

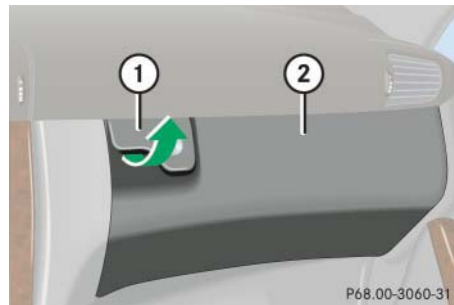

- ① Glove box lid release
- ② Glove box

Opening the glove box

- ▶ Pull lid release ①.
The glove box lid opens downward.

Closing the glove box

- ▶ Push lid up to close.



Prior to closing the glove box, close the compartment for glasses first.

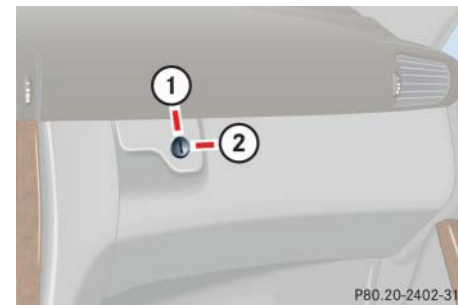

Locking the glove box

- ▶ Insert mechanical key (▷ page 305) into the glove box lock and turn it to position ②.

Unlocking the glove box

- ▶ Turn mechanical key (▷ page 305) in the glove box lock to position ①.

Cup holder in front of seat armrest

Warning!



When not in use, keep the cup holder closed. Place only containers that fit into the cup holder to prevent spills. Use lids on open containers and do not fill containers to a height where the contents, especially hot liquids, could spill during vehicle maneuvers.

Opening cup holder



- ▶ Slide cover ① rearward.
- ▶ Push button ②.

The cup holder opens automatically.

Closing cup holder

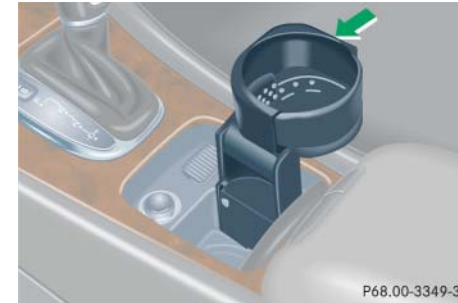

- ▶ Push in direction of arrow until cup holder engages.

Controls in detail

Useful features

Cup holder in rear seat armrest

Warning!



When not in use, keep the cup holder closed. Place only containers that fit into the cup holder to prevent spills. Use lids on open containers and do not fill containers to a height where the contents, especially hot liquids, could spill during vehicle maneuvers.

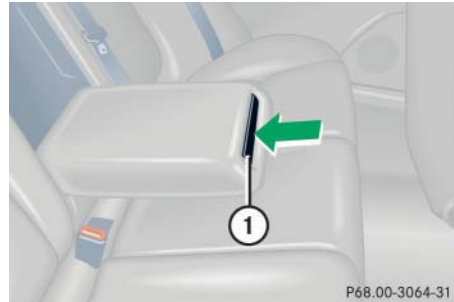

P68.00-3064-31

Opening cup holder

- ▶ Push front of sliding compartment ①. The cup holder slides out.

Closing cup holder

- ▶ Push sliding compartment ① back until it engages.

Storage compartment in front of armrest

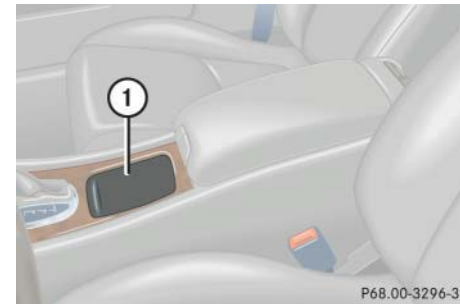

P68.00-3296-31

Opening

- ▶ Slide cover ① rearward.

The compartment contains a cigarette lighter (▷ page 221), a coin holder and a cup holder (▷ page 217).

Closing

- ▶ Slide cover ① forward.

Armrest storage spaces

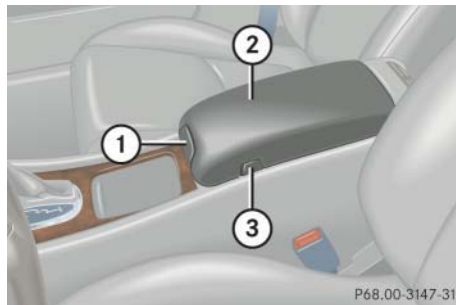

- ① Handle
- ② Armrest
- ③ Button

Opening storage compartment

- ▶ Pull handle ① and lift armrest.

Closing storage compartment

- ▶ Press armrest down until it engages into place.

Opening telephone compartment

- ▶ Press button ③ on driver's or passenger side and lift armrest.

Closing telephone compartment

- ▶ Press armrest down until it engages into place.

Changing inclination of armrest

- ▶ Pull up on armrest.

Lowering armrest

- ▶ Pull handle ① to lower armrest.



Vehicles with climate control:

The storage compartment can be heated or cooled.

The compartment can get very warm due to its confined space. When storing heat sensitive objects in the compartment, close the air vent (▷ page 160) while heating the passenger compartment.



Vehicles with climate control:

Do not obstruct the air vent in the storage compartment.

Controls in detail

Useful features

Parcel net in front passenger footwell

A small convenience parcel net is located in the front passenger footwell. It is for small and light items, such as road maps, mail, etc.

Warning!



Do not place heavy or fragile objects, or objects having sharp edges, in the parcel net.

In an accident, during hard braking or sudden maneuvers, they could be thrown around inside the vehicle, and cause injury to vehicle occupants.

Ashtrays

Center console ashtray

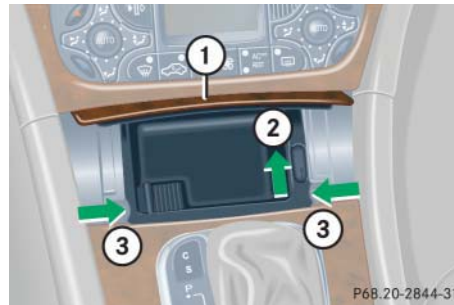

Opening ashtray

- ▶ Briefly touch cover plate ①.
The ashtray opens automatically.

Removing ashtray insert

Warning!



Remove front ashtray only with vehicle standing still. Set the parking brake to secure vehicle from movement. Move gear selector lever to position **N**. With gear selector lever in position **N** turn off the engine.

- ▶ Secure vehicle from movement by setting the parking brake. Move the gear selector lever to position **N**.
Now you have more room to take out the insert.
- ▶ Slide ashtray insert in direction of arrow ② until it disengages.
- ▶ Grip ashtray at indents (arrows ③) and remove insert from ashtray frame.

Reinstalling ashtray insert

- ▶ Install insert by pushing back into frame until it engages again.

Rear seat ashtray

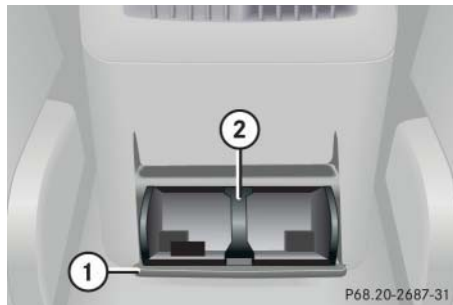

Opening ashtray

- ▶ Pull at top of cover ② to open ashtray.

Removing ashtray insert

- ▶ Press latch ① to disengage ashtray insert and remove it.

Reinstalling the ashtray insert

- ▶ Install ashtray insert.
- ▶ Close the ashtray.

Cigarette lighter

The cigarette lighter is located in the center console compartment in front of the armrest.



- ① Cigarette lighter
- ② Cover

- ▶ Turn SmartKey in the starter switch to position **1** or **2**.
- ▶ Slide cover ② rearward.
- ▶ Push in cigarette lighter ①.

The cigarette lighter will pop out automatically when hot.

Warning!



Never touch the heating element or sides of the lighter; they are extremely hot. Hold the knob only.

When leaving the vehicle, always remove the SmartKey from the starter switch, and lock your vehicle. Do not leave children unattended in the vehicle, or with access to an unlocked vehicle. Unsupervised use of vehicle equipment may cause an accident and/or serious personal injury.



The lighter socket can be used to accommodate electrical accessories up to a maximum 85 W.

Controls in detail

Useful features

Telephone*

Warning!



Never operate radio transmitters equipped with a built-in or attached antenna (i.e. without being connected to an external antenna) from inside the vehicle while the engine is running. Doing so could lead to a malfunction of the vehicle's electronic system, possibly resulting in an accident and personal injury.

Radio transmitters, such as a portable telephone or a citizens band unit, should only be used inside the vehicle if they are connected to an antenna that is installed on the outside of the vehicle.

The external antenna must be approved by Mercedes-Benz. Please contact an authorized Mercedes-Benz Center for information on the installation of an approved external antenna. Refer to the radio transmitter operation instructions regarding use of an external antenna.

Warning!





Please do not forget that your primary responsibility is to drive the vehicle. A driver's attention to the road must always be his/her primary focus when driving. For your safety and the safety of others, we recommend that you pull over to a safe location and stop before placing or taking a telephone call.

If you choose to use the telephone¹ while driving, please use the hands-free device and only use the telephone when road, weather and traffic conditions permit. Some jurisdictions prohibit the driver from using a cellular telephone while driving a vehicle.

Only operate the COMAND* (Cockpit Management and Data System)¹ if road, weather and traffic conditions permit.

Bear in mind that at a speed of just 30 mph (approximately 50 km/h), your vehicle is covering a distance of approx. 44 feet (approximately 13.5 m) every second.

¹ Observe all legal requirements.

You can take and place telephone calls using the  and  buttons on the steering wheel. To carry out other telephone functions, use the control system (▷ page 138).

See separate operating manual for instructions on how to use the telephone.

Warning!



Some jurisdictions prohibit the driver from using a cellular telephone while driving a vehicle. Whether or not prohibited by law, for safety reasons, the driver should not use the cellular telephone while the vehicle is in motion.

Stop the vehicle in a safe location before answering or placing a call.

Tele Aid*



The initial activation of the Tele Aid system may only be performed by completing the subscriber agreement and placing an acquaintance call using the SOS button. Failure to complete either of these steps will result in a system that is not activated. If the system is not activated, the indicator lamp in the SOS button stays on after turning SmartKey in starter switch to position **2** and the message TELE AID EMERG. CALL - NOT ACTIVATED will be shown in the multifunction display for approximately ten seconds.

If you have any questions regarding activation, please call the Response Center at 1-800-756-9018 (in the USA) or 1-888-923-8367 (in Canada).

The Tele Aid system



(Telematic Alarm Identification on Demand)

The Tele Aid system consists of three types of response:

- automatic and manual emergency
- roadside assistance and
- information

The Tele Aid system is operational providing that the vehicle's battery is charged, properly connected, not damaged and cellular and GPS coverage is available.

The speaker volume of a Tele Aid call can be adjusted when using the volume control on the multifunction steering wheel. To raise, press button **+** and to lower, press button **-**.



- ▶ To activate, press the SOS button, the Roadside Assistance button  or the Information button , depending on the type of response required.

Controls in detail

Useful features



The SOS button is located above the interior rear view mirror.

The Roadside Assistance button  and the Information button  are located below the center armrest cover.

Shortly after the completion of your Tele Aid acquaintance call, you will receive a user ID and password via first call mail. By visiting www.mbusa.com and selecting "Tele Aid" (USA only), you will have access to account information, remote door unlock, Info Services profile and more.





The Tele Aid system utilizes the cellular network for communication and the GPS (Global Positioning System) satellites for vehicle location. If either of these signals are unavailable, the Tele Aid system may not function and if this occurs, assistance must be summoned by other means.

Controls in detail

Useful features

System self-check

Initially, after turning the SmartKey in starter switch to position **2**, malfunctions are detected and indicated (the indicator lamps in the SOS button, the Roadside Assistance button  and the Information button  stay on longer than ten seconds or do not come on). The message TELE AID MALFUNCTION - DRIVE TO WORKSHOP! appears for approximately ten seconds in the multifunction display.



The Tele Aid system utilizes the cellular network for communication and the GPS (Global Positioning System) satellites for vehicle location. If either of these signals are unavailable, the Tele Aid system may not function and if this occurs, assistance must be summoned by other means.

Warning!



If the indicator lamps in the SOS button, in the Roadside Assistance button and/or in the Information button remain illuminated constantly in red and/or the message TELE AID MALFUNCTION - DRIVE TO WORKSHOP! is displayed in the multifunction display after the system self-check, a malfunction in the system has been detected.

If a malfunction is indicated as outlined above, the system may not operate as expected. Have the system checked at the nearest Mercedes-Benz Center as soon as possible.

Emergency calls

An emergency call is initiated automatically

- following an accident in which the emergency tensioning devices (ETDs) or airbags deploy.
- if the anti-theft alarm or the tow-away alarm stays on for more than 20 seconds. See anti-theft alarm system (▷ page 78) and tow-away alarm (▷ page 79).

An emergency call can also be initiated manually by opening the cover next to the interior rear view mirror labeled “SOS”, then briefly pressing the button located under the cover. See (▷ page 226) for instructions on initiating an emergency call manually.

Once the emergency call is in progress, the indicator lamp in the SOS button will begin to flash. The message EMERGENCY CALL - CONNECTING CALL appears in the multifunction display. When the connection is established, the message

EMERGENCY CALL - CALL CONNECTED appears in the multifunction display. All information relevant to the emergency, such as the location of the vehicle (determined by the GPS satellite location system), vehicle model, identification number and color are generated.

A voice connection between the Response Center and the occupants of the vehicle will be established automatically soon after the emergency call has been initiated. When a voice connection is established, the audio system mutes and the message TELE AID - EMERGENCY CALL ACTIVE appears in the multifunction display. The Response Center will attempt to determine more precisely the nature of the accident provided they can speak to an occupant of the vehicle.

The Tele Aid system is available if:

- it has been activated and is operational. Activation requires a subscription for monitoring services, connection and cellular air time
- the relevant cellular phone network and GPS signals are available and pass the information on to the response center



Location of the vehicle on a map is only possible if the vehicle is able to receive signals from the GPS satellite network and pass the information on to the response center.

Controls in detail

Useful features

Warning!



If the indicator lamp in the SOS button is illuminated continuously and there was no voice connection to the Response Center established, then the Tele Aid system could not initiate an emergency call (e.g. the relevant cellular phone network is not available). The message EMERGENCY CALL - CALL FAILED appears in the multifunction display for approximately ten seconds.

Should this occur, assistance must be summoned by other means.

Controls in detail

Useful features

Initiating an emergency call manually



- ① Cover
- ② SOS button

- ▶ Briefly press on cover ①.
The cover will open.
- ▶ Press SOS button ② briefly.
The indicator lamp in SOS button ② will flash until the emergency call is concluded.
- ▶ Wait for a voice connection to the Response Center.
- ▶ Close cover ① after the emergency call is concluded.

Warning!



If you feel at any way in jeopardy when in the vehicle (e.g. smoke or fire in the vehicle, vehicle in a dangerous road location), please do not wait for voice contact after you have pressed the emergency button. Carefully leave the vehicle and move to a safe location. The Response Center will automatically contact local emergency officials with the vehicle's approximate location if they receive an automatic SOS signal and cannot make voice contact with the vehicle occupants.

Roadside Assistance button

Located below the center armrest cover is the Roadside Assistance button .

- ▶ Press and hold button (for longer than two seconds).

A call to a Mercedes-Benz Roadside Assistance dispatcher will be initiated. The button will flash while the call is in progress. The message **TELE DIAGNOSIS - CONNECTING CALL** will appear in the multifunction display.

When the connection is established, the message **TELE DIAGNOSIS - CALL CONNECTED** appears in the multifunction display. The Tele Aid system will transmit data generating the vehicle identification number, model, color and location (subject to availability of cellular and GPS signals).

A voice connection between the Roadside Assistance dispatcher and the occupants of the vehicle will be established. When a voice connection is established, the audio

system mutes and the message TELE AID - ROADSIDE ASSISTANCE CALL ACTIVE appears in the multifunction display.



- ▶ Describe the nature of the need for assistance.

The Mercedes-Benz Roadside Assistance dispatcher will either dispatch a qualified Mercedes-Benz technician or arrange to tow your vehicle to the nearest authorized Mercedes-Benz Center. For services such as labor and/or towing, charges may apply. Refer to the Roadside Assistance manual for more information.

These programs are only available in the USA:

- Sign and Drive services: Services such as jump start, a few gallons of fuel or the replacement of a flat tire with the vehicle spare tire are obtainable.
- Remote Vehicle Diagnostics: This function permits the Mercedes-Benz Roadside Assistance dispatcher to download malfunction codes and actual vehicle data.



The indicator lamp on the Roadside Assistance button  remains illuminated in red for approximately ten seconds during the system self-check after turning the SmartKey in the starter switch to position **2** (together with the SOS button and the Information button .

See system self-check (> page 224) when the indicator lamp does not come on in red or stays on longer than approximately ten seconds.

If the indicator lamp on the Roadside Assistance button  is illuminated continuously and there was no voice connection to the Response Center established, then the Tele Aid system could not initiate a Roadside Assistance call (e.g. the relevant cellular phone network is not available). The message TELE DIAGNOSIS - CALL FAILED appears in the multifunction display.

Controls in detail

Useful features

Roadside Assistance calls can be terminated using the  button on the multifunction steering wheel.

Information button

Located below the center armrest cover is the Information button .

- ▶ Press and hold button (for longer than two seconds).

A call to the Customer Assistance Center will be initiated. The button will flash while the call is in progress. The message INFO - CONNECTING CALL will appear in the multifunction display.

When the connection is established, the message INFO - CALL CONNECTED appears in the multifunction display. The Tele Aid system will transmit data generating the vehicle identification number, model, color and location (subject to availability of cellular and GPS signals).



Controls in detail

Useful features

A voice connection between the Customer Assistance Center representative and the occupants of the vehicle will be established. When a voice connection is established, the audio system mutes and the message TELE AID - INFO CALL ACTIVE appears in the multifunction display. Information regarding the operation of your vehicle, the nearest Mercedes-Benz Center or Mercedes-Benz USA products and services is available to you.

For more details concerning the Tele Aid system, please visit www.mbusa.com and use your ID and password (sent to you separately) to learn more (USA only).



The indicator lamp on the Information button  remains illuminated in red for approximately ten seconds during the system self-check after turning the SmartKey in the starter switch to position **2** (together with the SOS button and the Roadside Assistance button ).

See system self-check (▷ page 224) when the indicator lamp does not come on in red or stays on longer than approximately ten seconds.

If the indicator lamp on the Information button  is illuminated continuously and there was no voice connection to the Response Center established, then the Tele Aid system could not initiate an Information call (e.g. the relevant cellular phone network is not available). The message INFO - CALL FAILED appears in the multifunction display.

Information calls can be terminated using the  button on the multifunction steering wheel.



If the indicator lamps do not start flashing after pressing one of the buttons or remain illuminated (in red) at any time, the Tele Aid system has detected a fault or the service is not currently active, and may not initiate a call. Visit your Mercedes-Benz Center and have the system checked or contact the Response Center at 1-800-756-9018 (in the USA) or 1-888-923-8367 (in Canada) as soon as possible.

Controls in detail

Useful features

Upgrade signals

The Tele Aid system processes calls using the following priority:

- Automatic emergency – First priority
- Manual emergency – Second priority
- Roadside assistance – Third priority
- Information – Fourth priority

Should a higher priority call be initiated while you are connected, an upgrade (alternating) tone will be heard, and the appropriate indicator lamp will flash. If certain information such as vehicle identification number or customer information is not available, the operator may need to retransmit.

During this time you will hear a beep and voice contact will be interrupted. Voice contact will resume once the retransmission is completed. Once a call is concluded, a beep will be heard and the respective indicator lamp will stop flashing. The COMAND* system operation will resume.



If the indicator lamp continues to flash or the system does not reset, contact the Response Center at 1-800-756-9018 (in the USA) or 1-888-923-8367 (in Canada), or Mercedes-Benz Customer Assistance at 1-800-FOR-MERCEdes (1-800-367-6372) in the USA or Customer Service at 1-800-387-0100 in Canada.



The indicator lamp in the respective button flashes until the call is concluded. Calls can only be terminated by a Response Center or Customer Assistance Center representative except Roadside Assistance and Information calls, which can also be terminated by pressing button  on the multifunction steering wheel.



When a Tele Aid call has been initiated, the audio system or the COMAND* system audio is muted and the selected mode (radio, tape or CD) pauses. The optional cellular phone (if installed) switches off. If you must use this phone, the vehicle must be parked. Disconnect the coiled cord and place the call. The COMAND* navigation system (if engaged) will continue to run. The display in the instrument cluster is available for use, and spoken commands are only available by pressing the RPT button on the COMAND* unit. A pop-up window will appear in the COMAND* display to indicate that a Tele Aid call is in progress.

Controls in detail

Useful features

Remote door unlock

In case you have locked your vehicle unintentionally (e.g. SmartKey inside vehicle), and the reserve SmartKey is not handy:

- ▶ Contact the Mercedes-Benz Response Center at 1-800-756-9018 (in the USA) or 1-888-923-8367 (in Canada).

You will be asked to provide your password which you provided when you completed the subscriber agreement.

- ▶ Then return to your vehicle and pull the trunk recessed handle for a minimum of 20 seconds until the SOS button is flashing.

The message **EMERGENCY CALL - CALL CONNECTED** appears in the multifunction display.

As an alternative, you may unlock the vehicle via Internet using the ID and password sent to you shortly after the completion of your acquaintance call.

The Response Center will then unlock your vehicle with the remote door unlocking feature.



The remote door unlock feature is available if the relevant cellular phone network is available.

The SOS button will flash and the message **EMERGENCY CALL - CALL CONNECTED** will appear in the multifunction display to indicate receipt of the door unlock command.

Once the vehicle is unlocked, a Response Center specialist will attempt to establish voice contact with the vehicle occupants.

If the trunk recessed handle was pulled for more than 20 seconds before door unlock authorization was received by the Response Center, you must wait 15 minutes before pulling the trunk recessed handle again.

Stolen vehicle tracking services

In the event your vehicle was stolen:

- ▶ Report the incident to the police.

The police will issue a numbered incident report.

- ▶ Pass this number on to the Mercedes-Benz Response Center along with your password issued to you when you subscribed to the service.

The Response Center will then attempt to covertly contact the vehicle's Tele Aid system. Once the vehicle is located, the Response Center will contact the local law enforcement and you. The vehicle's location will only be provided to law enforcement.

Garage door opener

The built-in remote control is capable of operating up to three separately controlled devices, for example garage door openers, gate openers, or other devices compatible with HomeLink® or some other systems.

You can program the signal transmitter buttons.

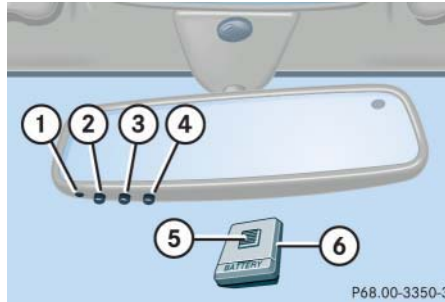

Remote control integrated into the interior rear view mirror

- ① Indicator lamp
- ② ③ ④ Signal transmitter button
- ⑤ Hand-held transmitter button
- ⑥ Hand-held remote control transmitter (not part of the vehicle equipment)

Controls in detail

Useful features

Warning!



Before programming the integrated remote control to a garage door opener or gate operator, make sure people and objects are out of the way of the device to prevent potential harm or damage.

When programming a garage door opener, the door moves up or down. When programming a gate operator, the gate opens or closes.

Do not use the integrated remote control with any garage door opener that lacks safety stop and reverse features as required by U.S. federal safety standards (this includes any garage door opener model manufactured before April 1, 1982).

A garage door that cannot detect an object - signaling the door to stop and reverse - does not meet current U.S. federal safety standards.

Controls in detail

Useful features



Certain types of garage door openers are incompatible with the integrated opener. If you should experience difficulties with programming the transmitter, contact your authorized Mercedes-Benz Center, or call Mercedes-Benz Customer Assistance Center (in the USA only) at 1-800-FOR-MERCEdes, or Customer Service (in Canada) at 1-800-387-0100.



For operation in the USA only: This device complies with Part 15 of the FCC Rules. Operation is subject to the following two conditions:

- (1) This device may not cause harmful interference, and
- (2) this device must accept any interference received, including interference that may cause undesired operation.

Any unauthorized modification to this device could void the user's authority to operate the equipment.

Programming or reprogramming the integrated remote control

Step 1:

- ▶ Switch on ignition.

Step 2:

- ▶ If you have previously programmed an integrated signal transmitter button and wish to retain its programming, proceed to step 3. Otherwise, press and hold the two outer signal transmitter buttons ② and ④ and release them only when the indicator light begins to flash after approximately 20 seconds (do not hold the button for longer than 30 seconds). This procedure erases any previous settings for all three channels and initializes the memory. If you later wish to program a second and/or third hand-held transmitter to the remaining two signal transmitter buttons, do not repeat this step and begin directly with step 3.

Controls in detail

Useful features

Step 3:

- ▶ Hold the end of the hand-held remote control transmitter ⑥ of the device you wish to train approximately 2 to 5 in (5 to 12 cm) away from the surface of the integrated remote control located on the interior rear view mirror, keeping the indicator lamp ① in view.

Step 4:

- ▶ Using both hands, simultaneously press the hand-held transmitter button ⑤ and the desired integrated signal transmitter button (②, ③ or ④). Do not release the buttons until completing step 5.

The indicator lamp ① on the integrated remote control will flash, first slowly and then rapidly.



The indicator lamp ① flashes the first time the signal transmitter button is programmed. If this button has already been programmed, the indicator lamp will only start flashing after 20 seconds.

Step 5:

- ▶ When the indicator lamp ① flashes rapidly, release both buttons.

Step 6:

- ▶ Press and hold the just-trained integrated signal transmitter button and observe the indicator lamp ①.

If the indicator lamp ① stays on constantly, programming is complete and your device should activate when the integrated signal transmitter button is pressed and released.



If the indicator lamp ① flashes rapidly for about two seconds and then turns to a constant light, continue with programming steps 8 through 12 as your garage door opener may be equipped with the “rolling code” feature.

Step 7:

- ▶ To program the remaining two buttons, repeat the steps above starting with step 3.

Controls in detail

Useful features

Rolling code programming

To train a garage door opener (or other rolling code devices) with the rolling code feature, follow these instructions after completing the “Programming” portion (steps 1 through 6) of this text. (A second person may make the following training procedures quicker and easier.)

Step 8:

- ▶ Locate “training” button on the garage door opener motor head unit.

Exact location and color of the button may vary by garage door opener brand. Depending on manufacturer, the “training” button may also be referred to as “learn” or “smart” button. If there is difficulty locating the transmitting button, refer to the garage door opener operator’s manual.

Step 9:

- ▶ Press “training” button on the garage door opener motor head unit.

The “training light” is activated.

You have 30 seconds to initiate the following step.

Step 10:

- ▶ Firmly press, hold for two seconds and release the programmed integrated signal transmitter button (②, ③ or ④).

Step 11:

- ▶ Press, hold for two seconds and release same button a second time to complete the training process.

Some garage door openers (or other rolling code equipped devices) may require you to perform this procedure a third time to complete the training.

Step 12:

- ▶ Confirm the garage door operation by pressing the programmed integrated signal transmitter button (②, ③ or ④).

Step 13:

- ▶ To program the remaining two buttons, repeat the steps above starting with step 3.

Gate operator/Canadian programming

Canadian radio-frequency laws require transmitter signals to “time-out” (or quit) after several seconds of transmission which may not be long enough for the integrated signal transmitter to pick up the signal during programming. Similar to this Canadian law, some U.S. gate operators are designed to “time-out” in the same manner.

If you live in Canada or if you are having difficulties programming a gate operator (regardless of where you live) by using the programming procedures, replace step 4 with the following:

Step 4:

- ▶ Continue to press and hold the integrated signal transmitter button (②, ③ or ④) while you press and re-press (“cycle”) your hand-held remote control transmitter ⑥ every two seconds until the frequency signal has been learned. Upon successful training, the indicator lamp ① will flash slowly and then rapidly after several seconds.
- ▶ Proceed with programming step 5 and step 6 to complete.

Operation of integrated remote control

- ▶ Switch on ignition.
- ▶ Select and press the appropriate integrated signal transmitter button (②, ③ or ④) to activate the remote controlled device.

The integrated remote control transmitter continues to send the signal as long as the button is pressed – up to 20 seconds.

Controls in detail

Useful features

Erasing the integrated remote control memory

- ▶ Switch on ignition.
- ▶ Simultaneously hold down the signal transmitter buttons ② and ④, for approximately 20 seconds, until the indicator lamp ① flashes rapidly. Do not hold for longer than 30 seconds.

The codes of all three channels are erased.



If you sell your vehicle, erase the codes of all three channels.

Reprogramming a single integrated signal transmitter button

To program a device using a signal transmitter button previously trained, follow these steps:

- ▶ Press and hold the desired signal transmitter button (②, ③ or ④). Do not release the button.
- ▶ The indicator lamp will begin to flash after 20 seconds. Without releasing the integrated signal transmitter button, proceed with programming starting with step 3.

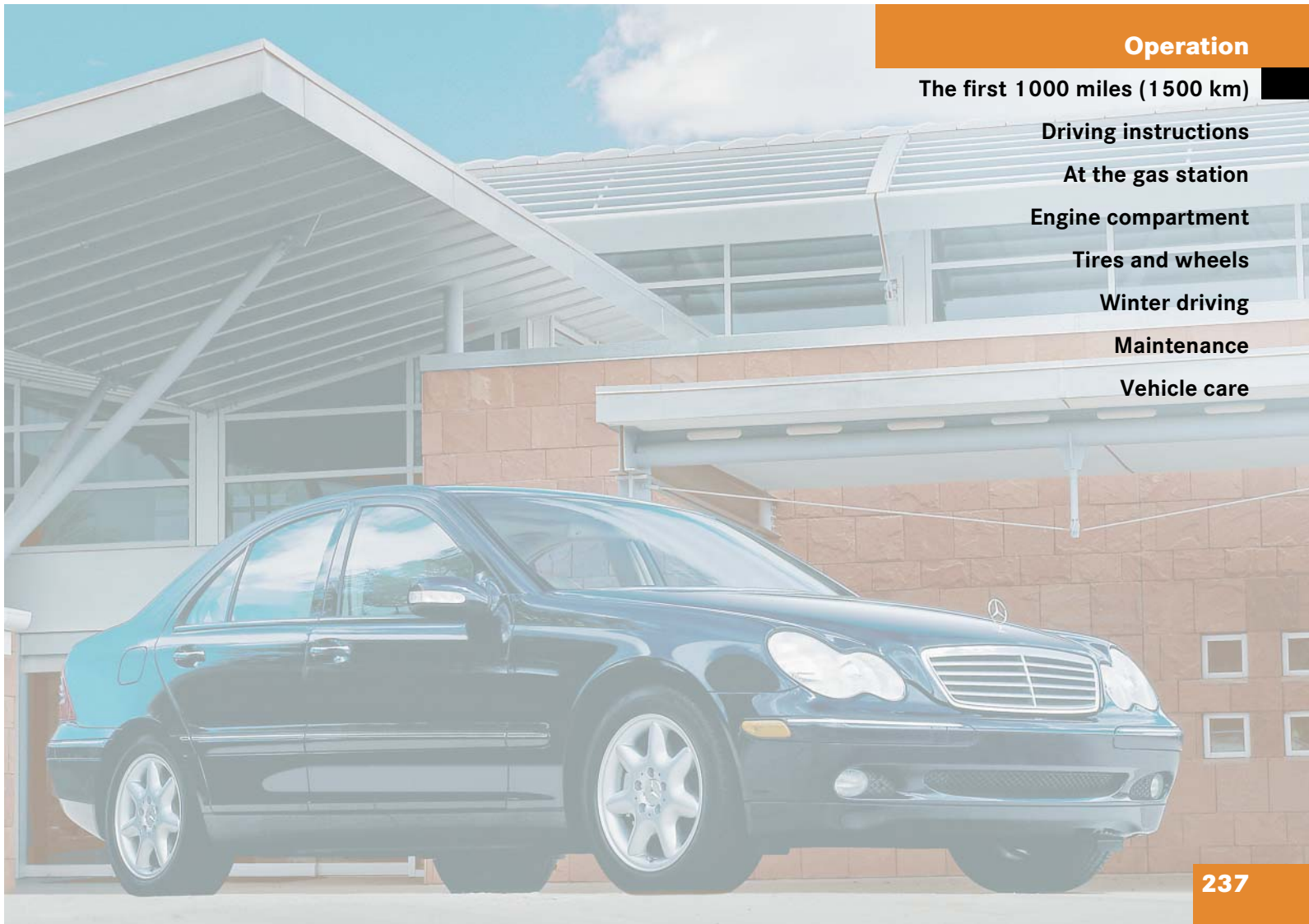

Operation

The first 1000 miles (1500 km)

Driving instructions

At the gas station

Engine compartment

Tires and wheels

Winter driving

Maintenance

Vehicle care

Operation

The first 1 000 miles (1 500 km)

In the “Operation” section you will find detailed information on operating, maintaining and caring for your vehicle.

▼ The first 1 000 miles (1 500 km)

The more cautiously you treat your vehicle during the break-in period, the more satisfied you will be with its performance later on.

- Drive your vehicle during the first 1 000 miles (1 500 km) at varying but moderate vehicle and engine speeds.
- During this period, avoid heavy loads (full throttle driving) and excessive engine speeds (no more than $\frac{2}{3}$ of maximum rpm in each gear).
- Shift gears in a timely manner.
- Avoid accelerating by kick-down.
- Do not attempt to slow the vehicle down by shifting to a lower gear using the gear selector lever.
- Select positions **3**, **2** or **1** only when driving at moderate speeds (for hill driving).

After 1 000 miles (1 500 km) you may gradually increase vehicle and engine speeds to the permissible maximum.



Additional instructions for AMG vehicles:

- During the first 1 000 miles (1 500 km), do not exceed a speed of 85 mph (140 km/h).
- During this period, avoid engine speeds above 4 500 rpm in each gear.

All of the above instructions, as may apply to your vehicle type, also apply when driving the first 1 000 miles (1 500 km) after the engine or the rear differential has been replaced



Always obey applicable speed limits.

▼ **Driving instructions**

Drive sensibly – save fuel

Fuel consumption, to a great extent, depends on driving habits and operating conditions.

To save fuel you should:

- Keep tires at the recommended inflation pressures.
- Remove unnecessary loads.
- Remove roof rack when not in use.
- Allow engine to warm up under low load use.
- Avoid frequent acceleration and deceleration.
- Have all maintenance work performed at the intervals specified in the Service Booklet and as required by the FSS. Contact your authorized Mercedes-Benz Center.

Fuel consumption is also increased by driving in cold weather, in stop-and-go traffic, on short trips and in hilly country.

Drinking and driving

Warning!



Drinking and driving and/or taking drugs and driving are very dangerous combinations. Even a small amount of alcohol or drugs can affect your reflexes, perceptions and judgement.

The possibility of a serious or even fatal accident are greatly increased when you drink or take drugs and drive.

Do not drink or take drugs and drive or allow anyone to drive who has been drinking or taking drugs.

Pedals

Warning!



Keep driver's foot area clear at all times. Objects stored in this area may impair pedal movement.

Power assistance

Warning!



With the engine not running, there is no power assistance for the brake and steering systems. In this case, it is important to keep in mind that a considerably higher degree of effort is necessary to brake and steer the vehicle.

Operation

Driving instructions

Brakes

Warning!



After driving in heavy rain for some time without applying the brakes or through water deep enough to wet brake components, the first braking action may be somewhat reduced and increased pedal pressure may be necessary to obtain expected braking effect. Maintain a safe distance from vehicles in front.

Resting your foot on the brake pedal will cause excessive and premature wear of the brake pads.

It can also result in the brakes overheating, thereby significantly reducing their effectiveness. It may not be possible to stop the vehicle in sufficient time to avoid an accident.

To help prevent brake disk corrosion after driving on wet road surfaces (particularly salted roads), it is advisable to brake the vehicle with considerable force prior to parking. The heat generated serves to dry the brakes.

If your brake system is normally only subject to moderate loads, you should occasionally test the effectiveness of the brakes by applying above-normal braking pressure at higher speeds. This will also enhance the grip of the brake pads.



Be very careful not to endanger other road users when you apply the brakes.

Refer to the description of the Brake Assist System (BAS) (> page 73).

If the parking brake is released and the brake warning lamp in the instrument cluster stays on, the brake fluid level in the reservoir is too low.

Brake pad wear or a leak in the system may be the reason for low brake fluid in the reservoir.

Have the brake system inspected immediately. Contact your authorized Mercedes-Benz Center.

All checks and service work on the brake system should be carried out by qualified technicians only. Contact your authorized Mercedes-Benz Center.

Only install brake pads and brake fluid recommended by Mercedes-Benz.

Warning!



If other than recommended brake pads are installed, or other than recommended brake fluid is used, the braking properties of the vehicle can be degraded to an extent that safe braking is substantially impaired. This could result in an accident.



When driving down long and steep grades, relieve the load on the brakes by shifting into a lower gear to use the engine's braking power. This helps prevent overheating of the brakes and reduces brake pad wear.

After hard braking, it is advisable to drive on for some time, rather than immediately parking, so that the air stream will cool down the brakes faster.

Driving off

Apply the brakes to test them briefly after driving off. Perform this procedure only when the road is clear of other traffic.

Warm up the engine smoothly. Do not place full load on the engine until the operating temperature has been reached.

When starting off on a slippery surface, do not allow a drive wheel to spin for an extended period with the ESP switched off. Doing so may cause serious damage to the drive train which is not covered by the Mercedes-Benz Limited Warranty.



Simultaneously depressing the accelerator pedal and applying the brake reduces engine performance and causes premature brake and drivetrain wear.

Parking



Set the parking brake whenever parking or leaving the vehicle. In addition, move gear selector lever to position **P** (manual transmission: first or reverse gear).

When parking on hills, always turn front wheels towards the road curb.

Operation

Driving instructions

Warning!



Do not park this vehicle in areas where combustible materials such as grass, hay or leaves can come into contact with the hot exhaust system, as these materials could be ignited and cause a vehicle fire.

To reduce the risk of personal injury as a result of vehicle movement, before turning off the engine and leaving the vehicle always:

- Keep right foot on brake pedal.
- Firmly depress parking brake pedal.
- Move the gear selector lever to position **P** (manual transmission: first or reverse gear).
- Slowly release brake pedal.
- When parked on an incline, turn front wheels towards the road curb.
- Turn the SmartKey to starter switch position **0** and remove.
- Take the SmartKey with you and lock vehicle when leaving.

Operation

Driving instructions

Tires

Warning!



If you feel a sudden significant vibration or ride disturbance, or you suspect that possible damage to your vehicle has occurred, you should turn on the hazard warning flashers, carefully slow down, and drive with caution to an area which is a safe distance from the road.

Inspect the tires and the vehicle underbody for possible damage. If the vehicle or tires appear unsafe, have it towed to the nearest Mercedes-Benz Center or tire dealer for repairs.

Tread wear indicators (TWI) are required by law. These indicators are located in six places on the tread circumference and become visible at a tread depth of approximately $\frac{1}{16}$ in (1.6 mm), at which point the tire is considered worn and should be replaced.

The tread wear indicator appears as a solid band across the tread.

Warning!



Although the applicable federal motor vehicle safety laws consider a tire to be worn when the tread wear indicators (TWI) become visible at approximately $\frac{1}{16}$ in (1.6 mm), we recommend that you do not allow your tires to wear down to that level. As tread depth approaches $\frac{1}{8}$ in (3 mm), the adhesion properties on a wet road are sharply reduced.

Depending upon the weather and/or road surface (conditions), the tire traction varies widely.

Specified tire pressures must be maintained. This applies particularly if the tires are subjected to high loads (e.g. high speeds, heavy loads, high ambient temperatures).

Warning!



Do not drive with a flat tire. A flat tire affects the ability to steer or brake the vehicle. You may lose control of the vehicle. Continued driving with a flat tire or driving at high speed with a flat tire will cause excessive heat build-up and possibly a fire.

Hydroplaning

Depending on the depth of the water layer on the road, hydroplaning may occur, even at low speeds and with new tires. Reduce vehicle speed, avoid track grooves in the road and apply brakes cautiously in the rain.

Tire traction

The safe speed on a wet, snow covered or icy road is always lower than on a dry road.

You should pay particular attention to the condition of the road whenever the outside temperatures are close to the freezing point.

Warning!



If ice has formed on the road, tire traction will be substantially reduced. Under such weather conditions, drive, steer and brake with extreme caution.

Mercedes-Benz recommends M+S rated radial-ply tires with a minimum tread depth of approximately $\frac{1}{6}$ in (4 mm) on all four wheels for the winter season to ensure normal balanced handling characteristics. On packed snow, they can reduce your stopping distance compared to summer tires. Stopping distance, however, is still

considerably greater than when the road is not covered with snow or ice. Exercise appropriate caution.



Avoid spinning of one drive wheel. This may cause serious damage to the drive train which is not covered by the Mercedes-Benz Limited Warranty.

Tire speed rating

Regardless of the tire speed rating, local speed limits should be obeyed. Use prudent driving speeds appropriate to prevailing conditions.

Warning!



Even when permitted by law, never operate a vehicle at speeds greater than the maximum speed rating of the tires.

Exceeding the maximum speed for which tires are rated can lead to sudden tire failure, causing loss of vehicle control and possibly resulting in an accident and/or personal injury and possible death, for you and for others.

Operation

Driving instructions

C 240, C 240 4MATIC, C 320, and C 320 4MATIC

Your vehicle is factory equipped with “H”-rated tires, which have a speed rating of 130 mph (210 km/h).

An electronic speed limiter prevents your vehicle from exceeding a speed of 130 mph (210 km/h).

C 230 Kompressor Sport, and C 320 Sport

Your vehicle is factory equipped with “W”-rated tires, which have a speed rating of 168 mph (270 km/h) or with “Y”-rated tires, which have a speed rating of 186 mph (300 km/h).

An electronic speed limiter prevents your vehicle from exceeding a speed of 130 mph (210 km/h).

C 32 AMG

Your vehicle is factory equipped with “Y”-rated tires, which have a speed rating of 186 mph (300 km/h).

An electronic speed limiter prevents your vehicle from exceeding a speed of 155 mph (250 km/h).



For information on tire speed rating for winter tires, see “Winter tires” (> page 263).

Winter driving instructions

The most important rule for slippery or icy roads is to drive sensibly and to avoid abrupt acceleration, braking and steering maneuvers. Do not use the cruise control system under such conditions.

When the vehicle is in danger of skidding, move gear selector lever to position **N** or in case of manual transmission declutch. Try to keep the vehicle under control by corrective steering action.



For information on driving with snow chains, see “Snow chains” (> page 264).

Warning!



On slippery road surfaces, never downshift in order to obtain braking action. This could result in drive wheel slip and reduced vehicle control. Your vehicle’s ABS will not prevent this type of control loss.

Road salts and chemicals can adversely affect braking efficiency. Increased pedal force may become necessary to produce the normal braking effect.

Depressing the brake pedal periodically when traveling at length on salt-strewn roads can bring road-salt-impaired braking efficiency back to normal.

If the vehicle is parked after being driven on salt-treated roads, the braking efficiency should be tested as soon as possible after driving is resumed.

Warning!



Make sure not to endanger any other road users when carrying out these braking maneuvers.

Warning!



If the vehicle becomes stuck in snow, make sure snow is kept clear of the exhaust pipe and from around the vehicle with the engine running. Otherwise, deadly carbon monoxide (CO) gases may enter vehicle interior resulting in unconsciousness and death.

To assure sufficient fresh air ventilation, open a window slightly on the side of the vehicle not facing the wind

Warning!



The outside temperature indicator is not designed to serve as an ice-warning device and is therefore unsuitable for that purpose. Indicated temperatures just above the freezing point do not guarantee that the road surface is free of ice.

For more information, see “Winter driving” (▷ page 263).

Standing water



Do not drive through flooded areas or water of unknown depth. Before driving through water, determine its depth. Never accelerate before driving into water. The bow wave could force water into the engine and auxiliary equipment, thus damaging them.

If you must drive through standing water, drive slowly to prevent water from entering the passenger compartment or the engine compartment. Water in these areas could cause damage to electrical components or wiring of the engine or transmission, or could result in water being ingested by the engine through the air intake causing severe internal engine damage. Any such damage is not covered by the Mercedes-Benz Limited Warranty.

Operation

Driving instructions

Passenger compartment

Warning!



Always fasten items being carried as securely as possible.

In an accident, during hard braking or sudden maneuvers, loose items will be thrown around inside the vehicle, and cause injury to vehicle occupants unless the items are securely fastened in the vehicle.

The trunk is the preferred place to carry objects.

Driving abroad

Abroad, there is an extensive Mercedes-Benz service network at your disposal. If you plan to drive into areas which are not listed in the index of your Mercedes-Benz Center directory, you should request pertinent information from your authorized Mercedes-Benz Center.

Control and operation of radio transmitters

COMAND*, radio and telephone*

Warning!



Please do not forget that your primary responsibility is to drive the vehicle safely. Only operate the COMAND (Cockpit Management and Data System), radio or telephone¹ if road, weather and traffic conditions permit.

Bear in mind that at a speed of just 30 mph (approximately 50 km/h), your vehicle is covering a distance of approximately 44 feet (approximately 13.5 m) every second.

¹ Observe all legal requirements

Telephones* and two-way radios

Warning!



Never operate radio transmitters equipped with a built-in or attached antenna (i.e. without being connected to an external antenna) from inside the vehicle while the engine is running. Doing so could lead to a malfunction of the vehicle's electronic system, possibly resulting in an accident and personal injury.

Radio transmitters, such as a portable telephone or a citizens band unit should only be used inside the vehicle if they are connected to an antenna that is installed on the outside of the vehicle.

Refer to the radio transmitter operation instructions regarding use of an external antenna.

Catalytic converter

Your Mercedes-Benz is equipped with monolithic-type catalytic converters, an important element in conjunction with the oxygen sensors to achieve substantial control of the pollutants in the exhaust emissions. Keep your vehicle in proper operating condition by following our recommended maintenance instructions as outlined in your Service Booklet.



To prevent damage to the catalytic converters, only use premium unleaded gasoline in this vehicle.

Any noticeable irregularities in engine operation should be repaired promptly. Otherwise, excessive unburned fuel may reach the catalytic converter, causing it to overheat and start a fire.

Warning!



As with any vehicle, do not idle, park or operate this vehicle in areas where combustible materials such as grass, hay or leaves can come into contact with the hot exhaust system, as these materials could be ignited and cause a vehicle fire.

Emission control

Certain systems of the engine serve to keep the toxic components of the exhaust gases within permissible limits required by law.

These systems, of course, will function properly only when maintained strictly according to factory specifications. Any adjustments on the engine should, therefore, be carried out only by qualified Mercedes-Benz Center authorized technicians. Engine adjustments should not be altered in any way. Moreover, the specified service jobs must be carried out regularly according to Mercedes-Benz servicing requirements. For details refer to the Service Booklet.

Operation

Driving instructions

Warning!



Inhalation of exhaust gas is hazardous to your health. All exhaust gas contains carbon monoxide, and inhaling it can cause unconsciousness and lead to death.

Do not run the engine in confined areas (such as a garage) which are not properly ventilated. If you think that exhaust gas fumes are entering the vehicle while driving, have the cause determined and corrected immediately. If you must drive under these conditions, drive only with at least one window fully open at all times.

Coolant temperature

During severe operating conditions and stop-and-go city traffic, the coolant temperature may rise close to approximately 248°F (120°C).

The engine should not be operated with the coolant temperature over 248°F (120°C). Doing so may cause serious engine damage which is not covered by the Mercedes-Benz Limited Warranty.

Warning!



- Driving when your engine is badly overheated can cause some fluids, which may have leaked into the engine compartment, to catch fire. You could be seriously burned.
- Steam from an overheated engine can cause serious burns and can occur just by opening the hood. Stay away from the engine if you see or hear steam coming from it.

Turn off the engine, get out of the vehicle and do not stand near the vehicle until the engine has cooled down.

▼ At the gas station

Refueling

Warning!



Gasoline is highly flammable and poisonous. It burns violently and can cause serious injury. Whenever you are around gasoline, avoid inhaling fumes and skin contact, extinguish all smoking materials. Never allow sparks, flame or smoking materials near gasoline!

Warning!



Flexible Fuel Vehicles only (identified by a label reading **Premium gasoline or E85 only!** on fuel filler flap):

Ethanol fuel (E85) and its vapors are highly flammable, poisonous and burn easily. Ethanol fuel can cause serious injuries if ignited or if you come into contact with it or inhale fumes of it. Avoid inhalation of Ethanol fumes and skin contact with Ethanol. Extinguish all open flames before fueling. Never smoke or create sparks close to Ethanol.

Operation

At the gas station

The fuel filler flap is located on the right-hand side of the vehicle towards the rear. Locking/unlocking the vehicle with the SmartKey automatically locks/unlocks the fuel filler flap.

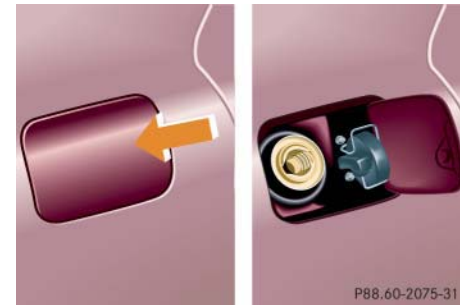

- ▶ Turn the engine off by turning the SmartKey to position **0**.
- ▶ Remove the SmartKey from the starter switch. ▷▷

Operation

At the gas station

- ▷▷▶ Open fuel filler flap by pushing at the point indicated by the arrow.
The fuel filler flap springs open.
- ▶ Turn fuel cap to the left and hold on to it until possible pressure is released.
- ▶ Take off cap and set it in the recess on fuel filler flap.
To prevent fuel vapors from escaping into open air, fully insert filler nozzle unit.
- ▶ Only fill your tank until the filler nozzle unit cuts out – do not top up or overfill.

Warning!



Overfilling of the fuel tank may create pressure in the system which could cause a gas discharge. This could cause the gas to spray back out when removing the fuel pump nozzle, which could cause personal injury.

- ▶ Replace fuel cap by turning it to the right.
You will hear when fuel cap is tightened.
- ▶ Close fuel filler flap.



Only use premium unleaded gasoline with a minimum Posted Octane Rating of 91 (average of 96 RON/86 MON). Information on gasoline quality can normally be found on the fuel pump.

More information on gasoline can be found in the Factory Approved Service Products pamphlet.

Flexible Fuel Vehicles are identified by a label reading **Premium gasoline or E85 only!** on fuel filler flap.

For more information, see “Flexible Fuel Vehicles” (▷ page 354).



Leaving the engine running and the fuel cap open can cause the **CHECK ENGINE** malfunction indicator lamp to illuminate.

For more information, see “Practical hints” (▷ page 276).

Check regularly and before a long trip

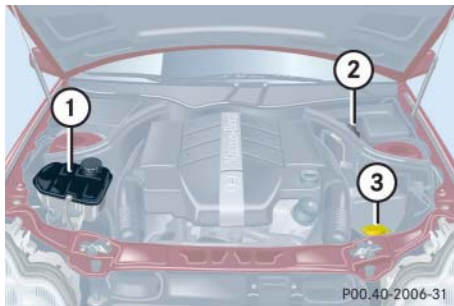

- ① Coolant level
For more information on coolant, see “Coolant level” (▷ page 257).
- ② Brake fluid (fuse box cover removed)
Removing fuse box cover
(▷ page 333).
- ③ Windshield washer and headlamp cleaning system*
For more information on filling up the washer reservoir, see “Windshield washer system and headlamp cleaning system*” (▷ page 259).



If you find that the brake fluid in the brake fluid reservoir has fallen to the minimum mark or below, have the brake system checked for brake pad thickness and leaks immediately. Notify an authorized Mercedes-Benz Center immediately. Do not add brake fluid as this will not solve the problem. For more information, see “Practical hints” (▷ page 275).

Engine oil level

For more information on engine oil level, see “Engine oil” (▷ page 253).

Opening hood (▷ page 252).

Vehicle lighting

Check function and cleanliness. For more information on replacing light bulbs, see “Replacing bulbs” (▷ page 310).

Exterior lamp switch (▷ page 102).

Tire inflation pressure

More information on tire inflation pressure (▷ page 261).

Operation

Engine compartment

▼ Engine compartment

Hood

Warning!



Do not pull the release lever while the vehicle is in motion. Otherwise the hood could be forced open by passing air flow.

Opening

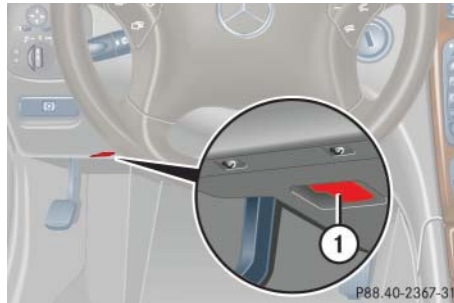

① Hood release

- ▶ Pull lever ① downwards.

The hood is unlocked and handle ② will extend out of the radiator grille.



To avoid damage to the windshield wipers or hood, never open the hood if the wiper arms are folded forward away from the windshield.



② Handle for opening the hood

- ▶ Pull handle ② to its stop out of radiator grille.
- ▶ Pull up on the hood (do not pull up on the handle) and then release it.

The hood will be automatically held open at shoulder height by gas-filled struts.

Warning!



To help prevent personal injury, stay clear of moving parts when the hood is open and the engine is running. Make sure the hood is properly closed before driving. When closing the hood, use extreme caution not to catch hands or fingers.

The radiator fan may continue to run for approximately 30 seconds or even restart after the engine has been turned off. Stay clear of fan blades.

Warning!



If you see flames or smoke coming from the engine compartment, or if the coolant temperature gauge indicates that the engine is overheated, do not open the hood. Move away from vehicle and do not open the hood until the engine has cooled. If necessary, call the fire department.

Warning!



The engine is equipped with a transistorized ignition system. Because of the high voltage it is dangerous to touch any components (ignition coils, spark plug sockets, diagnostic socket) of the ignition system

- with the engine running
- while starting the engine
- if ignition is “on” and the engine is turned manually

Closing

Warning!



Be careful that you do not close the hood on anyone.

- ▶ Let the hood drop from a height of approximately 1 ft (30 cm).
The hood will lock audibly.
- ▶ Check to make sure the hood is fully closed.

If you can raise the hood at a point above the headlamps, then it is not properly closed. Open it again and let it drop with somewhat greater force.

Operation

Engine compartment

Engine oil

The amount of oil your engine needs will depend on a number of factors, including driving style. Higher oil consumption can occur when

- the vehicle is new
- the vehicle is driven frequently at higher engine speeds

Engine oil consumption checks should only be made after the vehicle break-in period.



Do not use any special lubricant additives, as these may damage the drive assemblies. Using special additives not approved by Mercedes-Benz will restrict your warranty entitlement.

More information on this subject is available at any Mercedes-Benz Center.

Operation

Engine compartment

Checking engine oil level with the control system



When checking the oil level the vehicle must

- be parked on level ground
- be at normal operating temperature
- have been stationary for at least five minutes with the engine turned off

To check the engine oil level via the multifunction display, do the following:

- ▶ Turn the SmartKey in the starter switch to position **2**.

The standard display (▷ page 113) should appear in the multifunction display.

- ▶ Press button  or  on the steering wheel until the following message is seen in the multifunction display:

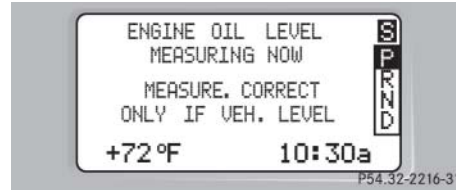

```
ENGINE OIL LEVEL  
MEASURING NOW  
MEASURE. CORRECT  
ONLY IF VEH. LEVEL
```



One of the following messages will subsequently appear in the indicator:

- ENGINE OIL LEVEL OK
- ADD 1.0 Qt. TO REACH MAX. OIL LEVEL!
(Canada: 1.0 LITER)
- ADD 1.5 Qts. TO REACH MAX. OIL LEVEL!
(Canada: 1.5 LITERS)
- ADD 2.0 Qts. TO REACH MAX. OIL LEVEL!
(Canada: 2.0 LITERS)



If you want to interrupt the checking procedure, press the  or  button on the multifunction steering wheel.

- ▶ If necessary, add engine oil.

For adding engine oil see (▷ page 255).

More information on engine oil can be found in the “Technical data” section (▷ page 349) and (▷ page 352).

Other display messages

If the SmartKey is not turned to position **2** in the starter switch, the following message will appear:

```
FOR ENGINE OIL LEVEL  
SWITCH ON IGNITION!
```

- ▶ Switch on the ignition.

If you see the message:

OBSERVE WAITING PERIOD

- ▶ If engine is at normal operating temperature, wait five minutes before repeating check procedure.
- ▶ If engine is not yet at normal operating temperature, wait 30 minutes before repeating check procedure.

If you see the message:

ENGINE OIL LEVEL
NOT WHEN ENGINE ON!

- ▶ Turn off the engine.
- ▶ If the engine is at normal operating temperature, wait five minutes before checking oil.
- ▶ If the engine is not yet at normal operating temperature, you must wait 30 minutes before checking oil.

If there is excess engine oil with the engine at normal operating temperature, the following message will appear:

ENGINE OIL LEVEL
REDUCE OIL LEVEL

- ▶ Have excess oil siphoned or drained off. Contact your authorized Mercedes-Benz Center.



Excess oil must be siphoned or drained off. It could cause damage to the engine and catalytic converter not covered by the Mercedes-Benz Limited Warranty.

More information on messages in the display concerning engine oil can be found in the “Practical hints” section (▷ page 291).

Adding engine oil



Only use approved engine oils. For a listing of approved engine oils, refer to the Factory Approved Service Products pamphlet in your vehicle literature portfolio.

In addition, check the oil filler cap for important information pertaining to the engine oil needing to meet a specific Mercedes-Benz specification (e.g. MB 229.5). If such information is printed on the oil filler cap, only use an engine oil from the list of approved engine oils in the Factory Approved Service Products pamphlet that meets the specification indicated on the oil filler cap. Using engine oils of other specification may cause the FSS to incorrectly determine the next service interval and will result in engine damage not covered by the Mercedes-Benz Limited Warranty.

Operation

Engine compartment

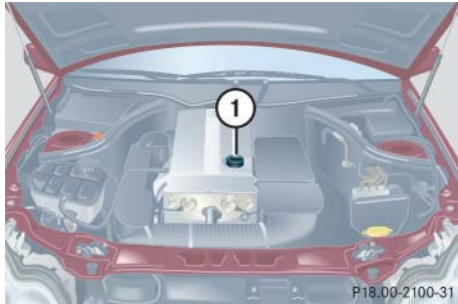

C 230 Kompressor Sport

- ① Filler cap
- ▶ Unscrew filler cap ① from filler neck.
- ▶ Add engine oil as required. Be careful not to overfill with oil.

Be careful not to spill any oil when adding. Avoid environmental damage caused by oil entering the ground or water.

! Excess oil must be siphoned or drained off. It could cause damage to the engine and catalytic converter not covered by the Mercedes-Benz Limited Warranty.

- ▶ Screw filler cap ① back on filler neck.



C 240, and C 320 (all models), C 32 AMG

- ① Filler cap
- ▶ Unscrew filler cap ① from filler neck.
- ▶ Add engine oil as required. Be careful not to overfill with oil.

Be careful not to spill any oil when adding. Avoid environmental damage caused by oil entering the ground or water.

! Excess oil must be siphoned or drained off. It could cause damage to the engine and catalytic converter not covered by the Mercedes-Benz Limited Warranty.

- ▶ Screw filler cap ① back on filler neck.

More information on engine oil can be found in the “Technical data” section (▷ page 349) and (▷ page 352).

Transmission fluid level

The transmission fluid level does not need to be checked. If you notice transmission fluid loss or gear shifting malfunctions, have an authorized Mercedes-Benz Center check the transmission.

Coolant level

The engine coolant is a mixture of water and anticorrosion/antifreeze. To check the coolant level, the vehicle must be parked on level ground and the engine must be cool.

The coolant expansion tank is located on the passenger side of the engine compartment.

Warning!



In order to avoid any possibly serious burns:

- Use extreme caution when opening the hood if there are any signs of steam or coolant leaking from the cooling system, or if the coolant temperature gauge indicates that the coolant is overheated.
- Do not remove pressure cap on coolant reservoir if engine temperature is above 194°F (90°C). Allow engine to cool down before removing cap. The coolant reservoir contains hot fluid and is under pressure.

- Using a rag, slowly open the cap approximately $\frac{1}{2}$ turn to relieve excess pressure. If opened immediately, scalding hot fluid and steam will be blown out under pressure.
- Do not spill antifreeze on hot engine parts. Antifreeze contains ethylene glycol which may burn if it comes into contact with hot engine parts.



① Coolant expansion tank

- ▶ Using a rag, turn cap slowly approximately one half turn to the left to release any excess pressure.
- ▶ Continue turning the cap to the left and remove it.

The coolant level is correct if the level

- for cold coolant: reaches the black top part of the reservoir
- for warm coolant: is approx. 0.6 in (1.5 cm) higher

- ▶ Add coolant as required.
- ▶ Replace and tighten cap.

For more information on coolant, see “Coolants” (▷ page 356).

Operation

Engine compartment

Battery

Your vehicle's battery is located in the engine compartment (▷ page 323).

The battery should always be sufficiently charged in order to achieve its rated service life. Refer to Service Booklet for battery maintenance intervals.

If you use your vehicle mostly for short-distance trips, you will need to have the battery charge checked more frequently.

When replacing the battery, always use batteries approved by Mercedes-Benz.

If you do not intend to operate your vehicle for an extended period of time, consult an authorized Mercedes-Benz Center about steps you need to observe.



Observe all safety instructions and precautions when handling automotive batteries.



Risk of explosion



Keep flames or sparks away from battery. Do not smoke.



Battery acid is caustic. Do not allow it to come into contact with skin, eyes or clothing.

In case it does, immediately flush affected area with clear water and seek medical help if necessary.



Wear eye protection.



Keep children away.



Follow the instructions in this Operator's Manual.

Batteries contain materials that can harm the environment if disposed of improperly. Recycling of batteries is the preferred method of disposal. Many states require sellers of batteries to accept old batteries for recycling.

Windshield washer system and headlamp cleaning system*

The windshield washer reservoir is located in the engine compartment.

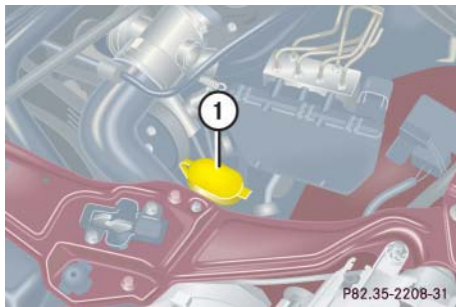

① Washer fluid reservoir

Fluid for the windshield washer system and the headlamp cleaning system* is supplied from the windshield washer reservoir. It has a capacity of:

- 3.2 US qt (3.0 l) in vehicles without headlamp cleaning system*
- 6.4 US qt (6.0 l) in vehicles with headlamp cleaning system*

During all seasons, add MB Windshield Washer Concentrate “S” to water. Premix the windshield washer fluid in a suitable container.

- ▶ Refill the reservoir with MB Windshield Washer Concentrate and water (or commercially available premixed windshield washer solvent/antifreeze, depending on ambient temperatures).

Always use washer solvent/antifreeze where temperatures may fall below the freezing point. Failure to do so could result in damage to the washer system/reservoir.



Only use washer fluid which is suitable for plastic lenses. Improper washer fluid can damage the plastic lenses of the headlamps.

Operation

Engine compartment

Warning!



Washer solvent/antifreeze is highly flammable. Do not spill washer solvent/antifreeze on hot engine parts, because it may ignite and burn. You could be seriously burned.

For more information, see “Windshield washer and headlamp cleaning* system” (▷ page 358).

Operation

Tires and wheels

▼ Tires and wheels

See your authorized Mercedes-Benz Center for information on tested and recommended rims and tires for summer and winter operation. They can also offer advice concerning tire service and purchase.

Warning!



Replace rims or tires with the same designation, manufacturer and type as shown on the original part. See your authorized Mercedes-Benz Center for further information. If incorrectly sized rims and tires are mounted:

- The wheel brakes or suspension components can be damaged.
- The correct operating clearance of the wheels and the tires are no longer guaranteed.

Warning!



Worn, old tires can cause accidents. If the tire tread is badly worn, or if the tires have sustained damage, replace them.

When replacing rims, only use genuine Mercedes-Benz wheel bolts specified for the particular rim type. Failure to do so can result in the bolts loosening and possibly an accident.

Retreaded tires are not tested or recommended by Mercedes-Benz, since previous damage cannot always be recognized on retreads. Mercedes-Benz can therefore not assure the operating safety of the vehicle when such tires are used.

See your authorized Mercedes-Benz Center for information on tested and recommended rims and tires for summer and winter operation.

Important guidelines

- Only use sets of tires and rims of the same type and make.
- Tires must be of the correct size for the rim.
- Break in new tires for approximately 60 miles (100 km) at moderate speeds.
- Regularly check the tires and rims for damage. Dented or bent rims can cause tire pressure loss and damage to the tire beads.
- If vehicle is heavily loaded, check tire pressure and correct as required.
- Do not allow your tires to wear down too far. Adhesion properties on wet roads are sharply reduced at tread depths under $\frac{1}{8}$ in (3 mm).
- When replacing individual tires, you should mount new tires on the front wheels first (on vehicles with same-sized wheels all around).

Life of tire

The service life of a tire is dependent upon varying factors including but not limited to:

- Driving style
- Tire pressure
- Distance driven

Warning!



Tires and spare tire should be replaced after six years, regardless of the remaining tread.



Keep unmounted tires in a cool, dry place with as little exposure to light as possible. Protect tires from contact with oil, grease and gasoline.

Direction of rotation

Unidirectional tires offer added advantages, such as better hydroplaning performance. To benefit, however, you must make sure the tires rotate in the direction specified.

An arrow on the sidewall indicates the intended direction of tire rotation.

Checking tire inflation pressure

Warning!



If the tire pressure drops repeatedly:

- Check the tires for punctures from foreign objects.
- Check to see whether air is leaking from the valves or from around the rim.

Correct the tire pressure only when tires are cold.

Regularly check your tire pressure at intervals of no more than 14 days.

If the tires are warm you should only correct the tire pressure if it is too low for current operating conditions.

A table on the fuel filler flap lists the specified tire inflation pressures for warm and cold tires as well as for various operating conditions.



The pressures listed for light loads are minimum values offering high driving comfort.

Increased inflation pressures listed for heavier loads may also be used for light loads. These higher pressures produce favorable handling characteristics. The ride of the vehicle, however, will be somewhat harder. Never exceed the max. values or inflate tires below the min. values listed in the fuel filler flap.

Operation

Tires and wheels

Tire pressure changes by approx. 1.5 psi (0.1 bar) per 18°F (10°C) of air temperature change. Keep this in mind when checking tire pressure where the temperature is different from the outside temperature.

Tire temperature and tire pressure are also increased while driving, depending on the driving speed and the tire load.

Check the spare tire periodically for condition and inflation. Spare tires will age and become worn over time even if never used, and thus should be inspected and replaced when necessary.

Warning!



Follow recommended inflation pressures.

Do not overinflate tires. Overinflated tires can result in sudden deflation (blowout) because they are more likely to become punctured or damaged by road debris, potholes, etc.

Do not underinflate tires. Underinflated tires wear unevenly, adversely affect handling and fuel economy, and are more likely to fail from being overheated.

Do not overload the tires by exceeding the specified vehicle capacity weight (as indicated by the label on the pillar in the driver's door opening). Overloading the tires can overheat them, possibly causing a blowout.

Rotating wheels

Warning!



Rotate front and rear wheels only if they are of the same size.

On vehicles with the same wheel size all around, wheels can be rotated every 3000 to 6000 miles (5000 to 10000 km), or sooner if necessary, according to the degree of tire wear. The same direction of tire rotation must be retained.

Rotate the wheels before the characteristic tire wear pattern becomes visible (shoulder wear on front wheels and tread center wear on rear wheels).

Thoroughly clean the inner side of the wheels after each rotation. Check and ensure proper tire inflation pressure.

Warning!



Have the tightening torque checked after changing a wheel. Wheels could become loose if not tightened with a torque of 80 lb-ft (110 Nm).

Only use genuine Mercedes-Benz wheel bolts specified for your vehicle's rims.

▼ Winter driving

Before the onset of winter, have your vehicle winterized at an authorized Mercedes-Benz Center. This service includes:

- Check of anticorrosion and antifreeze concentration.
- Addition of cleaning concentrate to the water of the windshield and headlamp cleaning system. Add MB Concentrate "S" to a premixed windshield washer solvent/antifreeze which is formulated for below freezing temperatures (▷ page 358).
- Battery test. Battery capacity drops with decreasing ambient temperature. A well charged battery helps to ensure that the engine can be started, even at low ambient temperatures.
- Tire change. Mercedes-Benz recommends M+S rated radial-ply tires with a minimum tread depth of approximately $\frac{1}{6}$ in (4 mm) on all four wheels for the winter season.

Winter tires

Always use winter tires at temperatures below 45°F (7°C) and whenever wintry road conditions prevail. Use of winter tires is the only way to achieve the maximum effectiveness of the ABS, ESP and 4MATIC in winter operation.

For safe handling, ensure that all mounted winter tires are of the same make and have the same tread design.

Warning!



Winter tires with a tread depth under $\frac{1}{6}$ in (4 mm) must be replaced. They are no longer suitable for winter operation.

Always observe the speed rating of the winter tires installed on your vehicle. If the maximum speed for which your tires are rated is below the speed rating of your vehicle, you must place a notice to this effect where it will be seen by the driver. Such notices are available from your tire dealer or from any authorized Mercedes-Benz Center.

Warning!



If you use your spare tire when winter tires are fitted on the other wheels, be aware that the difference in tire characteristics may very well impair turning stability and that overall driving stability may be reduced. Adapt your driving style accordingly.

Have the spare tire replaced with a winter tire at the nearest authorized Mercedes-Benz Center.

Operation

Winter driving

Block heater (Canada only)

The engine is equipped with a block heater.

The electrical cable may be installed at your authorized Mercedes-Benz Center.

Snow chains

Snow chains should only be driven on snow-covered roads at speeds not to exceed 30 mph (50 km/h). Remove chains as soon as possible when driving on roads without snow.



When driving with snow chains, you may wish to deactivate the ESP (▷ page 74) before setting the vehicle in motion. This will improve the vehicle's traction.

Please observe the following guidelines when using snow chains:

- Use of snow chains is not permissible with all wheel/tire combinations.
- Snow chains should only be used on the rear wheels. Follow the manufacturer's mounting instructions.

- Only use snow chains that are approved by Mercedes-Benz. Your authorized Mercedes-Benz Center will be glad to advise you on this subject.
- Use of snow chains may be prohibited depending on location. Always check local and state laws before installing snow chains.



Even on vehicles with all-wheel-drive use snow chains on rear tires only.

Use of snow chains is not permissible with tire sizes:

- 225/45 R17 91H M+S
- 225/45 R17 91W
- 245/40 R17 91W
- 245/40 R17 91Y
- 245/40 ZR17 91Y
- T 125/90 R16 98M
- T 125/80 R17 99M

▼ **Maintenance**

We strongly recommend that you have your vehicle serviced by your authorized Mercedes-Benz Center, in accordance with the Service Booklet at the times called for by the FSS (Flexible Service System).

Failure to have the vehicle maintained in accordance with the Service Booklet at the designated times/mileage called for by the FSS may result in vehicle damage not covered by the Mercedes-Benz Limited Warranty.



FSS will notify you when your next service is due.

Approximately one month before your next service is due, one of the following messages will appear in the multifunction display while you are driving or when you switch on the ignition (example service A):

SERVICE A IN XX DAYS
 SERVICE A IN XX MILES (KM)
 SERVICE A DUE NOW!



The type of service due is indicated in the multifunction display:

-  Minor service (A)
-  Major service (B)



The interval between services depends on your driving habits. A gentle driving style, moderate engine speeds and the avoidance of short-distance trips will lengthen the interval between services.

Clearing the service indicator

The service indicator is automatically cleared

- after ten seconds when you switch on the ignition or when reaching the service threshold while driving
- after 30 seconds, once the suggested service term has passed

You can also clear it yourself.

- ▶ Press the reset button on the instrument cluster (▷ page 22).

Service term exceeded

If you have exceeded the suggested service term, you will see the following message in the multifunction display:

SERVICE A EXCEEDED BY XX DAYS
 SERVICE A EXCEEDED BY XX MI (KM)

An acoustic signal will also sound.

Operation



Maintenance

The Mercedes-Benz Center will reset the service indicator following a completed service.

Calling up the service indicator

- ▶ Switch on ignition.

The standard display of the control system appears (▷ page 113).

- ▶ Press button  or  on the multifunction steering wheel until the FSS indicator appears in the multifunction display.



If the battery is disconnected, the days of disconnection will not be included in the count shown by the service indicator. To arrive at the true service deadline, you will need to subtract these days from the days shown in the service indicator.



Do not confuse the service indicator with the engine oil level indicator .

Resetting the service indicator

In the event that the service on your vehicle is not carried out by an authorized Mercedes-Benz Center, you can reset the service indicator yourself.

- ▶ Switch on ignition.

The standard display of the control system appears (▷ page 113).

- ▶ Press button  or  on the multifunction steering wheel until the FSS indicator appears in the multifunction display.

- ▶ Press reset button for about three seconds.

This message appears in the multifunction display:

SERVICE INTERVAL?
RESET WITH R BUTTON FOR 3 SEC.

- ▶ To confirm, press reset button until you hear a signal.

The service indicator now displays the reset interval.



If the service indicator was inadvertently reset, have a Mercedes-Benz Center correct it.

Only reset if the proper service has been performed. Resetting the system without performing proper service as called for by the FSS will cause the FSS to incorrectly determine the next service interval which will result in engine damage not covered by the Mercedes-Benz Limited Warranty.

▼ Vehicle care

Cleaning and care of the vehicle

Warning!



Many cleaning products can be hazardous. Some are poisonous, others are flammable. Always follow the instructions on the particular container. Always open your vehicle's doors or windows when cleaning the inside.

Never use fluids or solvents that are not designed for cleaning your vehicle.

While in operation, even while parked, your vehicle is subjected to varying external influences which, if gone unchecked, can attack the paintwork as well as the underbody and cause lasting damage.

Such damage is caused not only by extreme and varying climatic conditions, but also by:

- Air pollution
- Road salt
- Tar
- Gravel and stone chipping

To avoid paint damage, you should immediately remove:

- Grease and oil
- Fuel
- Coolant
- Brake fluid
- Bird droppings
- Insects
- Tree resins, etc.

Frequent washing reduces and/or eliminates the aggressiveness and potency of the above adverse influences.

More frequent washings are necessary to deal with unfavorable conditions:

- near the ocean
- in industrial areas (smoke, exhaust emissions)
- during winter operation

You should check your vehicle from time to time for stone chipping or other damage. Any damage should be repaired as soon as possible to prevent corrosion.

In doing so, do not neglect the underbody of the vehicle. A prerequisite for a thorough check is a washing of the underbody followed by a thorough inspection. Damaged areas need to be re-undercoated.

Your vehicle has been treated at the factory with a wax-base rustproofing in the body cavities which will last for the lifetime of the vehicle. Post-production treatment is neither necessary nor recommended by Mercedes-Benz because of the possibility of incompatibility between materials used in the production process and others applied later.

Operation

Vehicle care

We have selected car-care products and compiled recommendations which are specially matched to our vehicles and which always reflect the latest technology. You can obtain Mercedes-Benz approved car-care products at your authorized Mercedes-Benz Center.

Scratches, corrosive deposits, corrosion or damage due to negligent or incorrect care cannot always be removed or repaired with the car-care products recommended here. In such cases it is best to seek aid at your authorized Mercedes-Benz Center.

The following topics deal with the cleaning and care of your vehicle and give important “how-to” information as well as references to Mercedes-Benz approved car-care products.

Additional information can be found in the booklet “Vehicle Care Guide”.

Power washer

When using a power washer for cleaning the vehicle, always observe the manufacturer’s operating instructions.



Never use a round nozzle to power-wash tires. The intense jet of water can result in damage to the tire.

Always replace a damaged tire.

Always keep the jet of water moving across the surface. Do not aim directly at electrical parts, electrical connectors, seals, or other rubber parts.

Tar stains

Quickly remove tar stains before they dry and become more difficult to remove. A tar remover is recommended.

Paintwork, painted body components

Mercedes-Benz approved Paint Care should be applied when water drops on the paint surface do not “bead up”, normally every three to five months, depending on climate and washing detergent used.

Mercedes-Benz approved Paint Cleaner should be applied if the paint surface shows signs of embedded dirt (i.e. loss of gloss).

Do not apply any of these products or wax if your vehicle is parked in the sun or if the hood is still hot.

Use the appropriate MB-Touch-Up Stick for quick and provisional repairs of minor paint damage (i.e. chips from stones, vehicle doors, etc.).

Engine cleaning

Prior to cleaning the engine compartment, make sure to protect electrical components and connectors from the intrusion of water and cleaning agents.

Corrosion protection, such as MB Anticorrosion Wax, should be applied to the engine compartment after every engine cleaning. Before applying, all control linkage bushings and joints should be lubricated. The poly-V-belt and all pulleys should be protected from any wax.

Vehicle washing

Do not use hot water or wash your vehicle in direct sunlight. Only use a mild car wash detergent, such as Mercedes-Benz approved Car Shampoo.

Thoroughly spray the vehicle with a diffused jet of water. Direct only a very weak spray towards the ventilation intake. Use plenty of water and rinse the sponge and chamois frequently.

Rinse with clear water and thoroughly dry with a chamois. Do not allow cleaning agents to dry on the finish.

Due to the width of the vehicle, fold in outside mirrors prior to running the vehicle through an automatic car wash to prevent damage to the mirrors.

In the winter, thoroughly remove all traces of road salt as soon as possible.

When washing the underbody, do not forget to clean the inner sides of the wheels.

Ornamental moldings

For regular cleaning and care of very dirty chrome-plated parts, use a chrome cleaner.

Headlamps, tail lamps, side markers, turn signal lenses

Use a mild car wash detergent, such as Mercedes-Benz approved Car Shampoo, with plenty of water.

To prevent scratches, never apply strong force and only use a soft, non-scratchy cloth when cleaning the lenses. Do not attempt to wipe dirty lenses with a dry cloth or sponge.

Operation

Vehicle care

Wiper blades

- ▶ Fold wiper arms forward.

Warning!



For safety reasons, switch off wipers and remove SmartKey from starter switch before cleaning the wiper blades, otherwise the wiper motor might suddenly turn on and cause injury.

- ▶ Clean the wiper blade inserts with a clean cloth and detergent solution.



Fold the windshield wiper arms back onto the windshield before turning the SmartKey in the starter switch.

Hold on to the wiper when folding the wiper arm back. If released, the force of the impact from the tensioning spring could crack the windshield.

Window cleaning

- ▶ Fold wiper arms forward.

Warning!



For safety reasons, switch off wipers and remove SmartKey from starter switch before cleaning the windshield, otherwise the wiper motor might suddenly turn on and cause injury.

- ▶ Use a window cleaning solution on all glass surfaces.

An automotive glass cleaner is recommended.



Fold the windshield wiper arms back onto the windshield before turning the SmartKey in the starter switch.

Hold on to the wiper when folding the wiper arm back. If released, the force of the impact from the tensioning spring could crack the windshield.

Light alloy wheels

Mercedes-Benz approved Wheel Care should be used for regular cleaning of the light alloy wheels.

If possible, clean wheels once a week with Mercedes-Benz approved Wheel Care, using a soft bristle brush and a strong spray of water.

Follow the instructions on container.



Only use acid-free cleaning materials. Acid may cause corrosion or damage the clear coat.

Instrument cluster

Use a gentle dishwashing detergent or mild detergent for delicate fabrics as a washing solution. Wipe with a cloth moistened in lukewarm solution. Do not use scouring agents.

Steering wheel and gear selector lever

Wipe with a damp cloth and dry thoroughly or clean with Mercedes-Benz approved Leather Care.

Cup holder

Use a gentle dishwashing detergent or mild detergent for delicate fabrics as a washing solution. Wipe with a cloth moistened in lukewarm solution. Do not use scouring agents.

Hard plastic trim items

Pour Mercedes-Benz approved Interior Care onto soft lint-free cloth and apply with light pressure.

Headliner and rear window shelf

Clean with soft bristle brush, or use a dry-shampoo cleaner in case of excessive dirt.

Seat belts

The webbing must not be treated with chemical cleaning agents. Only use clear, lukewarm water and soap. Do not dry the webbing at temperatures above 176°F (80°C) or in direct sunlight.

Warning!

Do not bleach or dye seat belts as this may severely weaken them. In a crash they may not be able to provide adequate protection.

Upholstery

Using aftermarket seat covers or wearing clothing that have the tendency to give off coloring (e.g. when wet, etc.) may cause the upholstery to become permanently discolored. By lining the seats with a proper intermediate cover, contact-discoloration will be prevented.

Leather upholstery

Wipe leather upholstery with a damp cloth and dry thoroughly or clean with Mercedes-Benz approved Leather Care. Exercise particular care when cleaning perforated leather as its underside should not become wet.

Operation

Vehicle care

Cloth upholstery

Clean with soft bristle brush, or use a dry-shampoo cleaner in case of excessive dirt.

MB Tex upholstery

Pour Mercedes-Benz approved Interior Care onto soft lint-free cloth and apply with light pressure.

Plastic and rubber parts

Do not use oil or wax on these parts.

Wood trims

Dampen cloth using water and use damp cloth to clean wood trims in your vehicle. Do not use solvents like tar remover or wheel cleaner nor polishes or waxes as these may be abrasive.

A close-up, artistic photograph of a Mercedes-Benz wheel. The central three-pointed star logo is the focal point, surrounded by the spokes and the rim of the wheel. The lighting is soft and blue-toned, creating a sense of depth and texture. The background is blurred, showing more of the wheel's structure.

Practical hints

What to do if ...

Where will I find ...?

Unlocking/locking in an emergency

Opening/closing in an emergency

Replacing bulbs

Replacing wiper blades

Flat tire

Battery

Jump starting

Towing the vehicle

Fuses

Practical hints

What to do if ...

▼ What to do if ...

Lamps in instrument cluster

General information:



If a bulb in the instrument cluster fails to come on during the bulb self-check when

turning the SmartKey in the starter switch to position **2**, have it checked and replaced if necessary.

Problem	Possible cause	Suggested solution
 The yellow ABS malfunction indicator lamp comes on while driving.	<p>The ABS has detected a malfunction and has switched off. The BAS and the ESP are also switched off (see messages in display).</p> <p>The brake system is still functioning normally but without the ABS available.</p>	<ul style="list-style-type: none"> ▶ Continue driving with added caution. Wheels may lock during hard braking, reducing steering capability. ▶ Have the system checked at an authorized Mercedes-Benz Center as soon as possible. <p>Failure to follow these instructions increases the risk of an accident.</p> <ul style="list-style-type: none"> ▶ Read and observe messages in the display (▷ page 280).
	<p>The charging voltage has fallen below ten volts. The ABS has switched off.</p>	<ul style="list-style-type: none"> ▶ When the voltage is above this value again, the ABS is operational again. ▶ If necessary, have the generator (alternator) and battery checked.

Practical hints

What to do if ...

Problem		Possible cause	Suggested solution
 (Canada only)	The red brake warning lamp comes on while driving and you hear a warning sound.	You are driving with the parking brake set.	▶ Release the parking brake (▷ page 45).
 (USA only)	The red brake warning lamp comes on while driving.	There is insufficient brake fluid in the reservoir.	▶ Risk of accident! Carefully stop the vehicle and notify an authorized Mercedes-Benz Center. Do not add brake fluid! This will not solve the problem.

Warning!



Driving with the brake warning lamp illuminated can result in an accident. Have your brake system checked immediately if the brake warning lamp stays on. Don't add brake fluid before checking the brake system. Overfilling the brake fluid reservoir can result in spilling brake fluid on hot engine parts and the brake fluid catching fire. You can be seriously burned.



If you find that the brake fluid in the brake fluid reservoir has fallen to the minimum mark or below, have the brake system checked for brake pad thickness and leaks.

Practical hints

What to do if ...

Problem	Possible cause	Suggested solution
CHECK ENGINE The yellow "CHECK ENGINE" malfunction indicator lamp comes on while driving.	There is a malfunction in: <ul style="list-style-type: none"> • The fuel management system • The ignition system • The emission control system • Systems which affect emissions Such malfunctions may result in excessive emissions values and may switch the engine to its limp-home (emergency operation) mode.	► Have the vehicle checked as soon as possible by an authorized Mercedes-Benz Center. An on-board diagnostic connector is used by the service station to link the vehicle to the shop diagnostics system. It allows the accurate identification of system malfunctions through the readout of diagnostic trouble codes. It is located in the front left area of the footwell next to the parking brake pedal.
	The fuel cap is not closed tight.	► Check the fuel cap.
	Your gas tank is empty.	► After refuelling start the engine three or four times in succession. The limp-home mode is canceled. You do not need to have your vehicle checked.

Practical hints

What to do if ...

Problem	Possible cause	Suggested solution
 The yellow ESP warning lamp comes on while driving.	The ESP is deactivated. Risk of accident! Adapt your speed and driving to the prevailing road, weather and traffic conditions.	▶ Switch the ESP back on (▷ page 74). If the ESP cannot be switched back on, have the system checked at an authorized Mercedes-Benz Center as soon as possible.
The yellow ESP warning lamp flashes while driving.	The ESP or traction control has come into operation because of detected traction loss in at least one tire.	▶ When driving off, apply as little throttle as possible. ▶ While driving, ease up on the accelerator. ▶ Adapt your speed and driving to the prevailing road and weather conditions. ▶ Do not deactivate the ESP. Exceptions: (▷ page 74). Failure to follow these instructions increases the risk of an accident.

Practical hints

What to do if ...

Problem	Possible cause	Suggested solution
The yellow fuel tank reserve warning lamp comes on while driving.	The fuel level has gone below the reserve mark.	▶ Refuel at the next gas station (▷ page 249).
 The red seat belt non-usage warning lamp illuminates for a brief period after starting the engine.	The warning lamp reminds you to fasten seat belts.	▶ Fasten your seat belt.
SRS The red SRS indicator lamp comes on while driving.	There is a malfunction in the restraint systems. The airbags or emergency tensioning device (ETDs) could deploy unexpectedly or fail to activate in an accident.	▶ Drive with added caution to the nearest authorized Mercedes-Benz Center.

Warning!



In the event a malfunction of the SRS is indicated as outlined above, the SRS may not be operational. For your safety, we strongly recommend that you visit an authorized Mercedes-Benz Center immediately to have the system checked; otherwise the SRS may not be activated when needed in an accident, which could result in serious or fatal injury, or it might deploy unexpectedly and unnecessarily which could result in an accident and/or injury to you or to others.

Lamp in center console

Problem	Possible cause	Suggested solution
<p>PASS. AIRBAG OFF The indicator lamp comes on.</p>	<p>A BabySmart^{TM1} child seat is installed on the front passenger seat. Therefore the passenger front airbag is switched off.</p>	
<p>The indicator lamp does not come on with a BabySmartTM child seat properly installed on the front passenger seat.</p>	<p>The system is malfunctioning when there is no BabySmartTM child seat installed on the front passenger seat.</p> <p>The system is malfunctioning.</p>	<ul style="list-style-type: none"> ▶ Have the system checked as soon as possible by an authorized Mercedes-Benz Center. ▶ Make sure there is nothing between seat cushion and child seat and check installation of the child seat. ▶ If the lamp remains out, have the system checked as soon as possible by an authorized Mercedes-Benz Center. <p>Do not use the BabySmartTM restraint to transport children on the front passenger seat until the system has been repaired.</p>

¹ BabySmartTM is a trademark of Siemens Automotive Corp.

Practical hints

What to do if ...

Messages in the display

The control system shows warning and malfunction messages in the multifunction display.

Certain warning and malfunction messages are accompanied by an audible signal.

Address these messages accordingly and follow the additional instructions given in this Operator's Manual.

Selecting the malfunction memory menu in the control system (▷ page 122) displays both cleared and uncleared messages.

High-priority messages appear in the multifunction display in red color.

Certain messages of high priority cannot be cleared from the multifunction display using the reset button.

Other messages of high priority and messages of less immediate priority can be cleared from the multifunction display using the reset button (▷ page 22) and are then stored in the malfunction message memory (▷ page 122).

Warning!



All categories of messages contain important information which should be taken note of and, where a malfunction is indicated, addressed as soon as possible at an authorized Mercedes-Benz Center.

Failure to repair condition noted may cause damage not covered by the Mercedes-Benz Limited Warranty, or result in property damage or personal injury.

Warning!



No messages will be displayed if either the instrument cluster or the multifunction display is inoperative.

Contact your nearest authorized Mercedes-Benz Center.



Turning the SmartKey in starter switch to position **2**, causes all lamps as well as the multifunction display to come on. Ensure that they are all in working order before starting your journey.

On the pages that follow, you will find a compilation of the most important warning and malfunction messages that may appear in the display. High priority messages appear on a red background.

Text messages

Display message		Possible cause	Possible solution
BAS	BRAKE ASSIST NOT AVAILABLE!	The charging voltage has fallen below ten volts. The BAS has switched off.	<ul style="list-style-type: none"> ▶ When the voltage is above this value again, the BAS is operational again. ▶ If necessary, have the generator and battery checked.
	BRAKE ASSIST VISIT WORKSHOP!	The BAS has detected a malfunction and switched off. The brake system is still functioning normally but without the BAS available.	<ul style="list-style-type: none"> ▶ Continue driving with added caution. ▶ Have the system checked at an authorized Mercedes-Benz Center as soon as possible. <p>Failure to follow these instructions increases the risk of an accident.</p>
	DISPLAY MALFUNCTION VISIT WORKSHOP!	The BAS or the BAS display is malfunctioning.	<ul style="list-style-type: none"> ▶ Continue driving with added caution. ▶ Have the system checked at an authorized Mercedes-Benz Center as soon as possible. <p>Failure to follow these instructions increases the risk of an accident.</p>

Practical hints

What to do if ...

Display message	Possible cause	Possible solution
ESP ESP NOT AVAILABLE!	The ESP was deactivated because of a malfunction or interrupted power supply. The ABS might not be operational.	<ul style="list-style-type: none">▶ Synchronize the ESP. With vehicle stationary and the engine running, turn the steering wheel completely to the left and then to the right to synchronize the ESP. <p>If the ESP message does not go out:</p> <ul style="list-style-type: none">▶ Continue driving with added caution.▶ Visit an authorized Mercedes-Benz Center as soon as possible. <p>Failure to follow these instructions increases the risk of an accident.</p>
	The self-diagnosis has not been completed.	The display will clear after driving a short distance at more than 12 mph (20 km/h).



When synchronizing the ESP, make sure you can turn the steering wheel in both directions as far as it will go without the wheels hitting any objects, e.g. a road curb.

Practical hints

What to do if ...

Display message	Possible cause	Possible solution
ESP ESP NOT AVAILABLE!	The charging voltage has fallen below ten volts. The ESP has switched off.	<ul style="list-style-type: none">▶ When the voltage is above this value again, the ESP is operational again.▶ If necessary, have the generator and battery checked.
ESP VISIT WORKSHOP!	The ESP is deactivated because of a malfunction.	<ul style="list-style-type: none">▶ Continue driving with added caution.▶ Visit an authorized Mercedes-Benz Center as soon as possible. <p>Failure to follow these instructions increases the risk of an accident.</p>
DISPLAY MALFUNCTION VISIT WORKSHOP!	The ESP or the ESP display is malfunctioning.	<ul style="list-style-type: none">▶ Continue driving with added caution.▶ Visit an authorized Mercedes-Benz Center as soon as possible. <p>Failure to follow these instructions increases the risk of an accident.</p>

Practical hints

What to do if ...

Symbol messages

Display symbol	Display message	Possible cause	Possible solution
	ABS SYSTEM VISIT WORKSHOP!	<p>The ABS has detected a malfunction and has switched off. The ESP and the BAS are also deactivated.</p> <p>The brake system is still functioning normally but without the ABS available.</p>	<ul style="list-style-type: none">▶ Continue driving with added caution. Wheels may lock during hard braking, reducing steering capability.▶ Have the system checked at an authorized Mercedes-Benz Center as soon as possible. <p>Failure to follow these instructions increases the risk of an accident.</p>
	DISPLAY MALFUNCTION VISIT WORKSHOP!	The ABS or the ABS display is malfunctioning.	<ul style="list-style-type: none">▶ Continue driving with added caution. Wheels may lock during hard braking, reducing steering capability.▶ Have the system checked at an authorized Mercedes-Benz Center as soon as possible. <p>Failure to follow these instructions increases the risk of an accident.</p>





Practical hints

What to do if ...

Display symbol	Display message	Possible cause	Possible solution
	BATTERY/ALTERNATOR VISIT WORKSHOP!	The battery was charged with a battery charger or jump started.	► Have the battery checked at a service station.
		The battery is no longer charging. Possible causes: <ul style="list-style-type: none"> • alternator malfunctioning • broken poly-V-belt 	► Stop immediately and check the poly-V-belt. If it is broken: <ul style="list-style-type: none"> ► Do not continue to drive. Otherwise the engine will overheat due to an inoperative water pump which may result in damage to the engine. Notify an authorized Mercedes-Benz Center. If it is intact: <ul style="list-style-type: none"> ► Drive immediately to the nearest authorized Mercedes-Benz Center.
	UNDERVOLTAGE ENGINE ON!	The battery has insufficient voltage and can no longer supply the convenience functions such as seat heater*.	► Start the engine (▷ page 43).
	UNDERVOLTAGE SWITCH CONSUMERS OFF!	The battery is malfunctioning.	► Have the battery checked at a service station.

Practical hints

What to do if ...

Display symbol	Display message	Possible cause	Possible solution
 (Canada only)  (USA only)	PARK. BRAKE RELEASE BRAKE!	You are driving with the parking brake set.	► Release the parking brake (▷ page 45).
	BRAKE WEAR VISIT WORKSHOP!	The brake pads have reached their wear limit.	► Have the brake pads replaced as soon as possible.
	BRAKE FLUID VISIT WORKSHOP!	There is insufficient brake fluid in the reservoir.	► Risk of accident! Stop the vehicle and notify an authorized Mercedes-Benz Center. Do not add brake fluid! This will not solve the problem.

Warning!



Driving with this message displayed can result in an accident. Have your brake system checked immediately. Do not add brake fluid before checking the brake system. Overfilling the brake fluid reservoir can result in spilling brake fluid on hot engine parts and the brake fluid catching fire. You can be seriously burned.



If you find that the brake fluid in the brake fluid reservoir has fallen to the minimum mark or below, have the brake system checked for brake pad thickness and leaks.



Brake pad thickness must be visually checked by a qualified technician at the intervals specified in the Service booklet.

Practical hints

What to do if ...

Display symbol	Display message	Possible cause	Possible solution
	COOLANT CHECK LEVEL!	The coolant level is too low.	<ul style="list-style-type: none">▶ Add coolant (▷ page 257).▶ If you have to add coolant frequently, have the cooling system checked by an authorized Mercedes-Benz Center.

Warning!



Do not spill antifreeze on hot engine parts. Antifreeze contains ethylene glycol which may burn if it comes into contact with hot engine parts. You can be seriously burned.



Do not ignore the low engine coolant level warning. Extended driving with the message and symbol displayed may cause serious engine damage not covered by the Mercedes-Benz Limited Warranty.

Do not drive without sufficient amount of coolant in the cooling system. The engine will overheat causing major engine damage.

Practical hints

What to do if ...

Display symbol	Display message	Possible cause	Possible solution
	COOLANT STOP, ENGINE OFF!	The coolant is too hot.	<ul style="list-style-type: none">▶ Stop the vehicle and turn off the engine.▶ Only start the engine again after the message disappears. You could otherwise damage the engine.

Warning!



Driving when your engine is badly overheated can cause some fluids which may have leaked into the engine compartment to catch fire. You could be seriously burned.

Steam from an overheated engine can cause serious burns and can occur just by opening the hood. Stay away from the engine if you see or hear steam coming from it.

Turn off the engine, get out of the vehicle and do not stand near the vehicle until the engine has cooled down.

During severe operating conditions and stop-and-go city traffic, the coolant temperature may rise close to 248°F (120°C).



The engine should not be operated with the coolant temperature above 248°F (120°C). Doing so may cause serious engine damage which is not covered by the Mercedes-Benz Limited Warranty.





Practical hints

What to do if ...

Display symbol	Display message	Possible cause	Possible solution
	COOLANT STOP, ENGINE OFF!	The poly-V-belt could be broken.	<ul style="list-style-type: none">▶ Stop immediately and check the poly-V-belt. If it is broken: <ul style="list-style-type: none">▶ Do not continue to drive. Otherwise the engine will overheat due to an inoperative water pump which may result in damage to the engine. Notify an authorized Mercedes-Benz Center. If it is intact: <ul style="list-style-type: none">▶ Do not continue to drive the vehicle with this message displayed. Doing so could result in serious engine damage that is not covered by the Mercedes-Benz Limited Warranty.
	COOLANT VISIT WORKSHOP!	The cooling fan for the coolant is malfunctioning.	<ul style="list-style-type: none">▶ Observe the coolant temperature display.▶ Have the fan replaced as soon as possible.

Practical hints

What to do if ...

Display symbol	Display message	Possible cause	Possible solution
	CRUISE CONTROL DRIVE TO WORKSHOP!	Cruise control is malfunctioning.	▶ Visit an authorized Mercedes-Benz Center.
	VISIT WORKSHOP! DISPLAY MALFUNCTION	The instrument cluster display is malfunctioning.	▶ Continue driving with added caution. ▶ Visit an authorized Mercedes-Benz Center as soon as possible.
		The displays for several systems have malfunctioned. Some systems themselves may also have malfunctioned.	▶ Have the electronic systems checked by an authorized Mercedes-Benz Center.
	VISIT WORKSHOP! DISPLAY MALFUNCTION	Certain electronic systems are unable to relay information to the control system. The following systems may have failed: <ul style="list-style-type: none"> • Coolant temperature display • Tachometer • Cruise control display 	▶ Have the electronic systems checked by an authorized Mercedes-Benz Center (▷ page 276).
	DOOR OPEN!	You are attempting to drive with one or more doors open.	▶ Close the doors.

Practical hints

What to do if ...

Display symbol	Display messages	Possible cause	Suggested solution
	USA only: ADD 1.0 Qt. ENGINE OIL WHEN NEXT REFUELING! Canada only: ADD 1.0 LITER ENG. OIL WHEN NEXT REFUELING!	The engine oil level is too low.	▶ Add engine oil (▷ page 255) and check the engine oil level (▷ page 254).
	ENGINE OIL LEVEL STOP, ENGINE OFF!	There is no oil in the engine. There is a danger of engine damage.	▶ Carefully bring the vehicle to a halt as soon as possible. ▶ Turn off the engine. ▶ Add engine oil (▷ page 255) and check the engine oil level (▷ page 254).
	ENGINE OIL LEVEL REDUCE OIL LEVEL	You have added too much engine oil. There is a risk of damaging the engine or the catalytic converter.	▶ Have oil siphoned or drained off. Observe all legal requirements with respect to its disposal.
	ENGINE OIL VISIT WORKSHOP!	It may be that there is water in the engine oil.	▶ Have the engine oil checked.

Practical hints

What to do if ...

Display symbol	Display messages	Possible cause	Suggested solution
	ENGINE OIL LEVEL VISIT WORKSHOP!	The engine oil has dropped to a critical level.	<ul style="list-style-type: none"> ▶ Check the engine oil level (▷ page 254) and add oil as required (▷ page 255). ▶ If you must add engine oil frequently, have the engine checked for possible leaks.
	ENGINE OIL SENSOR VISIT WORKSHOP!	The measuring system is malfunctioning.	▶ Have the measuring system checked by an authorized Mercedes-Benz Center.

When the message ADD 1.0 Qt. ENGINE OIL WHEN NEXT REFUELING! (Canada: 1.0 LITER) appears while the engine is running and at operating temperature, the engine oil level has dropped to approximately the minimum level.

When this occurs, the warning will first come on intermittently and then stay on if the oil level drops further.





Visually check for oil leaks. If no obvious oil leaks are noted, drive to the nearest service station where the engine oil should be topped to the required level with an approved oil.



The engine oil level warnings should not be ignored. Extended driving with the symbol displayed could result in serious engine damage that is not covered by the Mercedes-Benz Limited Warranty.

Practical hints

What to do if ...

Display symbol	Display message	Possible cause	Possible solution
	RESERVE FUEL GO TO GAS STATION!	The fuel level has dropped below the reserve mark.	▶ Refuel at the next gas station (▷ page 249).
	CHECK GAS CAP! SEE OPERATOR'S MANUAL	The fuel cap is not closed tightly.	▶ Check the fuel cap (▷ page 249).
	HOOD OPEN!	You are driving with the hood open.	▶ Close the hood (▷ page 252).
	REMOVE KEY!	You have forgotten to remove the SmartKey.	▶ Remove the SmartKey from the starter switch.
	REPLACE KEY! DRIVE TO WORKSHOP!	No additional code available for SmartKey.	▶ Change the SmartKey.
	3RD BRAKE LIGHT CHECK LIGHT!	The high mounted brake lamp is malfunctioning.	▶ Visit an authorized Mercedes-Benz Center as soon as possible.
	AUTOM. LIGHT ON REMOVE KEY!	SmartKey in starter switch position 1 or 2 .	▶ Remove SmartKey from the starter switch.
	BRAKE LIGHT DRIVE TO WORKSHOP!	Brake lamp illumination is delayed or lamp is permanently on.	▶ Visit an authorized Mercedes-Benz Center as soon as possible.
	BRAKE LIGHT, L CHECK LIGHT!	The left brake lamp is malfunctioning.	▶ Visit an authorized Mercedes-Benz Center as soon as possible.
	BRAKE LIGHT, R CHECK LIGHT!	The right brake lamp is malfunctioning.	▶ Visit an authorized Mercedes-Benz Center as soon as possible.
	DISPLAY MALFUNCTION VISIT WORKSHOP!	The display for the lamps or the system is malfunctioning.	▶ Visit an authorized Mercedes-Benz Center as soon as possible.

Practical hints

What to do if ...

Display symbol	Display message	Possible cause	Possible solution
	FRONT FOGLIGHT, L CHECK LIGHT!	The left front fog lamp is malfunctioning.	▶ Replace the bulb as soon as possible.
	FRONT FOGLIGHT, R CHECK LIGHT!	The right front fog lamp is malfunctioning.	▶ Replace the bulb as soon as possible.
	REAR FOGLIGHT CHECK LIGHT!	The rear fog lamp is malfunctioning.	▶ Replace the bulb as soon as possible.
	HIGH BEAM, L CHECK LIGHT!	The left high beam lamp is malfunctioning.	▶ Replace the bulb as soon as possible.
	HIGH BEAM, R CHECK LIGHT!	The right high beam lamp is malfunctioning.	▶ Replace the bulb as soon as possible.
	LIGHT SENSOR VISIT WORKSHOP!	The lamp sensor is malfunctioning. The headlamps switch on automatically.	<ul style="list-style-type: none"> ▶ In the control system, set lamp operation to manual (▷ page 123). ▶ Switch on headlamps using the exterior lamp switch. ▶ Visit an authorized Mercedes-Benz Center as soon as possible.
	LICENSE PLATE LIGHT, L CHECK LIGHT!	The left license plate lamp is malfunctioning.	▶ Replace the bulb as soon as possible.
	LICENSE PLATE LIGHT, R CHECK LIGHT!	The right license plate lamp is malfunctioning.	▶ Replace the bulb as soon as possible.

Practical hints

What to do if ...

Display symbol	Display message	Possible cause	Possible solution
	LIGHTS TURN OFF LIGHTS!	This display appears if the driver's door is opened and no SmartKey in the starter switch.	<ul style="list-style-type: none"> ▶ Insert SmartKey in the starter switch. ▶ Switch off the headlights.
	LOW BEAM, L CHECK LIGHT!	The left low beam lamp is malfunctioning.	▶ Visit an authorized Mercedes-Benz Center as soon as possible.
	LOW BEAM, R CHECK LIGHT!	The right low beam lamp is malfunctioning.	▶ Visit an authorized Mercedes-Benz Center as soon as possible.
	REVERSE LIGHT, L CHECK LIGHT!	The left backup lamp is malfunctioning.	▶ Replace the bulb as soon as possible.
	REVERSE LIGHT, R CHECK LIGHT!	The right backup lamp is malfunctioning.	▶ Replace the bulb as soon as possible.
	MARKER LIGHT, FL CHECK LIGHTS! BACK-UP LIGHT ON!	The left parking lamps are malfunctioning. A backup bulb is being used.	▶ Visit an authorized Mercedes-Benz Center as soon as possible.
	MARKER LIGHT, FR CHECK LIGHTS! BACK-UP LIGHT ON!	The right parking lamps are malfunctioning. A backup bulb is being used.	▶ Visit an authorized Mercedes-Benz Center as soon as possible.
	TAIL LIGHT, L CHECK LIGHTS! BACK-UP LIGHT ON!	The left tail lamp is malfunctioning. A backup bulb is being used.	▶ Visit an authorized Mercedes-Benz Center as soon as possible.

Practical hints

What to do if ...

Display symbol	Display message	Possible cause	Possible solution
	TAIL LIGHT, R CHECK LIGHTS! BACK-UP LIGHT ON!	The right tail lamp is malfunctioning. A backup bulb is being used.	▶ Visit an authorized Mercedes-Benz Center as soon as possible.
	TURN SIG., LF CHECK LIGHT!	The left front turn signal lamp is malfunctioning.	▶ Replace the bulb as soon as possible.
	TURN SIG., RF CHECK LIGHT!	The right front turn signal lamp is malfunctioning.	▶ Replace the bulb as soon as possible.
	TURN SIG., LR CHECK LIGHT!	The left rear turn signal lamp is malfunctioning.	▶ Replace the bulb as soon as possible.
	TURN SIG., RR CHECK LIGHT!	The right rear turn signal lamp is malfunctioning.	▶ Replace the bulb as soon as possible.
	TURN SIG. MIRROR, L CHECK LIGHT!	The left turn signal in the side mirror is malfunctioning. This message will only appear if all light emitting diodes have stopped working.	▶ Have the LEDs replaced as soon as possible.
	TURN SIG. MIRROR, R CHECK LIGHT!	The right turn signal in the side mirror is malfunctioning. This message will only appear if all light emitting diodes have stopped working.	▶ Have the LEDs replaced as soon as possible.

Practical hints

What to do if ...

Display symbol	Display message	Possible cause	Possible solution
	DRIVER'S SEAT BELT FASTEN SEAT BELT!	The display reminds you and your passengers to fasten seat belts.	► Fasten the seat belts.
	FR. PASS. SEAT BELT FASTEN SEAT BELT!	The display reminds you and your passengers to fasten seat belts.	► Fasten the seat belts.
	SEAT BELT SYSTEM DRIVE TO WORKSHOP!	The seat belt system is malfunctioning.	► Visit an authorized Mercedes-Benz Center as soon as possible.
SRS	RESTRAINT SYSTEM DRIVE TO WORKSHOP!	The system is malfunctioning.	► Drive with added caution to the nearest authorized Mercedes-Benz Center.

Warning!



In the event a malfunction of the SRS is indicated as outlined above, the SRS may not be operational. For your safety, we strongly recommend that you visit an authorized Mercedes-Benz Center immediately to have the system checked; otherwise the SRS may

not be activated when needed in an accident, which could result in serious or fatal injury, or it might deploy unexpectedly and unnecessarily which could also result in injury.

Practical hints

What to do if ...

Display symbol	Display message	Possible cause	Possible solution
	STEERING WHEEL ADJ. LOCK!	The steering column is not properly locked.	▶ Lock steering column (▷ page 37).
	STEERING OIL VISIT WORKSHOP!	The steering gear oil level is too low. There is a danger of steering gear damage.	▶ Have the system checked by an authorized Mercedes-Benz Center.

Warning!











If the level of steering gear oil in reservoir is too low, the steering power assistance could fail. Much greater effort will then be needed to turn the steering wheel.

Do not add steering oil without checking the steering system.

Do not drive the vehicle. Have the system checked at your authorized Mercedes-Benz Center as soon as possible.

Practical hints

What to do if ...

Display symbol	Display message	Possible cause	Possible solution
	CLOSE SUNROOF!	You have opened the driver's door with the SmartKey removed from the starter switch and the sliding/pop-up roof open.	▶ Close the sliding/pop-up roof (▷ page 203).
	CLOSE SUNROOF!	You have opened the driver's door with the SmartKey removed from the starter switch and the sliding/pop-up roof open.	▶ Close the sliding/pop-up roof (▷ page 203).
	TELE AID DRIVE TO WORKSHOP!	One or more main functions of the Tele Aid system* are malfunctioning.	▶ Have the Tele Aid system* checked by an authorized Mercedes-Benz Center.
	FUNCTION NOT AVAILABLE!	This display appears if button  or  on the multifunction steering wheel is pressed and the vehicle is not equipped with a telephone*.	
	TRUNK OPEN!	This message will appear whenever the trunk lid is open.	▶ Close the trunk lid.
	WASHER FLUID CHECK LEVEL!	The fluid level has dropped to about $\frac{1}{3}$ of total reservoir capacity.	▶ Add washer fluid (▷ page 259).

Practical hints

Where will I find ...?

▼ Where will I find ...?

First aid kit

The first aid kit is located in the trunk on the left side secured by a velcro strap.



- ▶ Unfasten velcro strap.
- ▶ Remove first aid kit.



Check expiration dates and contents for completeness at least once a year and replace missing/expired items.

Vehicle tool kit

The vehicle tool kit is located in the storage compartment underneath the trunk floor.

The following is included:

- Towing eye bolt
- Wheel wrench
- Alignment bolt
- Vehicle jack
- Wheel bolts
- Special fuse extractor
- Spare fuses

Removing the vehicle tool kit

- ▶ Lift up trunk floor cover and engage trunk floor handle in upper edge of trunk.



- ① Retaining screw
- ② Storage well casing

- ▶ Loosen retaining screw ① in the middle of storage well casing ②.
- ▶ Remove storage well casing ②.

Practical hints

Where will I find ...?

- ▶ Remove vehicle tool kit ⑥.

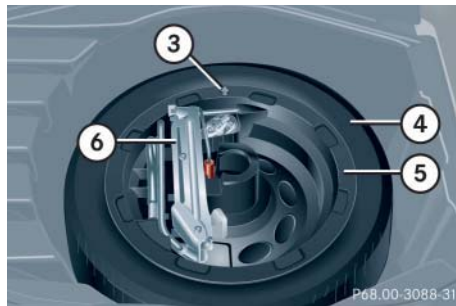

- ③ Arrow
- ④ Minispare wheel
- ⑤ Vehicle tool kit storage well casing
- ⑥ Vehicle tool kit
- Wheel wrench
- Vehicle jack

Storing the vehicle tool kit

- ▶ Place vehicle tool kit ⑥ in vehicle tool kit storage well casing ⑤.
- ▶ Place storage well casing ② over the vehicle tool kit storage well casing ⑤ and turn retaining screw ① clockwise as far it will go to secure the Minispare wheel.



Arrow ③ on vehicle tool kit storage well casing ⑤ must point in the direction of travel. Otherwise you cannot place the storage well casing ② on top and secure the Minispare wheel with retaining screw ①.



To prevent damage, always disengage trunk floor handle from upper edge of trunk and lower trunk floor before closing the trunk lid.

Vehicle jack

Warning!



The jack is designed exclusively for jacking up the vehicle at the jack take-up brackets built into both sides of the vehicle. To help avoid personal injury, use the jack only to lift the vehicle during a wheel change. Never get beneath the vehicle while it is supported by the jack. Keep hands and feet away from the area under the lifted vehicle. Always firmly set parking brake and block wheels before raising vehicle with jack.

Do not disengage parking brake while the vehicle is raised. Be certain that the jack is always vertical (plumb line) when in use, especially on hills. Always try to use the jack on level surface. Make sure the jack arm is fully seated in the jack take-up bracket. Always lower the vehicle onto sufficient capacity jackstands before working under the vehicle.

Practical hints

Where will I find ...?

The vehicle jack is located in the storage compartment underneath the trunk floor together with the vehicle tool kit in the vehicle tool kit storage well casing.

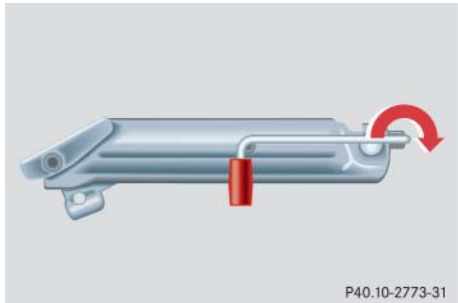

Storage position

- ▶ Remove vehicle jack from its compartment.
- ▶ Push crank handle up.

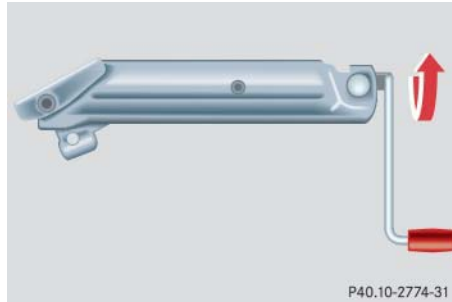

Operational position

- ▶ Turn crank handle clockwise until it engages (operational position).

Before storing the vehicle jack in its compartment:

- It should be fully collapsed.
- The handle must be folded in (storage position).

Minispare wheel

The Minispare wheel is located in the storage compartment underneath the trunk floor.

Removing the Minispare wheel

- ▶ Lift up trunk floor cover and engage trunk floor handle in upper edge of trunk.
- ▶ Loosen the retaining screw (▷ page 300) in the middle of storage well casing.
- ▶ Remove the storage well casing (▷ page 300).

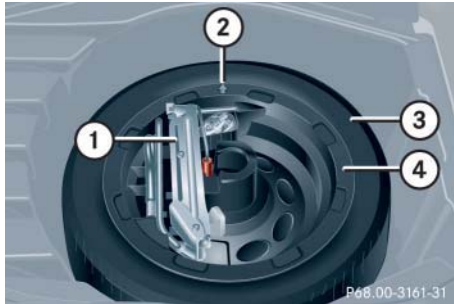

- ① Vehicle tool kit
Wheel wrench
Vehicle jack
- ② Arrow
- ③ Minispare wheel
- ④ Vehicle tool kit storage well casing

- ▶ Remove vehicle tool kit storage well casing ④.
- ▶ Remove Minispare wheel ③.

Storing the Minispare wheel

- ▶ Place Minispare wheel ③ in wheel well.
- ▶ Place vehicle tool kit storage well casing ④ over the Minispare wheel.

Make sure arrow ② on vehicle tool kit storage well casing ④ points in the direction of travel.
- ▶ Place storage well casing (▷ page 300) over vehicle tool kit storage well casing ④ and turn the retaining screw (▷ page 300) clockwise as far it will go to secure the Minispare wheel.



Arrow ② on vehicle tool kit storage well casing ④ must point in the direction of travel. Otherwise you cannot place the storage well casing (▷ page 300) on top and secure the Minispare wheel with the retaining screw (▷ page 300).

Practical hints

Where will I find ...?



To prevent damage, always disengage trunk floor handle from upper edge of trunk and lower trunk floor before closing the trunk lid.

Warning!



The dimensions of the Minispare wheel are different from those of the road wheels. As a result, the vehicle handling characteristics change when driving with a Minispare wheel mounted.

The Minispare wheel should only be used temporarily, and should be replaced with a regular road wheel as quickly as possible.

Practical hints

Where will I find ...?

In the case of a flat tire, you may temporarily use the Minispare wheel when observing the following restrictions:

- Do not exceed a vehicle speed of 50 mph (80 km/h).
- Drive to the nearest tire repair facility to have the flat tire repaired or replaced as appropriate.
- Do not operate vehicle with more than one Minispare wheel mounted.

For more information, see “Rims and Tires” (▷ page 342).

Minispare wheel bolts

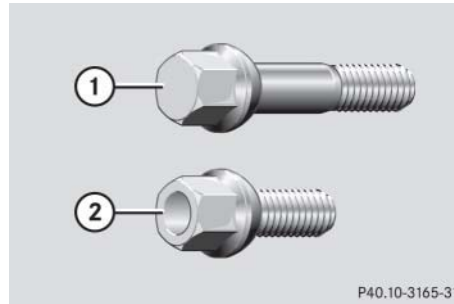

- ① Wheel bolt for light alloy rims
- ② Wheel bolt for Minispare wheel or other steel rims (located in trunk with spare wheel)



Wheel bolts ② must be used when mounting the Minispare wheel or other steel rims. The use of any wheel bolts other than wheel bolts ② for the Minispare wheel or other steel rims will physically damage the vehicle's brakes.

Warning!



Make sure to use the original length wheel bolts when remounting the original wheel after it has been repaired.

Practical hints

Unlocking/locking in an emergency

▼ Unlocking/locking in an emergency

Unlocking the vehicle



If you are unable to unlock the vehicle with the SmartKey, open the driver's door and the trunk using the mechanical key.

The passenger door cannot be unlocked manually.



Unlocking your vehicle with the mechanical key will trigger the anti-theft alarm system.

To cancel the alarm, do one of the following:

- Press button  or  on the SmartKey.
- Insert the SmartKey in the starter switch.



- ① Mechanical key locking tab
- ② Mechanical key

- ▶ Move locking tab ① in direction of arrow and slide mechanical key ② out of the housing.

Unlocking the driver's door

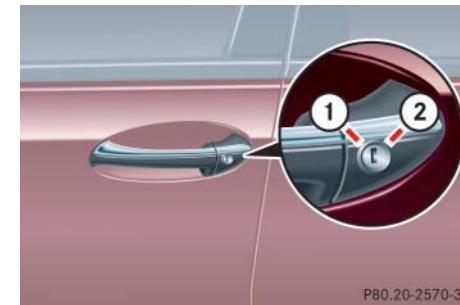

- ① Unlocked
- ② Locked

- ▶ Unlock the door with the mechanical key. To do so, push the mechanical key in the lock until it stops and turn it to the left ①.

Practical hints

Unlocking/locking in an emergency

Unlocking the trunk

A minimum height clearance of 5.71 ft (1.74 m) is required to open the trunk lid.

The lock is located next to the recessed handle.

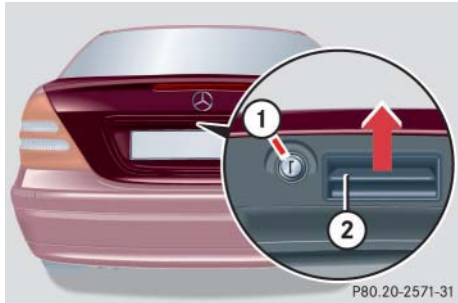

① Unlocking in an emergency

② Handle

- ▶ Slide mechanical key out of the SmartKey (▷ page 305).
- ▶ Insert the mechanical key into the trunk lid lock.

- ▶ Turn the mechanical key counterclockwise completely to position ① and hold it in this position.
- ▶ Pull trunk lid handle ② and lift the trunk lid.



Always make sure there is sufficient overhead clearance.

Locking the vehicle

If you are unable to lock the vehicle with the SmartKey, lock it with the mechanical key as follows:

- ▶ Close the passenger doors and the trunk.
- ▶ Press the central locking switch in the cockpit (▷ page 91).
- ▶ Check to see whether the locking knobs on the passenger doors are down. If necessary push them down manually.
- ▶ Slide mechanical key out of the SmartKey (▷ page 305).
- ▶ Lock the driver's door with the mechanical key (▷ page 305).
- ▶ Check if the trunk is locked. If necessary lock the trunk with the mechanical key (▷ page 89).

Practical hints

Unlocking/locking in an emergency

Changing batteries in the SmartKey

If the batteries in the SmartKey are discharged, the vehicle can no longer be locked or unlocked. It is recommended to have the batteries replaced at an authorized Mercedes-Benz Center.

Warning!



Keep the batteries out of reach of children.

If a battery is swallowed, seek medical help immediately.

Batteries contain materials that can harm the environment if disposed of improperly. Recycling of batteries is the preferred method of disposal. Many states require sellers of batteries to accept old batteries for recycling.

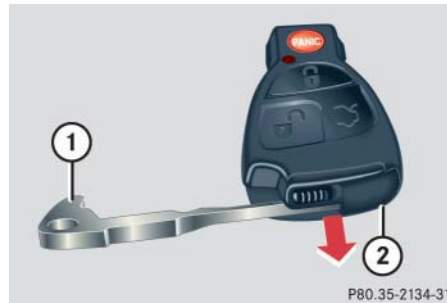

- ① Mechanical key
- ② Battery compartment

Replacement batteries: Lithium, type CR 2025 or equivalent.



When changing batteries, always replace both batteries.

The required replacement batteries are available at any Mercedes-Benz Center.

- ▶ Remove mechanical key ① (▶ page 305).

- ▶ Insert mechanical key ① in side opening and push grey slide. Battery compartment ② is unlatched.
- ▶ Pull battery compartment ② out of the SmartKey housing in direction of arrow.

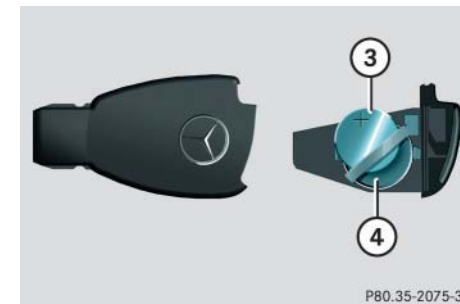

- ③ Battery
- ④ Contact spring

- ▶ Remove the batteries.
- ▶ Using a lint-free cloth, insert new batteries under contact spring with the plus (+) side facing up.
- ▶ Return battery compartment ② into housing until it locks into place. ▷▷

Practical hints

Unlocking/locking in an emergency

- ▶▶▶ Slide mechanical key ① back into the SmartKey.



When inserting the batteries, make sure they are clean and free of lint.

Fuel filler flap

In case the central locking system does not release the fuel filler flap, you can open it manually.

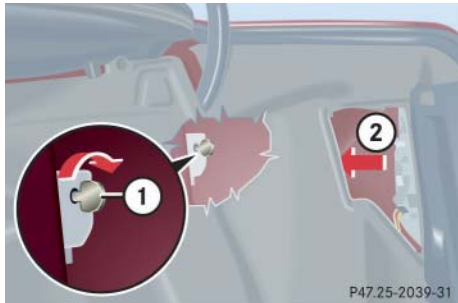

- ▶ Open the trunk lid.
- ▶ Fold away right-side tail lamp trim.

- ▶ Reach inside through opening ② in direction of arrow.
- ▶ Turn release knob ① clockwise (arrow).

The fuel filler flap can now be opened.

Manually unlocking the transmission gear selector lever

In the case of power failure the transmission gear selector lever can be manually unlocked, e.g. to tow the vehicle.

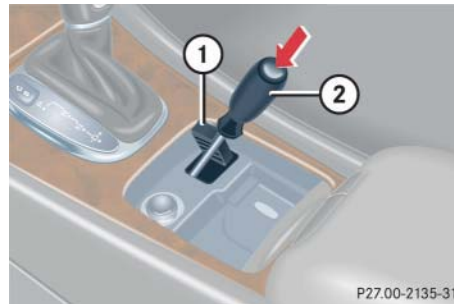

- ① Coin holder
- ② Tool

- ▶ Open the storage compartment in front of the center armrest (▶ page 218).
- ▶ Release coin holder ① (e.g. using a small coin).
- ▶ Swing coin holder ① aside.
- ▶ Insert a tool ② (e.g. flat blade screwdriver) into the opening.
- ▶ Perform the following two steps simultaneously:
 - ▶ Push tool ② down.
 - ▶ Move gear selector lever from position **P**.
- ▶ Reinstall coin holder ① after removing tool ② from the opening.



The gear selector lever is locked again when moving it to position **P**.

▼ Opening/closing in an emergency

Sliding/pop-up roof*

You can open or close the sliding/pop-up roof manually should an electrical malfunction occur.

The sliding/pop-up roof drive is located behind the lens ① of the interior overhead light.



- ▶ Pry of lens ① using a flat blade screwdriver.



- ▶ Slide both locking tabs ② in direction of arrow.
- ▶ Lower rear of cover and remove.
- ▶ Remove cover.



Do not disconnect electrical connectors.

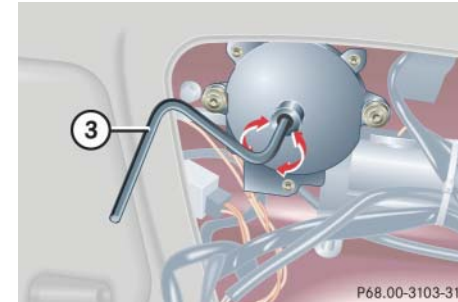

- ▶ Obtain crank ③.
- ▶ Insert crank ③ through hole.
- ▶ Turn crank ③ clockwise to:
 - slide roof closed
 - raise roof at the rear
- ▶ Turn crank ③ counterclockwise to:
 - slide roof open
 - lower roof at the rear

The sliding/pop-up roof must be resynchronized after being operated manually (▷ page 205).

Practical hints

Replacing bulbs

▼ Replacing bulbs

Safe vehicle operation depends on proper exterior lighting and signaling. It is therefore essential that all bulbs and lamp assemblies are in good working order at all times.

Correct headlamp adjustment is extremely important. Have headlamps checked and readjusted at regular intervals and when a bulb has been replaced. See your authorized Mercedes-Benz Center for headlamp adjustment.



Backup bulbs will be brought into use when the following lamps malfunction:

- Standing lamps
- Tail lamps
- Rear fog lamp

Bulbs



P54.00-2318-31

Front lamps

Lamp	Type
① Additional turn signal lamps	LED
② Turn signal lamp Halogen Turn signal lamp Bi-Xenon*	1156 A 2357 A
③ Halogen headlamps: Low beam Bi-Xenon* headlamps: Low and high beam	H7 (55 W) D2S-35 W
④ Halogen headlamps: High beam Bi-Xenon* headlamps: High beam flasher Parking and standing lamps	H7 (55 W) H7 (55 W) W 5 W
⑤ Fog lamp	HB4/9006 (55 W)
⑥ Side marker lamp	W 5 W

Rear lamps

Lamp	Type
⑦ High mounted brake lamp	LED
⑧ Brake lamp	P 21 W
⑨ Turn signal lamp	PY 21 W
⑩ Backup lamp	P 21 W
⑪ Tail, parking, standing and side marker lamp	P 21/5 W
⑫ License plate lamps	C 5 W
⑬ Rear fog lamp, driver's side	P 21/4 W

Notes on bulb replacement

Warning!



Keep bulbs out of reach of children.

Bulbs and bulb sockets can be very hot. Allow the lamp to cool down before changing a bulb.

Halogen lamps contain pressurized gas. A bulb can explode if you

- touch or move it when hot
- drop the bulb
- scratch the bulb

Wear eye and hand protection.

Because of high voltage in Xenon lamps, it is dangerous to replace the bulb or repair the lamp and its components. We recommend that you have such work done by a qualified technician.

Practical hints

Replacing bulbs

- 12 volt bulbs of the same type and with the specified watt rating.
- Switch lights off before changing a bulb to prevent short circuits.
- Always use a clean lint-free cloth when handling bulbs.
- Your hands should be dry and free of oil and grease.
- If the newly installed bulb does not come on, visit an authorized Mercedes-Benz Center.
- Have the LEDs and bulbs for the following lamps replaced by an authorized Mercedes-Benz Center:
 - Additional turn signals in the exterior rear view mirrors
 - High mounted brake lamp
 - Xenon lamps
 - Front fog lamps

Practical hints

Replacing bulbs

Replacing bulbs for front lamps

Halogen headlamps

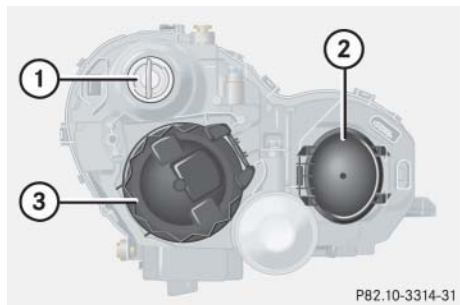

- ① Bulb socket for turn signal lamp
- ② Headlamp cover for high beam headlamp, parking and standing lamp
- ③ Headlamp cover for low beam headlamp

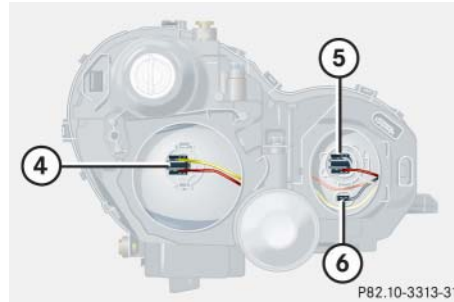

- ④ Low beam headlamp bulb
- ⑤ High beam headlamp bulb
- ⑥ Bulb socket for parking and standing lamp bulb

Low and high beam bulb

- ▶ Switch off the lights.
- ▶ Open the hood (▷ page 252).
- ▶ Press the clamp and remove headlamp cover ② or ③.
- ▶ Pull electrical connector off.
- ▶ Unclip the retainer springs and take out the bulb.

- ▶ Insert the new bulb so that the base locates in the recess on the holder.
- ▶ Clip the retainer springs and plug the connector onto the bulb.
- ▶ Align headlamp cover ② or ③ and click into place.

Front turn signal lamp bulb

- ▶ Switch off the lights.
- ▶ Open the hood (▷ page 252).
- ▶ Twist bulb socket ① counterclockwise and pull out.
- ▶ Push bulb into socket, turn counterclockwise and remove.
- ▶ Insert new bulb in socket, push in and twist clockwise.
- ▶ Reinsert bulb socket in lamp and twist clockwise.

Parking and standing lamp bulb

- ▶ Switch off the lights.
- ▶ Open the hood (▷ page 252).
- ▶ Press the clamp and remove headlamp cover ②.
- ▶ Pull out bulb socket ⑥ with the bulb.
- ▶ Pull the bulb out of bulb socket.
- ▶ Insert a new bulb in the socket.
- ▶ Reinstall bulb socket.
- ▶ Align headlamp cover ② and click into place.

Bi-Xenon* headlamps

Warning!



Do not remove the cover ③ for the Bi-Xenon headlamp. Because of high voltage in Bi-Xenon lamps, it is dangerous to replace the bulb or repair the lamp and its components. We recommend that you have such work done by a qualified technician.

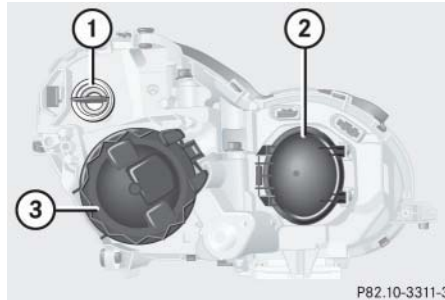

- ① Bulb socket for turn signal lamp
- ② Headlamp cover for high beam flasher, parking and standing lamp
- ③ Cover for Bi-Xenon lamp

Practical hints

Replacing bulbs

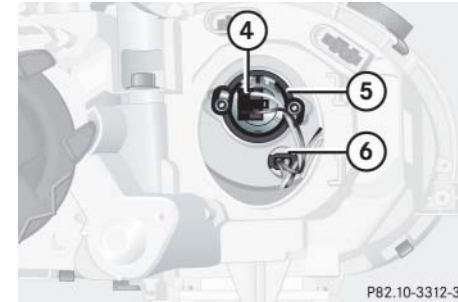

- ④ High beam flasher bulb
- ⑤ Bayonet socket for high beam flasher bulb
- ⑥ Bulb socket for parking and standing lamp bulb

High beam bulb

- ▶ Switch off the lights.
- ▶ Open the hood (▷ page 252).
- ▶ Press the clamp and remove lamp cover ②.
- ▶ Pull electrical connector ④ off. ▷▷

Practical hints

Replacing bulbs

- ▷▷ Twist bayonet socket ⑤ counterclockwise to the stop (do not remove).
- ▶ Pull the bulb out of the socket.
- ▶ Insert the new bulb so that the base locates in the recess in bayonet socket ⑤.
- ▶ Twist bayonet socket clockwise until you hear it snap into place.
- ▶ Plug the connector onto the bulb.
- ▶ Align lamp cover ② and click into place.

Front turn signal lamp bulb

- ▶ Switch off the lights.
- ▶ Open the hood (▷ page 252).
- ▶ Twist bulb socket ① counterclockwise and pull out.
- ▶ Push bulb into socket, turn counterclockwise and remove.

- ▶ Insert new bulb in socket, push in and twist clockwise.
- ▶ Reinsert bulb socket in lamp and twist clockwise.

Parking and standing lamp bulb

- ▶ Switch off the lights.
- ▶ Open the hood (▷ page 252).
- ▶ Press the clamp and remove headlamp cover ②.
- ▶ Pull out bulb socket ⑥ with the bulb.
- ▶ Pull the bulb out of bulb socket.
- ▶ Insert a new bulb in the socket.
- ▶ Reinstall bulb socket.
- ▶ Align headlamp cover ② and click into place.

Side marker lamp bulb

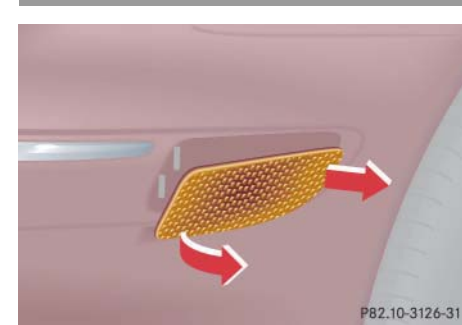

- ▶ Switch off the lights.
- ▶ Carefully slide lamp towards rear.
- ▶ Remove front end first.
- ▶ Twist bulb socket counterclockwise and pull out.
- ▶ Pull bulb out of the bulb socket.
- ▶ Insert new bulb in socket.
- ▶ Reinstall bulb socket, push in and twist clockwise.
- ▶ To reinstall lamp, set rear end in bumper and let front end snap into place.

Practical hints

Replacing bulbs

Replacing bulbs for rear lamps

Tail lamp assemblies

- ▶ Switch off lights.
- ▶ Open trunk lid.



- ① Locking lever
- ▶ Fold trim to the side.
- ▶ Turn locking lever ① to vertical position and remove bulb carrier.

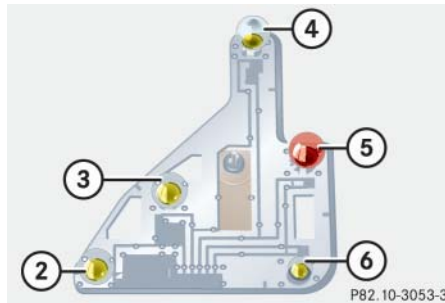

- ② Rear fog lamp, driver's side
- ③ Back up lamp
- ④ Stop lamp
- ⑤ Turn signal lamp
- ⑥ Tail, parking, standing and side marker lamp
- ▶ Gently push bulb into socket, turn counterclockwise and pull out.
- ▶ Insert new bulb and turn clockwise.
- ▶ Reinstall bulb socket.
- ▶ Reinstall bulb holder and close trim panel.

License plate lamp

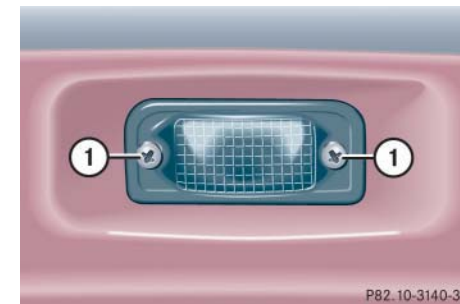

- ① Screw
- ▶ Switch off the lights.
- ▶ Loosen both screws ① and remove lamp.
- ▶ Replace the tubular lamp and reinstall lamp.
- ▶ Retighten the screws.

Practical hints

Replacing wiper blades

▼ Replacing wiper blades

Removing wiper blades

Warning!



For safety reasons, remove SmartKey from starter switch before replacing a wiper blade. Otherwise the motor could suddenly turn on and cause injury.

- ▶ Fold the wiper arm forward.

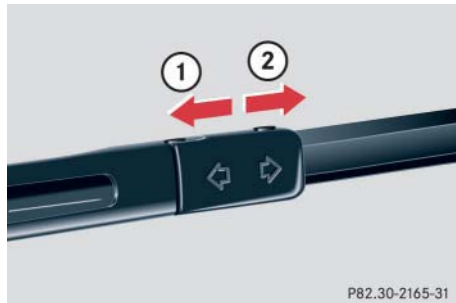

- ① Lock
- ② Unlock

- ▶ Pull the tab in direction of arrow ② and remove windshield wiper.

Installing wiper blades

- ▶ Slide the wiper blade into the cutout on the wiper arm.
- ▶ Slide the tab back in the direction of arrow ① until it audibly engages.
- ▶ Fold the wiper arm backward to rest on the windshield. Make sure you hold on to the wiper when folding the wiper arm back.



Never open the hood when the wiper arms are folded forward.

Hold on to the wiper when folding the wiper arm back. If released, the force of the impact from the tensioning spring could crack the windshield.

Do not allow the wiper arms to contact the windshield glass without a wiper blade inserted.

Make certain that the wiper blades are properly installed. Improperly installed wiper blades may cause windshield damage.

For your convenience, we recommend that you have this work carried out by an authorized Mercedes-Benz Center.

▼ Flat tire

Preparing the vehicle

- ▶ Park the vehicle as far as possible from moving traffic on a hard surface.
- ▶ Turn on the hazard warning flashers.
- ▶ Engage the steering wheel lock in the straight ahead position and set the parking brake.
- ▶ Move the gear selector lever to **P** (manual transmission to first or reverse gear).
- ▶ Have any passenger exit the vehicle at a safe distance from the roadway.

Mounting the Minispare wheel

Warning!



The dimensions of the Minispare wheel are different from those of the road wheels. As a result, the vehicle handling characteristics change when driving with a Minispare wheel mounted.

The spare wheel should only be used temporarily, and replaced with a regular road wheel as quick as possible.

In the case of a flat tire, you may temporarily use the Minispare wheel when observing the following restrictions:

- Do not exceed vehicle speed of 50 mph (80 km/h).
- Drive to the nearest tire repair facility to have the flat tire repaired or replaced as appropriate.
- Do not operate vehicle with more than one spare wheel mounted.

Preparing the vehicle

Prepare the vehicle as described on (▷ page 317).

- ▶ Take the wheel wrench and the jack out of the vehicle tool kit storage well casing underneath the trunk floor (▷ page 300).
- ▶ Take the Minispare wheel and wheel bolts out of the storage compartment underneath the trunk floor (▷ page 302).

Lifting the vehicle

- ▶ Prevent the vehicle from rolling away by blocking wheels with wheel chocks (not included) or other sizable objects.

When changing wheel on a level surface:

- ▶ Place one chock in front of and one behind the wheel that is diagonally opposite to the wheel being changed.

When changing wheel on a hill:

- ▶ Place chocks on the downhill side blocking both wheels of the other axle.

Practical hints

Flat tire

Warning!



The jack is designed exclusively for jacking up the vehicle at the jack take-up brackets built into both sides of the vehicle. To help avoid personal injury, use the jack only to lift the vehicle during a wheel change. Never get beneath the vehicle while it is supported by the jack. Keep hands and feet away from the area under the lifted vehicle. Always firmly set parking brake and block wheels before raising vehicle with jack.

Do not disengage parking brake while the vehicle is raised. Be certain that the jack is always vertical (plumb line) when in use, especially on hills. Always try to use the jack on level surface. Make sure the jack arm is fully seated in the jack take-up bracket. Always lower the vehicle onto sufficient capacity jackstands before working under the vehicle.



Wheel cover on vehicles with steel rims (Canada only)

- ▶ On wheel to be changed, remove wheel cover by reaching into two openings of the wheel cover and pulling away from the wheel.

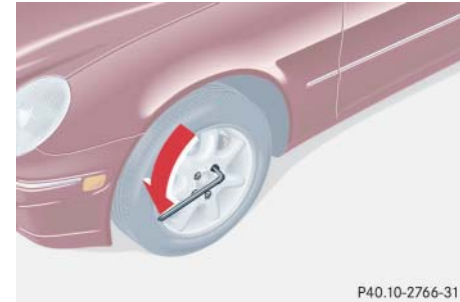

- ▶ On wheel to be changed, loosen but do not yet remove the wheel bolts (approximately one full turn with wrench).

Practical hints

Flat tire

The jack take-up brackets are located directly behind the front wheel housings and in front of the rear wheel housings.

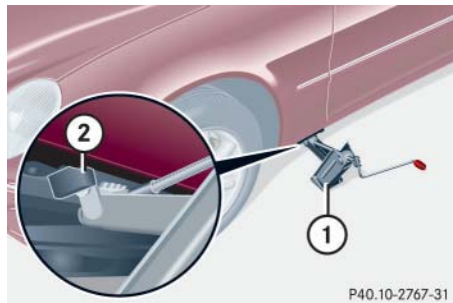

- ① Jack
- ② Take-up bracket

- ▶ Place jack ① on firm ground.
- ▶ Position jack ① under take-up bracket ② so that it is always vertical (plumb-line) as seen from the side, even if the vehicle is parked on an incline.

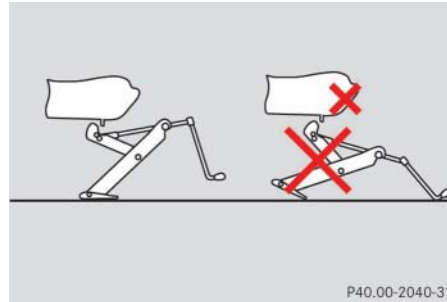

- ▶ Jack up the vehicle until the wheel is a maximum of 1.2 in (3 cm) from the ground. Never start engine while vehicle is raised.

Warning!



The jack is intended only for lifting the vehicle briefly for wheel changes. It is not suited for performing maintenance work under the vehicle.

- Never start the engine when the vehicle is raised.
- Never lie down under the raised vehicle.

Removing the wheel



- ① Alignment bolt
- ▶ Unscrew upper-most wheel bolt and remove.
- ▶ Replace this wheel bolt with alignment bolt ① supplied in the tool kit.
- ▶ Remove the remaining bolts.



Do not place wheel bolts in sand or dirt. This could result in damage to the bolts and wheel hub threads.

- ▶ Remove the wheel.

Practical hints

Flat tire

Mounting the new wheel

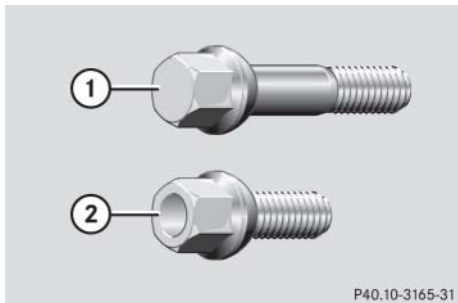

- ① Wheel bolt for light alloy rims
- ② Wheel bolt for Minispare wheel or other steel rims (located in trunk with spare wheel)



Wheel bolts ② must be used when mounting the Minispare wheel or other steel rims. The use of any wheel bolts other than wheel bolts ② for the Minispare wheel or other steel rims will physically damage the vehicle's brakes.

- ▶ Clean contact surfaces of wheel and wheel hub.



To avoid paint damage, place wheel flat against hub and hold it there while installing first wheel bolt.

Warning!



Always replace wheel bolts that are damaged or rusted.

Never apply oil or grease to wheel bolts.

Damaged wheel hub threads should be repaired immediately. Do not continue to drive under these circumstances! Contact an authorized Mercedes-Benz Center or call Roadside Assistance.

Incorrect wheel bolts or improperly tightened wheel bolts can cause the wheel to come off. This could cause an accident. Make sure to use the correct mounting bolts.

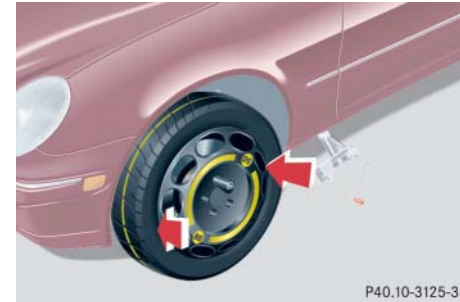

- ▶ Guide Minispare wheel onto the alignment bolt and push it on.
- ▶ Insert wheel bolts and tighten them slightly.

Practical hints

Flat tire



- ▶ Unscrew the alignment bolt, install last wheel bolt and tighten slightly.

Warning!



Only use genuine equipment Mercedes-Benz wheel bolts. Other wheel bolts may come loose.

Do not tighten the wheel bolts when the vehicle is raised. Otherwise the vehicle could tip over.

Lowering the vehicle

- ▶ Lower vehicle by turning crank counterclockwise until vehicle is resting fully on its own weight.
- ▶ Remove the jack.

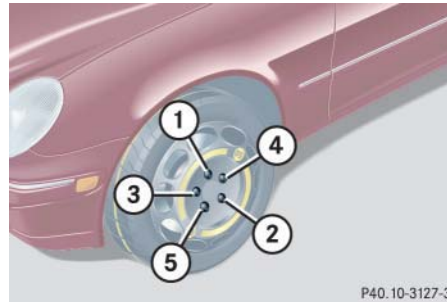

① - ⑤ Wheel bolts

- ▶ Tighten the five wheel bolts evenly, following the diagonal sequence illustrated (① to ⑤), until all bolts are tight. Observe a tightening torque of 80 lb-ft (110 Nm).

Warning!



Have the tightening torque checked after changing a wheel. The wheels could come loose if they are not tightened to a torque of 80 lb-ft (110 Nm).

Before storing the jack, it should be fully collapsed, with handle folded in (storage position) (▷ page 302).

- ▶ Store the jack and the other vehicle tools in the vehicle tool kit storage well casing (▷ page 303).
- ▶ Store the wheel cover (Canada only) and the damaged wheel in the trunk.

Practical hints

Flat tire

Mounting wheel cover (Canada only)



The wheel cover does not fit the Minispare wheel.



Wheel cover on vehicles with steel rims
(Canada only)

- ▶ Position small wheel cover opening over tire valve and press wheel cover against wheel rim.
- ▶ Now press (do not hit) opposite side of wheel cover against wheel rim until seated.

Make certain that the springs of the wheel cover are firmly seated in the outer rim of the steel wheel.

▼ Battery

The battery is located in the engine compartment on the right hand side.

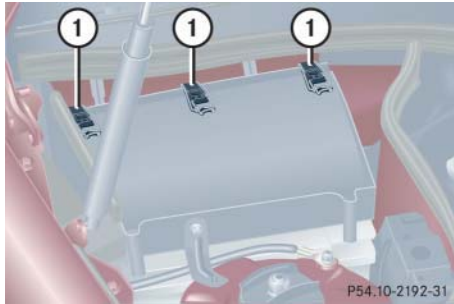

Removal of filter box:

- ▶ Release the three clamps ①.
- ▶ Remove filter box.

Installation of filter box:

- ▶ Insert filter box properly.
- ▶ Secure it with the three clamps ①.

Warning!



Failure to follow these instructions can result in severe injury or death.

Never lean over batteries while connecting, you might get injured.

Battery fluid contains sulfuric acid. Do not allow this fluid to come in contact with eyes, skin or clothing. In case it does, immediately flush affected area with water and seek medical help if necessary.

A battery will also produce hydrogen gas, which is flammable and explosive. Keep flames or sparks away from battery, avoid improper connection of jumper cables, smoking, etc.

Practical hints

Battery



Never loosen or detach battery terminal clamps while the engine is running or the SmartKey is in the starter switch. Otherwise the alternator and other electronic components could be severely damaged.

Have the battery checked regularly by an authorized Mercedes-Benz Center.

Refer to Service Booklet for maintenance intervals or contact your authorized Mercedes-Benz Center for further information.

Warning!



Do not place metal objects on the battery as this could result in a short circuit.

Use leak-proof battery only to avoid the risk of acid burns in the event of an accident.

Practical hints

Battery

Warning!



With a disconnected battery

- you will no longer be able to turn the SmartKey in the starter switch
- the gear selector lever will remain locked in position **P**

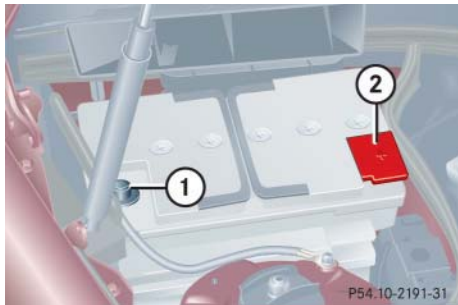

- ① Negative terminal
- ② Positive terminal cover

Disconnecting the battery

- ▶ Turn off all electrical consumers.
- ▶ Open the hood (▷ page 252).
- ▶ Remove the filter box (▷ page 323).
- ▶ Disconnect battery negative lead ①.
- ▶ Remove cover ② from positive terminal.
- ▶ Disconnect the battery positive lead.

Removing the battery

- ▶ Remove the screw-nuts securing the battery.
- ▶ Remove the battery bracket.
- ▶ Take out the battery.

Charging and reinstalling the battery

- ▶ Charge battery in accordance with the instructions of the battery charger manufacturer.
- ▶ Reinstall the charged battery. Follow the previously described steps in reverse order.

Warning!



Never charge a battery while still installed in the vehicle. Gases may escape during charging and cause explosions that may result in paint damage, corrosion or personal injury.

Reconnecting the battery

- ▶ Turn off all electrical consumers.
- ▶ Connect the positive lead and fasten its cover ②.
- ▶ Connect negative lead ①.



NEVER invert the terminal connections!

- ▶ Reinstall the filter box (▷ page 323).



The battery, its filler caps and the vent tube must always be securely installed when the vehicle is in operation.



The following procedures must be carried out following any interruption of battery power (e.g. due to reconnection):

- Set the clock (▷ page 126).
Vehicles with COMAND*:
See COMAND operator's manual.
- Resynchronize the ESP (▷ page 282).
- Resynchronize side windows (▷ page 202).
- Resynchronize sliding/pop-up roof* (▷ page 205).

Batteries contain materials that can harm the environment if disposed of improperly. Large 12 volt storage batteries contain lead. Recycling of batteries is the preferred method of disposal. Many states require sellers of batteries to accept old batteries for recycling.

Practical hints

Jump starting

▼ Jump starting

Warning!



Failure to follow these directions will cause damage to the electronic components, and can lead to a battery explosion and severe injury or death.

Never lean over batteries while connecting or jump starting, you might get injured.

Battery fluid contains sulfuric acid. Do not allow this fluid to come in contact with eyes, skin or clothing. In case it does, immediately flush affected area with water, and seek medical help if necessary.

A battery will also produce hydrogen gas, which is flammable and very explosive. Keep flames or sparks away from battery, avoid improper connection of jumper cables, smoking, etc.

Attempting to jump start a frozen battery can result in it exploding, causing personal injury.

Read all instructions before proceeding.

If the battery is discharged, the engine can be started with jumper cables and the battery of another vehicle. Observe the following:

- Jump starting should only be performed when the engine and catalytic converter are cold.
- Do not start the engine if the battery is frozen. Let the battery thaw out first.
- Only jump start from batteries with the same voltage rating (12 V). Jump starting with a more powerful battery could damage the vehicle's electrical system, which will not be covered by the Mercedes-Benz Limited Warranty.
- Only use jumper cables with sufficient cross-section and insulated terminal clamps.
- Always make sure the jumper cables are not on or near pulleys, fans, or other parts that move when an engine is started or running.



Jump starting may only be performed on the battery installed in the engine compartment.

Avoid repeated and lengthy starting attempts.

Do not attempt to start the engine using a battery quick charge unit.

If engine does not run after several unsuccessful starting attempts, have it checked at the nearest authorized Mercedes-Benz Center.

Excessive unburned fuel generated by repeated failed starting attempts may damage the catalytic converter and may present a fire risk.

Make sure the jumper cables do not have loose or missing insulation.

Make sure the cable clamps do not touch any other metal part while the other end is still attached to a battery.

Warning!



Keep flames or sparks away from battery.
Do not smoke.

Observe all safety instructions and precautions when handling automotive batteries (> page 258).

The battery is located in the engine compartment on the right hand side. The terminals for jump starting are located in front of the battery.

- ▶ Make sure the two vehicles do not touch.
- ▶ Turn off all electrical consumers.
- ▶ Apply parking brake.
- ▶ Shift gear selector lever to position **P** (manual transmission to Neutral).

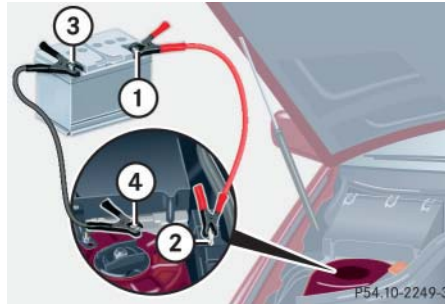

- ① Positive terminal of charged battery
 - ② Positive under hood terminal in front of discharged battery
 - ③ Negative terminal of charged battery
 - ④ Negative under hood terminal in front of discharged battery
- ▶ Connect positive terminal ① of the charged battery with positive under hood terminal ② in front of the discharged battery with the jumper cables. Clamp cable to charged battery ① first.
 - ▶ Start engine of the vehicle with the charged battery and run at idle speed.

Practical hints

Jump starting

- ▶ Connect negative terminal ③ of the charged battery with negative under hood terminal ④ of the discharged battery with the jumper cables. Clamp cable to charged battery ③ first.
- ▶ Start the engine of the disabled vehicle.

You can now again turn on the electrical consumers. Do not turn on the lights under any circumstances.

- ▶ Remove the jumper cables first from negative terminals ③ and ④ and then from positive terminals ① and ②.

You can now turn on the lights.

- ▶ Have the battery checked at the nearest authorized Mercedes-Benz Center.



Vehicles with automatic transmission and/or 4MATIC:
Do not tow-start the vehicle.

Practical hints

Towing the vehicle

▼ Towing the vehicle

Mercedes-Benz recommends that the vehicle be transported with all wheels off the ground using flatbed or appropriate wheel lift/dolly equipment. This method is preferable to other types of towing.



Use flatbed or wheel lift/dolly equipment with SmartKey in starter switch turned to position **0**.

Do not tow with sling-type equipment. Towing with sling-type equipment over bumpy roads will damage radiator and supports.

To prevent damage during transport, do not tie down vehicle by its chassis or suspension parts.

Switch off the tow-away alarm (▷ page 79) and deactivate the automatic central locking (▷ page 133).

When circumstances do not permit the recommended towing methods, the vehicle may be towed with all wheels on the ground or front wheels raised (except vehicles with 4MATIC) only so far as necessary to have the vehicle moved to a safe location where the recommended towing methods can be employed.



Vehicles with automatic transmission and/or 4MATIC:
Do not tow-start the vehicle.



Vehicles with 4MATIC:
Do not tow with one axle raised. Doing so could damage the transfer case, which is not covered by the Mercedes-Benz Limited Warranty.

All wheels must be on or off the ground. Observe instructions for towing the vehicle with all wheels on the ground.



If the vehicle is towed with the front axle raised (not permissible for vehicles with 4MATIC), the engine must be shut off (SmartKey in starter switch position **0** or **1**). Otherwise the ESP will immediately be engaged and will apply the rear wheel brakes.

When towing the vehicle with all wheels on the ground, the gear selector lever must be in position **N** (manual transmission: gears disengaged) and the SmartKey must be in starter switch position **2**.

When towing the vehicle with all wheels on the ground or the front axle raised, the vehicle may be towed only for distances up to 30 miles (50 km) and at a speed not to exceed 30 mph (50 km/h).



To be certain to avoid a possibility of damage to the drive train, however, we recommend the drive shaft be disconnected at the rear axle drive flange (vehicles with 4MATIC: disconnected at the front and rear axle drive flanges) for any towing beyond a short tow to a nearby garage.

Warning!



If circumstances require towing the vehicle with all wheels on the ground, always tow with a tow bar if:

- the engine will not run
- there is a malfunction in the power supply or in the vehicle's electrical system

as that will be necessary to adequately control the towed vehicle.

Prior to towing the vehicle with all wheels on the ground, make certain that the SmartKey is in starter switch position **2**.

If the SmartKey is left in starter switch position **0** for an extended period of time, it can no longer be turned in the switch. In this case, the steering is locked. To unlock, remove SmartKey from starter switch and reinsert.

Practical hints

Towing the vehicle



To signal turns while being towed with the hazard warning flasher in use, turn SmartKey in starter switch to position **2** and activate the combination switch for the left or right turn signal in the usual manner – only the selected turn signal will operate.

Upon canceling the turn signal, the hazard warning flasher will operate again.

Practical hints

Towing the vehicle

Warning!



With the engine not running, there is no power assistance for the brake and steering systems. In this case, it is important to keep in mind that a considerably higher degree of effort is necessary to brake and steer the vehicle. Adapt your driving accordingly.



When towing the vehicle with all wheels on the ground, please note the following:

With the automatic central locking activated and the SmartKey in starter switch position **2**, the vehicle doors lock if the left front wheel as well as the right rear wheel are turning at vehicle speeds of approx. 9 mph (15 km/h) or more.

Switch off the tow-away alarm (▷ page 79).

To prevent the vehicle doors from locking, deactivate the automatic central locking (▷ page 133).

Towing of the vehicle should only be done using the properly installed towing eye bolt. Never attach tow cable, tow rope or tow rod to vehicle chassis, frame or suspension parts.



If the battery is disconnected or discharged

- the SmartKey will not turn in the starter switch. See notes on the battery (▷ page 323) or on jump starting (▷ page 326).
- the gear selector lever will remain locked in position **P**. See notes on manually unlocking transmission gear selector lever (▷ page 308).

Installing towing eye bolt

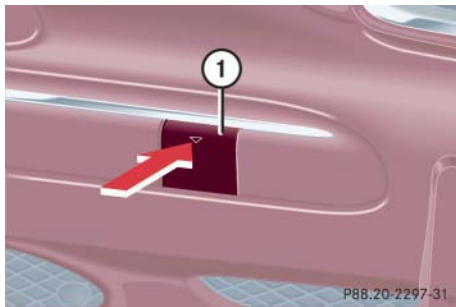

① Cover on right side of front bumper.



② Cover on right side of rear bumper.

Practical hints

Towing the vehicle

Removing cover

- ▶ Press mark on cover in direction of arrow.
- ▶ Lift cover off to reveal threaded hole for towing eye bolt.

The towing eye bolt is supplied with the tool kit (located in the compartment underneath the trunk floor).

- ▶ Screw towing eye bolt in to its stop and tighten with lug wrench.

Reinstalling cover

- ▶ Fit cover and snap into place.

Practical hints

Fuses

▼ Fuses



Only install fuses that have been tested and approved by Mercedes-Benz and that have the specified amperage rating.

Never attempt to repair or bridge a blown fuse. Have the cause determined and remedied by an authorized Mercedes-Benz Center.

Fuse box in passenger compartment



① Cover

Opening

- ▶ Pull cover ① open with a screw driver or similar tool.
- ▶ Remove cover rearward.

Closing

- ▶ Attach cover ① in the front.
- ▶ Fold cover in until it engages.

Fuse chart

The fuse chart is found in the fuse box in the passenger compartment. The amperages of the fuses are also given there.

Fuse box in engine compartment

The fuse box is located in the engine compartment on the left hand side.

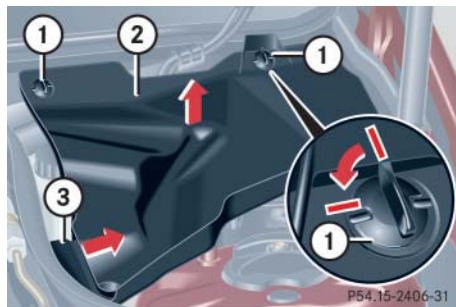

- ① Screw
- ② Cover
- ③ Retainer

Removing/installing cover

- ▶ Twist screws ① 90° counterclockwise.
- ▶ Pull up cover ②.
- ▶ Slide out retainer ③ and remove cover by pulling towards front.
- ▶ Install cover ② in reverse order.

Opening fuse box

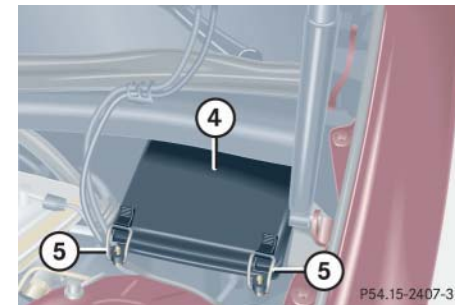

- ④ Fuse box cover
- ⑤ Clamps

- ▶ Release clamps ⑤.
- ▶ Remove cover ④.

Closing fuse box

- ▶ Ensure that the sealing rubber is properly positioned.
- ▶ Press cover ④ down and secure with clamps ⑤.

Practical hints

Fuses

Auxiliary fuse box in trunk

The auxiliary fuse box is located in the trunk.

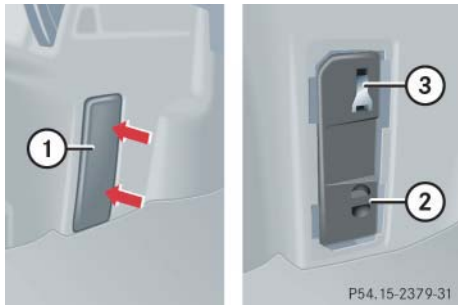

- ① Trim panel
- ② Cover of auxiliary fuse box
- ③ Special fuse extractor

Opening

- ▶ Pull away trim panel ①.
- ▶ Remove cover ②.

Spare fuses

Spare fuses are found in the vehicle tool kit in the spare wheel well.

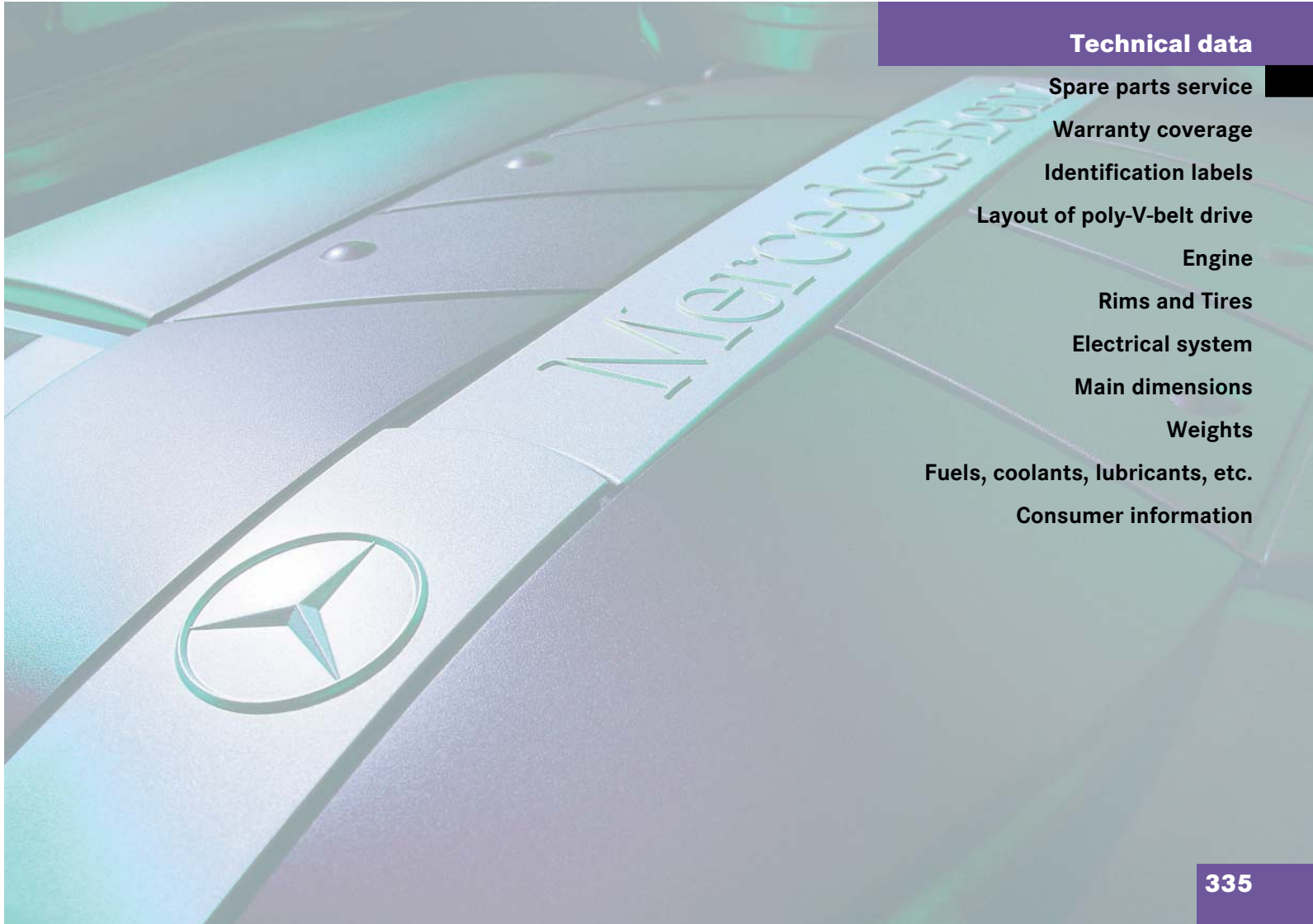

Technical data

- Spare parts service
- Warranty coverage
- Identification labels
- Layout of poly-V-belt drive
 - Engine
 - Rims and Tires
- Electrical system
- Main dimensions
- Weights
- Fuels, coolants, lubricants, etc.
- Consumer information

Technical data

Spare parts service

The “Technical data” section provides the necessary technical data for your vehicle.

▼ Spare parts service

All authorized Mercedes-Benz Centers maintain a stock of genuine Mercedes-Benz parts required for maintenance and repair work. In addition, strategically located parts distribution centers provide quick and reliable parts service.

More than 300 000 different spare parts for Mercedes-Benz models are available.

Genuine Mercedes-Benz parts are subject to stringent quality inspections. Each part has been specifically developed, manufactured or selected for and adapted to Mercedes-Benz vehicles.

Therefore, genuine Mercedes-Benz parts should be installed.



The use of non-genuine Mercedes-Benz parts and accessories not authorized by Mercedes-Benz could damage the vehicle, which is not covered by the Mercedes-Benz Limited Warranty, or could compromise the vehicle's durability or safety.

▼ **Warranty coverage**

Your vehicle is covered under the terms of the “warranties” printed in the Service and Warranty Information booklet. Your authorized Mercedes-Benz Center will exchange or repair any defective parts originally installed in the vehicle in accordance with the terms of the following warranties:

- New Vehicle Limited Warranty
- Emission System Warranty
- Emission Performance Warranty
- California, Maine, Massachusetts, and Vermont Emission Control Systems Warranty

Replacement parts and accessories are covered by the Mercedes-Benz Spare Parts and Accessories warranties, copies of which are available at any Mercedes-Benz Center.

Loss of Service and Warranty Information Booklet

Should you lose your Service and Warranty Information booklet, have your authorized Mercedes-Benz Center arrange for a replacement. It will be mailed to you.

Technical data

Identification labels

▼ Identification labels

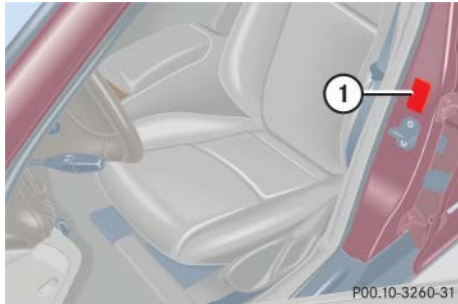

① Certification label



② Vehicle Identification Number (VIN)

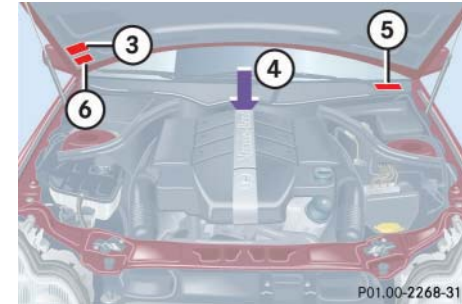

- ③ Information label, California version Vacuum line routing for emission control system
- ④ Engine number (engraved on engine)
- ⑤ VIN, visible (lower edge of windshield)
- ⑥ Emission control label

When ordering spare parts, please specify vehicle identification and engine numbers.

▼ Layout of poly-V-belt drive

C 230 Kompressor Sport

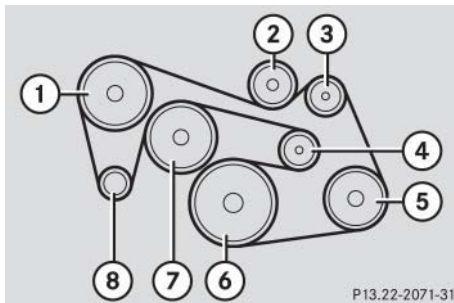

- ① Power steering pump
- ② Idler pulley
- ③ Supercharger
- ④ Automatic belt tensioner
- ⑤ Air conditioning compressor
- ⑥ Crankshaft
- ⑦ Coolant pump
- ⑧ Generator (alternator)

C 240/C 320 (all models)

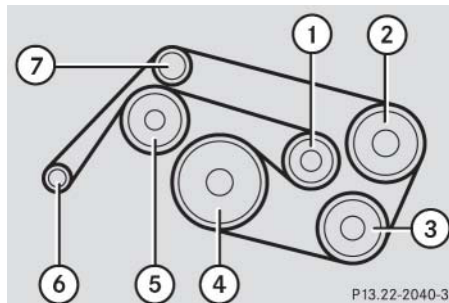

- ① Automatic belt tensioner
- ② Power steering pump
- ③ Air conditioning compressor
- ④ Crankshaft
- ⑤ Coolant pump
- ⑥ Generator (alternator)
- ⑦ Idler pulley

C 32 AMG

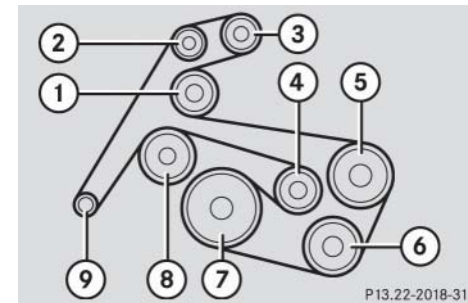

- ① Idler pulley
- ② Idler pulley
- ③ Supercharger
- ④ Automatic belt tensioner
- ⑤ Power steering pump
- ⑥ Air conditioning compressor
- ⑦ Crankshaft
- ⑧ Coolant pump
- ⑨ Generator (alternator)

Technical data

Engine

▼ Engine

Model	C 230 Kompressor Sport (203.040) ¹	C 240 (203.061) ¹ C 240 4MATIC (203.081) ¹
Engine	271	112
Mode of operation	4-stroke engine, gasoline injection	4-stroke engine, gasoline injection
No. of cylinders	4	6
Bore	3.23 in (82.00 mm)	3.54 in (89.90 mm)
Stroke	3.35 in (85.00 mm)	2.68 in (68.20 mm)
Total piston displacement	109.6 cu in (1796 cm ³)	158.5 cu in (2597 cm ³)
Compression ratio	8.5:1	10.5:1
Output acc. to SAE J 1349	189 hp/5800 rpm (141 kW/5800 rpm)	168 hp/5500 rpm (125 kW/5500 rpm)
Maximum torque acc. to SAE J 1349	192 lb-ft/3500 - 4000 rpm (260 Nm/3500 - 4000 rpm)	177 lb-ft/4500 rpm (240 Nm/4500 rpm)
Maximum engine speed	6000 rpm	6200 rpm
Firing order	1-3-4-2	1-4-3-6-2-5
Poly-V-belt	2420 mm	2380 mm

¹ The quoted data apply only to the standard vehicle. See an authorized Mercedes-Benz Center for the corresponding data of all special bodies and special equipment.

Technical data

Engine

Model	C 320 (203.064) ¹ C 320 4MATIC (203.084) ¹ C 320 Sport (203.064) ¹	C 32 AMG (203.065) ¹
Engine	112	112
Mode of operation	4-stroke engine, gasoline injection	4-stroke engine, gasoline injection
No. of cylinders	6	6
Bore	3.54 in (89.90 mm)	3.54 in (89.90 mm)
Stroke	3.31 in (84.00 mm)	3.31 in (84.00 mm)
Total piston displacement	195.2 cu in (3 199 cm ³)	195.2 cu in (3 199 cm ³)
Compression ratio	10:1	9:1
Output acc. to SAE J 1349	215 hp/5700 rpm (160 kW/5700 rpm)	349 hp/6 100 rpm (260 kW/6 100 rpm)
Maximum torque acc. to SAE J 1349	229 lb-ft/3000 - 4600 rpm (310 Nm/3000 - 4600 rpm)	332 lb-ft/4400 rpm (450 Nm/4400 rpm)
Maximum engine speed	6000 rpm	6200 rpm
Firing order	1-4-3-6-2-5	1-4-3-6-2-5
Poly-V-belt	2380 mm	2908 mm

¹ The quoted data apply only to the standard vehicle. See an authorized Mercedes-Benz Center for the corresponding data of all special bodies and special equipment.

Technical data

Rims and Tires

▼ Rims and Tires

Only use tires and rims which have been specifically developed for your vehicle and tested and approved by Mercedes-Benz. Other tires and rims can have detrimental effects, such as

- poor handling characteristics
- increased noise
- increased fuel consumption



Moreover, tires and rims not approved by Mercedes-Benz may, under load, exhibit dimensional variations and different tire deformation characteristics that could cause them to come into contact with the vehicle body or axle parts. Damage to the tires or the vehicle may be the result.



Further information on tires and rims is available at any authorized Mercedes-Benz Center. A tire inflation pressure table is located on the fuel filler flap of the vehicle. The tire pressure should be checked regularly and should only be adjusted on cold tires. Follow tire manufacturer's maintenance recommendation included with vehicle.

Technical data

Rims and Tires

Same size tires

Model	C 240 C 240 4MATIC C 320 C 320 4MATIC	C 230 Kompressor Sport C 320 Sport	C 230 Kompressor Sport C 320 Sport	C 32 AMG
Rims (light alloy)	7 J x 16 H2	7 ¹ / ₂ J x 17	7 ¹ / ₂ J x 17	-
Rims (steel - Canada only)	7 J x 16 H2	-	-	-
Wheel offset	1.46 in (37 mm)	1.42 in (36 mm)	1.46 in (37 mm)	-
All-season tires (radial-ply tires)	205/55 R16 91H	-	-	-
Summer tires (radial-ply tires)	-	-	225/45 R17 91W ¹	-
Winter tires (radial-ply tires)	205/55 R16 91H M+S	225/45 R17 91H M+S	225/45 R17 91H M+S	205/50 R17 89H M+S ² or 225/45 R17 91H M+S ^{1, 2}

¹ Must not be used with snow chains.

² Only on rim 7¹/₂ J x 17 H2

Technical data

Rims and Tires

Mixed size tires

Model	C 230 Kompressor Sport C 320 Sport	C 32 AMG
Front axle:		
Rims (light alloy)	7 ¹ / ₂ J x 17 H2	7 ¹ / ₂ J x 17 H2
Wheel offset	1.42 in (36 mm)	1.46 in (37 mm)
Summer tires (radial-ply tires)	225/45 R17 91W or 225/45 R17 91Y	225/45 R17 91Y ¹ or 225/45 ZR17 91Y ¹
Rear axle:		
Rims (light alloy)	8 ¹ / ₂ J x 17 H2	8 ¹ / ₂ J x 17 H2
Wheel offset	1.34 in (34 mm)	1.34 in (34 mm)
Summer tires (radial-ply tires)	245/40 R17 91W ¹ or 245/40 R17 91Y ¹	245/40 R17 91Y ¹ or 245/40 ZR17 91Y ¹

¹ Must not be used with snow chains.

Technical data

Rims and Tires

Minispare wheel

Model	C 240 C 240 4MATIC C 320 C 320 4MATIC	C 230 Kompressor Sport C 320 Sport C 32 AMG
Rim (steel)	3.5 B x 16 H2	3.5 B x 17 H2
Wheel offset	0.67 in (17 mm)	0.67 in (17 mm)
Tire	T 125/90 R16 98M ¹	T 125/80 R17 99M ¹

¹ Must not be used with snow chains.

Technical data

Electrical system

▼ Electrical system

Model	C 230 Kompressor Sport	C 240/C 320 (all models)	C 32 AMG
Generator (alternator)	14 V/120 A	14 V/120 A	14 V/120 A
Starter motor	12 V/1.1 kW	12 V/1.7 kW	12 V/1.7 kW
Battery	12 V/100 Ah	12 V/100 Ah	12 V/100 Ah
Spark plugs	Bosch F 6 MPP 332	Bosch F 8 DPP 332 NGK PFR 5 R-11	NGK IFR 6 D 10
Electrode gap	0.031 in (0.8 mm)	0.039 in (1.0 mm)	0.039 in (1.0 mm)
Tightening torque	18 – 22 lb-ft (25 – 30 Nm)	15 – 22 lb-ft (20 – 30 Nm)	15 – 22 lb-ft (20 – 30 Nm)

Technical data

Main dimensions

▼ Main dimensions

Model	C 230 Kompressor Sport	C 240 C 320	C 320 Sport
Overall vehicle length	178.3 in (4528 mm)	178.3 in (4528 mm)	178.3 in (4528 mm)
Overall vehicle width	68.0 in (1728 mm)	68.0 in (1728 mm)	68.0 in (1728 mm)
Overall vehicle height	56.4 in (1433 mm)	56.3 in (1429 mm)	55.6 in (1411 mm)
Wheelbase	106.9 in (2715 mm)	106.9 in (2715 mm)	106.9 in (2715 mm)
Track, front	58.8 in (1493 mm)	58.8 in (1493 mm)	58.8 in (1493 mm)
Track, rear	57.6 in (1464 mm)	57.6 in (1464 mm)	57.6 in (1464 mm)

Model	C 240 4MATIC C 320 4MATIC	C 32 AMG
Overall vehicle length	178.3 in (4528 mm)	178.3 in (4528 mm)
Overall vehicle width	68.0 in (1728 mm)	68.0 in (1728 mm)
Overall vehicle height	56.0 in (1422 mm)	56.1 in (1426 mm)
Wheelbase	106.9 in (2715 mm)	106.9 in (2715 mm)
Track, front	58.8 in (1493 mm)	58.8 in (1493 mm)
Track, rear	57.6 in (1464 mm)	58.0 in (1474 mm)

Technical data

Weights

▼ Weights

Roof load max.	220 lb (100 kg)
Trunk load max.	220 lb (100 kg)

▼ Fuels, coolants, lubricants, etc.

Capacities

Vehicle components and their respective

lubricants must match. Therefore only use brands tested and approved by Mercedes-Benz.

Please refer to the Factory Approved Service Products pamphlet, or inquire at your Mercedes-Benz Center.

	Model	Capacity	Fuels, coolants, lubricants, etc.
Engine with oil filter	C 230 Kompressor Sport	5.8 US qt (5.5 l)	Approved engine oils
	C 240	7.9 US qt (7.5 l)	
	C 320	7.9 US qt (7.5 l)	
	C 320 Sport	7.9 US qt (7.5 l)	
	C 240 4MATIC	7.4 US qt (7.0 l)	
	C 320 4MATIC	7.4 US qt (7.0 l)	
	C 32 AMG	7.9 US qt (7.5 l)	
Automatic transmission		8.5 US qt (8.0 l)	MB Automatic Transmission Oil
Manual transmission		1.3 US qt (1.2 l)	MB Manual Transmission Oil
Rear axle	C 230 Kompressor Sport	1.2 US qt (1.1 l)	Hypoid gear oil SAE 85 W 90
	C 240 (all models)	1.2 US qt (1.1 l)	
	C 320 (all models)	1.2 US qt (1.1 l)	
	C 32 AMG	1.5 US qt (1.4 l)	

Technical data

Fuels, coolants, lubricants, etc.

	Model	Capacity	Fuels, coolants, lubricants, etc.
Front axle	C 240 4MATIC C 320 4MATIC	0.5 US qt (0.46 l)	Hypoid gear oil SAE 85 W 90
Transfer case	C 240 4MATIC C 320 4MATIC	approx. 0.62 US qt (0.59 l)	MB Transfer case fluid
Power steering		approx. 1.1 US qt (1.0 l)	MB Power Steering Fluid (Pentosin CHF 11S)
Front wheel hubs		approx. 2.1 oz (60 g) each	High temperature roller bearing grease
Brake system		0.5 US qt (0.5 l)	MB Brake Fluid (DOT 4+)
Cooling system	C 230 Kompressor Sport C 240 (all models) C 320 (all models) C 32 AMG	approx. 5.9 US qt (5.6 l) approx. 6.8 US qt (6.4 l) approx. 6.8 US qt (6.4 l) approx. 6.8 US qt (6.4 l)	MB 325.0 Anticorrosion/antifreeze agent
Fuel tank including a reserve of		16.4 US gal (62.0 l) 2.1 US gal (8.0 l)	Premium unleaded gasoline: Posted Octane 91 (Avg. of 96 RON/86 MON) Flexible Fuel Vehicle (identified by a label reading Premium gasoline or E85 only! on fuel filler flap): Alternative fuel: Ethanol fuel (E85)

Technical data

Fuels, coolants, lubricants, etc.

	Model	Capacity	Fuels, coolants, lubricants, etc.
Air conditioning system			R-134a refrigerant and special PAG lubricant oil (never R-12)
Windshield washer		3.2 US qt (3.0 l)	MB Windshield Washer Concentrate ¹
Windshield washer and headlamp cleaning system*		6.4 US qt (6.0 l)	

¹ Use MB Windshield Washer Concentrate "S" and water for temperatures above freezing point or MB Windshield Washer Concentrate "S" and commercially available premixed windshield washer solvent/antifreeze for temperatures below freezing point. Follow suggested mixing ratios (▷ page 358).

Technical data

Fuels, coolants, lubricants, etc.

Engine oils

Engine oils are specifically tested for their suitability in our engines. Therefore, only use engine oils approved by Mercedes-Benz. Information on approved engine oils is available in the Factory Approved Service Products pamphlet, or at your authorized Mercedes-Benz Center.



Always check the oil filler cap (> page 255) for important information pertaining to the engine oil needing to meet a specific Mercedes-Benz specification (e.g. MB 229.5). If such information is printed on the oil filler cap, only use an engine oil from the list of approved engine oils in the Factory Approved Service Products pamphlet that meets the specification indicated on the oil filler cap.

Using engine oils of other specification may cause the FSS to incorrectly determine the next service interval and will result in engine damage not covered by the Mercedes-Benz Limited Warranty.

Please follow FSS recommendations for scheduled oil changes. Failure to do so could result in engine damage not covered by the Mercedes-Benz Limited Warranty.

Engine oil additives

Do not blend oil additives with engine oil. They may damage the engine.

Damage or malfunctions resulting from blending oil additives are not covered by the Mercedes-Benz Limited Warranty.

Air conditioning refrigerant

R-134a (HFC) refrigerant and special PAG lubricating oil is used in the air conditioning system.

Never use R-12 (CFC) or mineral-based lubricating oil. Otherwise damage to the system will occur.

Brake fluid

During vehicle operation, the boiling point of the brake fluid is continuously reduced through the absorption of moisture from the atmosphere. Under extremely strenuous operating conditions, this moisture content can lead to the formation of bubbles in the system, thus reducing the system's efficiency.

Therefore, the brake fluid must be replaced every two years, preferably in the spring.

Only brake fluid approved by Mercedes-Benz is recommended. Your authorized Mercedes-Benz Center will provide you with additional information.

Premium unleaded gasoline



To maintain the engine's durability and performance, premium unleaded gasoline must be used. If premium unleaded is not available and low octane fuel is used, follow these precautions:

- Have the fuel tank only partially filled with unleaded regular and fill up with premium unleaded as soon as possible.
- Avoid full throttle driving and abrupt acceleration.
- Do not exceed an engine speed of 3000 rpm if the vehicle is loaded with a light load such as two persons and no luggage.
- Do not exceed $\frac{2}{3}$ of maximum accelerator pedal position if the vehicle is fully loaded or operating in mountainous terrain.

Fuel requirements



Flexible Fuel Vehicles (identified by a label reading **Premium gasoline or E85 only!**) are designed to operate on premium unleaded gasoline or Ethanol fuel (E85) or any mixture of these two.

See notes on Flexible Fuel Vehicles (> page 354).

Only use premium unleaded meeting ASTM standard D 439:

- The octane number (posted at the pump) must be 91 min. It is an average of both the Research (R) octane number and the Motor (M) octane number: $(R+M)/2$. This is also known as the ANTI-KNOCK INDEX.

Unleaded gasoline containing oxygenates such as Ethanol, IPA, IBA and TBA can be used provided the ratio of any one of these oxygenates to gasoline does not exceed 10%; MTBE must not exceed 15%.

The ratio of Methanol to gasoline must not exceed 3% plus additional cosolvents.

Using mixtures of Ethanol and Methanol is not allowed. Gasohol, which contains 10% Ethanol and 90% unleaded gasoline, can be used.

These blends must also meet all other fuel requirements, such as resistance to spark knock, boiling range, vapor pressure, etc.

Technical data

Fuels, coolants, lubricants, etc.

Gasoline additives

A major concern among engine manufacturers is carbon build-up caused by gasoline. Mercedes-Benz recommends only the use of quality gasoline containing additives that prevent the build up of carbon deposits.

After an extended period of using fuels without such additives, carbon deposits can build up especially on the intake valves and in the combustion area, leading to engine performance problems such as:

- Warm-up hesitation
- Unstable idle
- Knocking/pinging
- Misfire
- Power loss

Do not blend any specific fuel additives with fuel. This only results in unnecessary cost and may be harmful to engine operation.

Damage or malfunctions resulting from poor fuel quality or from blending specific fuel additives are not covered by the Mercedes-Benz Limited Warranty.

Flexible Fuel Vehicles

Flexible Fuel Vehicles are identified by a label reading **Premium gasoline or E85 only!** on fuel filler flap.

These vehicles are designed to operate on premium unleaded gasoline or Ethanol fuel (E85), or on any mixture of these two.

Ethanol fuel (E85) is a mixture of approximately 85% Ethanol and 15% unleaded gasoline.

Warning!



Ethanol fuel (E85) and its fumes are highly flammable, poisonous and burn easily. Ethanol fuel can cause serious injuries if ignited or if you come into contact with it or inhale fumes of it. Avoid inhalation of Ethanol fumes and skin contact with Ethanol. Extinguish all open flames before fueling. Never smoke or create sparks close to Ethanol.

Switching fuels

For best performance and driveability it is recommended to use either one or the other fuel. A refueling pattern that alternates between the two different fuels should be avoided if possible.

When switching fuels, make sure:

- Fuel level is below half full.
- Fuel level is above reserve (fuel reserve warning lamp is not lit).
- Amount of added fuel is more than 5 gallons (20 liters).
- Ignition is off during refill.
- Immediately after refueling engine is started and operated for at least five minutes.

These precautions and recommendations are supposed to prevent any difficulties when starting and operating the engine which otherwise may be experienced before the engine has fully adapted to the different fuel.

If in spite of these recommendations the engine does not perform properly, adding more gasoline [at least 3 gallons (12 liters)] to the fuel may improve the engine behavior.

Cold weather performance

It is possible that starting times will significantly increase at temperatures below 32°F (0°C). At low temperatures the use of a block heater (Canada only) is recommended (see your authorized Mercedes-Benz Center for further information). Rough idling may also be experienced at such temperatures before the engine is fully warmed up.



E85 fuel is unsuitable for use when ambient temperatures fall below 14°F (-10°C).

Hot weather performance

At ambient temperatures above 95°F (35°C) start times may increase and be accompanied by a rough idle following the start.

Cruising range

E85 fuel contains less energy per gallon than gasoline. To ensure that engine performance with Ethanol fuel is similar to that when using gasoline, the engine must burn more Ethanol fuel. As a result, it is to be expected that the fuel consumption will increase when using E85 compared to gasoline operation.



Use of E85 may reduce your driving range.

Maintenance

Please inform your Mercedes-Benz Center if you use or have used E85 fuel when your vehicle is delivered for maintenance or repairs.

Technical data

Fuels, coolants, lubricants, etc.

Coolants

The engine coolant is a mixture of water and anticorrosion/antifreeze, which provides:

- Corrosion protection
- Freeze protection
- Boiling protection (by increasing the boiling point)

The cooling system was filled at the factory with a coolant providing freeze protection to approximately -22°F (-30°C) and corrosion protection.

If the antifreeze mixture is effective to -22°F (-30°C), the boiling point of the coolant in the pressurized cooling system is reached at approx. 266°F (130°C).

The coolant solution must be used year-round to provide the necessary corrosion protection and increase boil-over protection. Refer to Service Booklet for replacement interval.

Coolant system design and coolant used stipulate the replacement interval. The replacement interval published in the Service Booklet is only applicable if MB 325.0 anticorrosion/antifreeze solution or other Mercedes-Benz approved products of equal specification (see Factory Approved Service Products pamphlet) are used to renew the coolant concentration or bring it back up to the proper level.

To provide important corrosion protection, the solution must be at least 45% anticorrosion/antifreeze [equivalent to freeze protection to approx. -22°F (-30°C)].

If you use a solution that is more than 55% anticorrosion/antifreeze [freeze protection to approx. -49°F (-45°C)], the engine temperature will increase due to the lower heat transfer capability of the solution. Therefore, do not use more than this amount of anticorrosion/antifreeze.

If the coolant level is low, water and MB 325.0 anticorrosion/antifreeze should be used to bring it up to the proper level (have cooling system checked for signs of leakage). Please make sure the mixture is in accordance with label instructions.

The water in the cooling system must meet minimum requirements, which are usually satisfied by normal drinking water. If you are not sure about the water quality, consult your authorized Mercedes-Benz Center.

Technical data

Fuels, coolants, lubricants, etc.

Anticorrosion/antifreeze

Your vehicle contains a number of aluminum parts. The use of aluminum components in motor vehicle engines necessitates that anticorrosion/antifreeze coolant used in such engines be specifically formulated to protect the aluminum parts.

Failure to use such anticorrosion/antifreeze coolant will result in a significantly shortened service life.

Therefore, the following product is strongly recommended for use in your vehicle:

Mercedes-Benz 325.0

Anticorrosion/Antifreeze Agent.

Before the start of the winter season (or once a year in hot southern regions), you should have the anticorrosion/antifreeze concentration checked. The coolant is also regularly checked each time you bring your vehicle to your authorized Mercedes-Benz Center for service.

Anticorrosion/antifreeze quantity

Model	Approx. freeze protection	
	-35°F (-37°C)	-49°F (-45°C)
C 230 Kompressor Sport	3.0 US qt (2.8 l)	3.3 US qt (3.1 l)
C 240/C 320 (all models)	3.4 US qt (3.2 l)	3.8 US qt (3.6 l)
C 32 AMG	3.4 US qt (3.2 l)	3.8 US qt (3.6 l)

Technical data

Fuels, coolants, lubricants, etc.

Windshield washer and headlamp cleaning* system

Both the windshield and headlamp washer systems are supplied from the windshield washer fluid reservoir.

The washer fluid reservoir has a capacity of approx.:

- 3.2 US qt (3.0 l) in vehicles without headlamp cleaning system*
- 6.4 US qt (6.0 l) in vehicles with headlamp cleaning system*

- ▶ Refill the reservoir with MB Windshield Washer Concentrate “S” and water (or concentrate and commercially available premixed windshield washer solvent/antifreeze, depending on ambient temperatures).

Warning!



Washer solvent/antifreeze is highly flammable. Do not spill washer solvent/antifreeze on hot engine parts, because it may ignite and burn. You could be seriously burned.

Windshield and headlamp washer fluid mixing ratio

For temperatures above freezing, use MB Windshield Washer Concentrate “S” and water:

- 1 part “S” to 100 parts water
[40 ml “S” to 1 gallon (4.0 liters) water]

For temperatures below freezing, use MB Windshield Washer Concentrate “S” and commercially available premixed windshield washer solvent/antifreeze:

- 1 part “S” to 100 parts solvent
[40 ml “S” to 1 gallon (4.0 liters) solvent]

▼ Consumer information

The following text is published as required of all manufacturers of passenger cars under Title 49, Code of U.S. Federal Regulations, Part 575 pursuant to the “National Traffic and Motor Vehicle Safety Act of 1966”.

Uniform tire quality grading

Quality grades can be found, where applicable, on the tire sidewall between tread shoulder and maximum section width. For example:

Tread wear	Traction	Temperature
200	AA	A

All passenger car tires must conform to federal safety requirements in addition to these grades.

Tread Wear

The tread wear grade is a comparative rating based on the wear rate of the tire when tested under controlled conditions on a specified government test course. For example, a tire graded 150 would wear one and one-half ($1\frac{1}{2}$) times as well on the government course as a tire graded 100. The relative performance of tires depends upon the actual conditions of their use, however, and may depart significantly from the norm due to variations in driving habits, service practices and differences in road characteristics and climate.

Technical data

Consumer information

Traction

The traction grades, from highest to lowest are AA, A, B, and C. Those grades represent the tire’s ability to stop on wet pavement as measured under controlled conditions on specified government test surfaces of asphalt and concrete. A tire marked C may have poor traction performance.

Warning!



The traction grade assigned to this tire is based on straight ahead braking traction tests, and does not include acceleration, cornering, hydroplaning, or peak traction characteristics.

Technical data

Consumer information

Temperature

The temperature grades are A (the highest), B, and C, representing the tire's resistance to the generation of heat and its ability to dissipate heat when tested under controlled conditions on a specified indoor laboratory test wheel. Sustained high temperature can cause the material of the tire to degenerate and reduce tire life, and excessive temperature can lead to sudden tire failure. Grade C corresponds to a level of performance which all passenger car tires must meet under the Federal Motor Vehicle Safety Standard No. 109.

Grades B and A represent higher levels of performance on the laboratory test wheel than the minimum required by law.

Warning!



The temperature grade for this tire is established for a tire that is properly inflated and not overloaded. Excessive speed, underinflation, or excessive loading, either separately or in combination, can cause excessive heat build-up and possible tire failure.

ABS

(Antilock Brake System)

Prevents the wheels from locking up during braking so that the vehicle can continue to be steered.

Alignment bolt

Metal pin with thread. The centering pin is an aid used when changing a tire to align the wheel with the wheel hub.

BabySmart^{TM1} airbag deactivation system

This system detects if a special system compatible child restraint seat is installed on the front passenger seat. The system will automatically deactivate the passenger front airbag when such a seat is properly installed (PASS. AIRBAG OFF indicator lamp located in the center console comes on). See your authorized Mercedes-Benz Center for availability.

BabySmartTM compatible child seats

Special restraint system for children. The sensor system for the passenger seat prevents deployment of the passenger front airbag if a BabySmartTM compatible child seat is installed.

BAS

(Brake Assist System)

System for potentially reducing braking distances in emergency braking situations. The system is activated when it senses an emergency based on how fast the brake is applied.

Bi-Xenon headlamps*

Headlamps which use an electric arc as the light source and produce a more intense light than filament headlamps. Bi-Xenon headlamps produce low beam and high beam.

CAC

(Customer Assistance Center)

Mercedes-Benz customer service center, which can help you with any questions about your vehicle and provide assistance in the event of a breakdown.

CAN system

(Controller Area Network)

Data bus network serving to control vehicle functions such as door locking or windshield wiping depending on vehicle settings and/or ambient conditions.

Cockpit

All instruments, switches, buttons and indicator/warning lamps in the passenger compartment needed for vehicle operation and monitoring.

¹ BabySmartTM is a trademark of Siemens Automotive Corp.

Technical terms

COMAND*

(Cockpit Management and Data System)

Information and operating center for vehicle sound and communications systems, including the radio and the navigation system, as well as other optional equipment (CD changer*, telephone*, etc.).

Control system

The control system is used to call up vehicle information and to change component settings. Information and messages appear in the multifunction display. The driver uses the buttons on the multifunction steering wheel to navigate through the system and to adjust settings.

Cruise control

Driving convenience system for automatically maintaining the vehicle speed set by the driver.

Engine number

The number set by the manufacturer and placed on the cylinder block to uniquely identify each engine produced.

Engine oil viscosity

Measurement for the inner friction (viscosity) of the oil at different temperatures. The higher the temperature an oil can tolerate without becoming thin, or the lower the temperature it can tolerate without becoming viscous, the better the viscosity.

ESP

(Electronic Stability Program)
Improves vehicle handling and directional stability.

ETD

(Emergency Tensioning Device)
Device which deploys in certain frontal and rear collisions exceeding the system's threshold to tighten the seat belts.
->SRS

FSS

(Flexible Service System)

Service indicator in the multifunction display that informs the driver when the next vehicle maintenance service is due.

Gear range

Number of gears which are available to the automatic transmission for shifting. The automatic gear shifting process can be adapted to specific operating conditions using the gear selector lever.

GPS

(Global Positioning System)

Satellite-based system for relaying geographic location information to and from vehicles equipped with special receivers. Employs CD digital maps for navigation.

Instrument cluster

The displays and indicator/warning lamps in the driver's field of vision, including the tachometer, speedometer, engine temperature display and fuel gauge.

Kickdown

Depressing the accelerator past the point of resistance shifts the transmission down to the lowest possible gear. This very quickly accelerates the vehicle and should not be used for normal acceleration needs.

Lock button

Button on the door which indicates whether the door is locked or unlocked. Pushing the lock button down on an individual door from inside will lock that door.

Memory function*

Used to store three individual seat, steering wheel and mirror positions for each SmartKey.

Menu

The control system displays are arranged in menus. Each menu contains a number of commands for particular systems. In the Audio menu, for example, you will find the commands `SELECT RADIO STATION` or `OPERATE CD PLAYER`. Using commands, you can directly change the settings for your vehicle.

MON

(Motor Octane Number)
The Motor Octane Number for gasoline as determined by a standardized method. It is an indication of a gasoline's ability to resist undesired detonation (knocking). The average of both the MON (Motor Octane Number) and →RON (Research Octane Number) is posted at the pump, also known as ANTI-KNOCK INDEX.

Multifunction display

Display field in the instrument cluster used to present information provided by the control system.

Multifunction steering wheel

Steering wheel with buttons for operating the control system.

Overspeed range

Engine speeds within the red marking of the tachometer dial. Avoid this engine speed range, as it may result in serious engine damage that is not covered by the Mercedes-Benz Limited Warranty.

Poly-V-belt drive

Drives engine-components (alternator, AC compressor, etc.) from the engine.

Technical terms

Power train

Collective term designating all components used to generate and transmit motive power to the drive axles, including

- engine
- clutch/torque converter
- transmission
- transfer case
- drive shaft
- differential
- axle shafts/axles

Program mode selector switch

Used to switch the automatic transmission between standard operation **S** and comfort operation **C**.

Remote Vehicle Diagnostics

Transmission of vehicle data and current location to the Mercedes-Benz Customer Assistance Center for subscribers to Tele Aid service.

REST

(Residual engine heat utilization)
Feature that uses the engine heat stored in the coolant to heat the vehicle interior for a short time after the engine has been turned off.

Restraint systems

Seat belts, belt tensioners, airbags and child restraint systems. As independent systems, their protective functions complement one another.

RON

(Research Octane Number)
The Research Octane Number for gasoline as determined by a standardized method. It is an indication of a gasoline's ability to resist undesired detonation (knocking). The average of both the →MON (Motor Octane Number) and RON (Research Octane Number) is posted at the pump, also known as ANTI-KNOCK INDEX.

Shift lock

When the vehicle is parked, this lock prevents the transmission gear selector lever from being moved out of position **P** without SmartKey turned and brake pedal depressed.

SRS

(Supplemental Restraint System)
Seat belts, emergency tensioning device and airbags. Though independent systems, they are closely interfaced to provide effective occupant protection.

Tele Aid* System

(Telematic Alarm Identification on Demand)

The Tele Aid system consists of three types of response: automatic and manual emergency, roadside assistance and information. Tele Aid is initially activated by completing a subscriber agreement and placing an acquaintance call.

The Tele Aid system is operational provided that the vehicle's battery is charged, properly connected, not damaged and cellular and GPS coverage is available.

Telematics*

A combination of the terms "telecommunications" and "informatics".

Tightening torque

Force times lever arm (e.g. a lug wrench) with which threaded fasteners such as wheel bolts are tightened.

Tire speed rating

Part of tire designation; indicates the speed range for which a tire is approved.

Traction

Force exerted by the vehicle on the road via the tires.

VIN

(Vehicle Identification Number)

The number set by the manufacturer and placed on the body to uniquely identify each vehicle produced.

Voice control system*

Voice control system for car phones, portable cell phones and audio systems (radio, CD, etc.).



A

- ABS 23, 72, 361
 - ABS control 72
 - Malfunction indicator lamp 274
 - Messages in display 284
- Accelerator position,
 - automatic transmission* 147
- Accident
 - In case of 49
- Activating
 - Air conditioning (cooling)
 - Automatic climate control* 170
 - Climate control 160
 - Air recirculation mode
 - Automatic climate control* 167
 - Climate control 158
 - Anti-theft alarm system* 78
 - Automatic climate control* 163
 - Central locking (control system) 133
 - Charcoal filter 169
 - Climate control 155
 - Climate control system 159
 - Defrosting
 - Automatic climate control* 167
 - Climate control 158
 - Easy-entry/exit feature* 134
 - ESP 76
 - Exterior headlamps 46
 - Exterior lamps 103
 - Exterior rear view mirror
 - parking position* 150
 - Hazard warning flasher 106
 - Headlamps 46
 - High beams 106
 - Ignition 31
 - Immobilizer 52
 - Rapid seat heating* 98
 - Rear fog lamp 104, 105
 - Rear window defroster 153
 - Residual heat 171
 - Seat heating* 98
 - Tow-away alarm* 80
 - Windshield wipers 48
- Adding
 - Coolant 257
 - Engine oil 255
- Additional turn signals 310
- Adjustable air vents,
 - rear passenger compartment
 - Automatic climate control* 172
 - Climate control 161
- Adjusting 32
 - Air distribution
 - Automatic climate control* 166
 - Climate control 157
 - Air volume
 - Automatic climate control* 166
 - Climate control 157
 - Backrest contour 97
 - Backrest side bolsters 97
 - Backrest tilt
 - Manual seat 33
 - Power seat* 35
 - Exterior rear view mirrors 38

Index

- Head restraint height, front seats
 - Manual seat 34
 - Power seat* 35
- Head restraint height, rear seats 94
- Head restraint tilt, front seats
 - Manual seat 34
 - Power seat* 36
- Head restraint tilt, rear seats 96
- Head restraints, rear seats
 - Folding back 95
 - Folding back with release switch 95
 - Placing upright 95
- Instrument cluster illumination 109
- Interior rear view mirror 38
- Manual seat 33
- Mirrors 38
- Multicontour seat* 97
- Power seat* 35
- Rear seat head restraints 94
- Seat belt height 42
- Seat cushion depth 97
- Seat cushion tilt
 - Manual seat 33
 - Power seat* 35
- Seat fore and aft adjustment
 - Manual seat 33
 - Power seat* 35
- Seat height
 - Manual seat 33
 - Power seat* 35
- Seats 32
- Steering column height, electrical* 38
- Steering column height, manual 37
- Steering column length, electrical* 38
- Steering column length, manual 37
- Steering wheel 36
- Air conditioning (cooling)
 - Turning off
 - Automatic climate control* 170
 - Climate control 160
 - Turning on
 - Automatic climate control* 170
 - Climate control 160
- Air conditioning refrigerant 352
- Air distribution
 - Adjusting
 - Automatic climate control* 166
 - Climate control 157
- Air pressure see Tire inflation pressure
- Air recirculation mode
 - Activating
 - Automatic climate control* 167
 - Climate control 158
 - Deactivating
 - Automatic climate control* 168
 - Climate control 159

- Air vents, rear passenger compartment
 - Adjustable
 - Automatic climate control* 172
 - Climate control 161
- Air volume
 - Adjusting
 - Automatic climate control* 166
 - Climate control 157
- Airbags 55
 - BabySmart™ deactivation system 66, 361
 - Children 56
 - Front 59
 - Passenger 59
 - Safety guidelines 58
 - Side impact 60
 - Window curtain 60
- Alarm
 - Audible 71, 78
 - Canceling 79
 - Visual 78
- Alarm system
 - Anti-theft* 78
 - Tow-away* 79
- Alignment bolt (vehicle tool kit) 319, 361
- Anticorrosion/antifreeze 357
- Antiglare
 - Automatic* 149
 - Manual 149
- Antilock Brake System see ABS
- Anti-theft alarm system*
 - Arming 78
 - Canceling alarm 79
 - Disarming 79
- Anti-theft systems 78
 - Anti-theft alarm system* 78
 - Immobilizer 78
 - Tow-away alarm* 79
- Aquaplaning see Hydroplaning
- Armrest
 - Storage compartment in front of 218
 - Storage spaces 219
- Ashtrays 220
- ATF 256
- AUDIO menu 118
 - Selecting radio station 119
 - Selecting satellite radio* station 119
- Audio system 173
 - Audio and telephone, operation 173
 - Button and soft key operation 176
 - Cassette operation 186
 - CD* operation 189
 - Operating and display elements 174
 - Operating safety 173
 - Operation 176
 - Radio operation 179
 - Switching off 176
 - Switching on 176
 - Telephone* operation 193
- Automatic antiglare* for rear view mirror 149
- Automatic central locking
 - Activating/deactivating (control system) 133

Index

- Automatic climate control* 162
 - Activating 163
 - Adjusting air distribution 166
 - Adjusting air volume 166
 - Air recirculation mode 167
 - Deactivating 163
 - Defrosting 167
 - Rear window defroster 153
 - Residual heat utilization 171
 - Residual ventilation 171
 - Setting the temperature 165
- Automatic headlamp mode 103
- Automatic lighting control
 - Activating 107
 - Deactivating 107
- Automatic locking when driving 90
- Automatic transmission fluid see ATF
- Automatic transmission* 142
 - Accelerator position 147
 - Comfort program mode 146
 - Emergency operation (Limp Home Mode) 147
 - Fluid level 256
 - Gear ranges 144
 - Gear selector lever 44
 - Gear selector lever position 142, 145
 - Gear shifting malfunctions 147
 - Kickdown 147
 - Manual shifting 143
 - One-touch gearshifting 143
 - Program mode selector switch 146
 - Starting with 44
 - Transmission fluid 256
- Auxiliary fuse box 334
- B**
- BabySmart™
 - Airbag deactivation system 66, 361
 - Compatible child seats 66, 361
 - Self-test 66
- Backrest
 - Folding forward 213
 - Folding rearward 213
- Backrest contour
 - Adjusting 97
- Backrest side bolsters
 - Adjusting 97
- Backrest tilt
 - Manual seat 33
 - Power seat* 35
- Backup lamps 311, 315
 - Bulbs 310
- BAS 73, 361
 - Messages in display 281
- Batteries, SmartKey
 - Changing 307
 - Check lamp 83
 - Checking 84
- Battery discharged
 - Jump starting 326
- Battery, vehicle 258, 323
 - Charging 324
 - Disconnecting 324
 - Messages in display 285
 - Reconnecting 325
 - Reinstalling 324
 - Removing 324

- Bi-Xenon headlamps* 361
- Bi-Xenon type*
 - Front lamp bulbs 313
- Block heater 264
- Blocking
 - Rear door window operation 70
- Bolts
 - For Minispare wheel 304
- Brake Assist System see BAS
- Brake fluid 352
 - Checking 251
 - Message in display 286
- Brake lamp bulbs 311
- Brake lamp, high mounted 311
- Brake pads
 - Message in display 286
- Brakes 240
 - Warning lamp 275
- Break-in period 238
- Bulbs, replacing 310
 - Additional turn signals 310
 - Backup lamps 311
 - Brake lamps 311
 - Fog lamps 310
 - Front lamps 310
 - High beam 310
 - High beam flasher 310
 - High mounted brake lamp 311
 - License plate lamps 311, 315
 - Low beam 310
 - Parking lamps 310, 311, 313, 314
 - Rear fog lamp 311, 315
 - Rear lamps 311
 - Side marker lamps 310, 314
 - Standing lamps 310, 311, 313, 314
 - Tail lamp assemblies 311, 315
 - Turn signal lamps 310, 311
- Button
 - Audio system 176
- C**
- CAC 361
- California
 - Important notice 11
- Calling up
 - Range (distance to empty) 138
 - Service indicator 266
- CAN system 361
- Capacities
 - Fuels, coolants, lubricants, etc. 349
- Cargo area see Trunk
- Cassette operation
 - Playing cassettes 186
- Cassette player
 - Operating 121
- Catalytic converter 247
- CD changer* 189
- CD player*
 - Operating 120
- CD* operation 189

Index

- Center console 25
 - Lower part 26
 - PASS. AIRBAG OFF indicator lamp 279
 - Upper part 25
- Centigrade
 - Setting temperature units 127
- Central locking
 - Automatic 90
 - From inside 91
 - Switch 91
 - Switching on/off (control system) 133
 - Unlocking from inside 91
- Central locking switch 91
- Certification label 338
- Changing
 - Batteries (SmartKey) 307
 - CDs 189
 - Key setting 133
- Charcoal filter 169
- Charging
 - Vehicle battery 324
- CHECK ENGINE
 - malfunction indicator lamp 276
- Checking
 - Brake fluid 251
 - Coolant level 251, 257
 - Engine oil level 251, 254
 - Tire inflation pressure 251
 - Vehicle lighting 251
- Child safety 63
 - Airbags 56
 - Infant and child restraint systems 60, 63
 - LATCH-type child seat anchors 69
- Child safety switch see Blocking of rear door window operation
- Child seat anchors
 - see LATCH-type child seat anchors
- Cigarette lighter 221
- Cleaning
 - Cloth upholstery 272
 - Cup holder 271
 - Gear selector lever 271
 - Hard plastic trim items 271
 - Headlamps 148
 - Headliner and shelf below rear window 271
 - Instrument cluster 270
 - Leather upholstery 271
 - Light alloy wheels 270
 - MB Tex upholstery 272
 - Plastic and rubber parts 272
 - Seat belts 271
 - Steering wheel 271
 - Upholstery 271
 - Windows 270
 - Windshield 48
 - Wiper blades 270
 - Wood trims 272

- Climate control 154
 - Adjusting air distribution and volume 157
 - Defogging windshield 157
 - Defrosting 158
 - Setting the temperature 156
- Clock 23, 126
- Closing
 - Glove box 216
 - Hood 253
 - Sliding/pop-up roof* 204
 - Sliding/pop-up roof* in an emergency 309
 - Sliding/pop-up roof* with SmartKey 204
 - Trunk lid 87
 - Windows 201
 - Windows with SmartKey 202
- Cloth upholstery
 - Cleaning 272
- Cockpit 20, 361
- Cockpit Management and Data System
 - see COMAND*
- COMAND* 362
- COMAND*
 - see separate operating instructions
- Combination switch 105
 - High beam flasher 47
 - Turn signals 47
 - Windshield wipers 47
- Comfort driving
 - Transmission program mode 146
- Consumer information 359
- Control and operation of radio transmitters 246
- Control system 113, 362
 - AUDIO menu 118
 - Convenience submenu 133
 - Display digital speedometer 118
 - Functions 114, 117
 - Instrument cluster submenu 126
 - Lighting submenu 129
 - Malfunction memory menu 122
 - Menus 116, 117, 363
 - Multifunction display 113
 - Multifunction steering wheel 114
 - NAVI* menu 121
 - Selecting radio system 119
 - Selecting satellite radio* system 119
 - Settings menu 123
 - Standard display menu 118
 - Submenus 115, 117
 - TEL* menu 138
 - Trip computer menu 136
 - Vehicle submenu 132
- Controller Area Network see CAN system
- Convenience submenu 133
 - Activating easy-entry/exit feature* 134
 - Setting key dependency 135
 - Setting parking position* for exterior rear view mirror 136

Index

- Coolant 257, 356
 - Adding 257
 - Anticorrosion/antifreeze
 - quantity 356
 - Capacities 350
 - Checking level 257
 - Messages in display 287–289
 - Temperature 248
 - Temperature display 110
 - Coolant level
 - Checking 257
 - Cruise control 206, 362
 - Canceling 207
 - Driving downhill 207
 - Driving uphill 207
 - Fine adjustment 208
 - Message in display 290
 - Setting current speed 207
 - Setting speeds 208
 - Cruise control lever 206
 - Cruising range, fuel 355
 - Cup holder
 - Cleaning 271
 - In front of seat armrest 217
 - In rear seat armrest 218
 - Customer Assistance Center see CAC
 - D**
 - Daytime running lamp mode 104
 - Setting 129
 - Deactivating
 - Air conditioning (cooling)
 - Automatic climate control* 170
 - Climate control 160
 - Air recirculation mode
 - Automatic climate control* 168
 - Climate control 159
 - Alarm 79
 - Anti-theft alarm system* 79
 - Automatic climate control* 163
 - Central locking (control system) 133
 - Climate control 155
 - Climate control system 159
 - Cruise control 207
 - Defrosting
 - Automatic climate control* 167
 - Climate control 158
 - Engine with the SmartKey 52
 - ESP 75
 - Exterior lamps 103
 - Exterior lamps delayed shut-off 131
 - Front fog lamps 131
 - Hazard warning flasher 106
 - Headlamps 51
 - Interior lighting delayed shut-off 132
 - Rapid seat heating* 98
 - Rear window defroster 153
 - Seat heating* 98
 - Tow-away alarm* 80
- Deep water see Standing water
 - Defogging
 - Windshield
 - Automatic climate control* 166
 - Climate control 157

- Defrosting
 - Automatic climate control* 167
 - Climate control 158
- Delayed shut-off
 - Exterior lamps 131
 - Interior lighting 132
- Dialing
 - A number (telephone*) 140
- Difficulties
 - While driving
 - see Problems while driving
 - With starting 44
- Digital speedometer 118
- Direction of rotation (tires) 261
- Discharged battery
 - Jump starting 326
- Disconnecting
 - Vehicle battery 324
- Display
 - Messages in display 290
- Display elements
 - Audio system 174
- Displays
 - Digital speedometer 118
 - Messages 280
 - Selecting 129
 - Service indicator 265
 - Showing malfunctions 122
 - Symbol messages 284
 - Text messages 281
- Distance to empty (range)
 - Calling up 138
- Door control panel 28
- Door entry lamps 108
- Door handle 28
- Door unlock
 - With Tele Aid* 230
- Doors
 - Message in display 290
 - Opening from inside vehicle 85
 - Opening from the outside 83
- Downhill driving
 - Cruise control 207
- Downshifting
 - Automatic transmission* 143
 - Manual transmission 141
- Drink holder see Cup holder
- Drinking and driving 239
- Driving
 - Driving abroad 246
 - General instructions 40, 239
 - Hydroplaning 242
 - In winter 244
 - Problems 49
 - Safety systems 72
 - Through standing water 245
- Driving abroad 246
- Driving instructions 239
- Driving off 241
- Driving safety systems
 - 4MATIC 77
 - ABS 72
 - BAS 73
 - ESP 74
- Driving systems 206
 - Cruise control 206
 - Driving safety systems 72

Index

E

- Easy-entry/exit feature* 92
 - Activating 134
 - Interrupting movement 92, 134
- Electrical fuses 332
- Electrical system
 - Technical data 346
- Electronic Stability Program see ESP
- Emergency call system* 223
- Emergency calls
 - Initiating an emergency call 226
 - Telephone* 198
 - With Tele Aid* 224
- Emergency operation (Limp Home Mode) 147
- Emergency operations
 - Closing sliding/pop-up roof* 309
 - Locking the vehicle 306
 - Opening sliding/pop-up roof* 309
 - Releasing trunk lid from inside 88
 - Remote door unlock 230
 - Unlocking the vehicle 305
- Emergency Tensioning Device see ETD
- Emission control 247
- Emission control label 338
- Ending
 - A call (telephone*) 139
- Engine
 - Compartment 252
 - Starting with
 - automatic transmission* 44
 - manual transmission 43
 - Starting with the SmartKey
 - Automatic transmission* 44
 - Manual transmission 43
 - Technical data 340
 - Turning off with the SmartKey 52
- Engine cleaning 269
- Engine compartment 252
 - Fuse box in 333
 - Hood 252
- Engine malfunction indicator lamp 23, 276
- Engine number 338, 362
- Engine oil 253, 352
 - Adding 255
 - Additives 352
 - Checking level 251, 254
 - Consumption 253
 - Display messages 254, 291–292
 - Filler neck
 - C 230 Kompressor Sport 256
 - C 240, C 320, and C 32 AMG 256
 - Messages in display 254, 291–292
 - Viscosity 362
- Engine oil level
 - Checking 251, 254
- ESP 23, 74, 362
 - Four wheel electronic traction system with ESP 77
 - Messages in display 282–283
 - Switching off 75
 - Switching on 76
 - Synchronizing 282
 - Warning lamp 277

- ETD 63, 362
 - Safety guidelines 58
- Ethanol fuel
 - At the gas station 249
 - Requirements 354
 - Switching fuels 354
- Exterior lamp switch 46, 102
- Exterior lamps
 - Delayed shut-off 131
- Exterior rear view mirrors
 - Adjusting 38
 - Parking position* for 136
- F**
- Fahrenheit
 - Setting temperature units 127
- Fastening the seat belts 40
- Filler neck
 - C 230 Kompressor Sport 256
 - C 240, C 320, and C 32 AMG 256
- Fine adjustment
 - Cruise control 208
- First aid kit 300
- Flat tire 317
 - Lowering the vehicle 321
 - Minispare wheel 302
 - Mounting the Minispare wheel 317
 - Preparing the vehicle 317
- Flexible fuel vehicles 354
 - At the gas station 249
 - Switching fuels 354
- Flexible Service System see FSS
- Fog lamp, rear
 - Message in display 294
 - Replacing bulb 311
 - Switching on 105
- Fog lamps, front
 - Messages in display 294
 - Replacing bulbs 310
 - Switching on 105
- Four wheel electronic traction system (4MATIC) with ESP 77
- 4MATIC 77
- Front airbags 59
- Front lamps
 - Bi-Xenon* type 313
 - Halogen-type 312
 - Messages in display 293–296
 - Replacing bulbs 310, 312
 - Switching on 102
- Front seat head restraints
 - Installing
 - Manual seat 93
 - Power seat* 94
 - Manual seat 93
 - Power seat* 94
 - Removing
 - Manual seat 93
 - Power seat* 94
- Front seats
 - Heating* 98

Index

- FSS 265, 362
 - Fuel 250
 - Additives 354
 - Cruising range 355
 - E85 (Ethanol fuel) 355
 - Fuel reserve warning lamp 278
 - Gasoline additives 354
 - Message in display 293
 - Premium unleaded
 - gasoline 250, 350, 353
 - Requirements 353, 354
 - Reserve warning 23
 - Switching (Flexible Fuel Vehicle) 354
 - Technical data 350
 - Fuel additives 354
 - Fuel cap
 - Message in display 293
 - Fuel consumption statistics
 - After start 137
 - Since last reset 137
 - Fuel filler flap 249
 - Locking 249
 - Opening in an emergency 308
 - Unlocking 249
 - Fuel requirements 353
 - For ethanol fuel 354
 - Fuel reserve tank
 - Message in display 293
 - Fuel tank
 - Capacity 350
 - Filler flap 249
 - Fuels, coolants, lubricants etc.
 - Capacities 349
 - Functions (control system) 114, 117
 - Resetting 124
 - Fuse box
 - Auxiliary in trunk 334
 - In engine compartment 333
 - In passenger compartment 332
 - Fuse chart 332
 - Fuse extractor 334
 - Fuses 332
 - Auxiliary fuse box in trunk 334
 - Fuse box in engine compartment 333
 - Fuse box in
 - passenger compartment 332
 - Fuse chart 332
 - Fuse extractor 334
 - Spare fuses 334
- G**
- Garage door opener 27, 231
 - Gasoline additives 354
 - Gasoline see Fuel
 - Gear range 362
 - Automatic transmission* 144
 - Limiting 144
 - Shifting into optimal 143
 - Gear range limit
 - Canceling 143

Gear selector lever 23, 44
 Cleaning 271
 Lock 44
 Position (Automatic transmission*) 23, 142, 145
 Gearshift lever 43
 Global
 Locking 83
 Unlocking 83
 Global Positioning System see GPS
 Glove box 21, 216
 Closing 216
 Opening 216
 Good visibility 148
 GPS 362
 GPS see COMAND*

H

Halogen-type
 Front lamp bulbs 312
 Hands-free microphone 27
 Hard plastic trim items
 Cleaning 271

Hazard warning flasher 106
 Switching off 106
 Switching on 106
 Head restraints
 Front seats
 Manual seat 34, 93
 Power seat* 35, 94
 Rear seats 94
 Headlamp cleaning system* 259
 Headlamp shut-off delay see Delayed shut-off, exterior lamps
 Headlamps
 Automatic control 103
 Bi-Xenon* 361
 Bi-Xenon* type
 Replacing bulbs 313
 Cleaning 269
 Cleaning system* 148, 259, 358
 Halogen-type
 Replacing bulbs 312
 Refilling washer fluid 259
 Switching off 51
 Switching on 46
 Washer fluid 358

Headliner and shelf below rear window
 Cleaning 271
 Heated seats* 98
 Height adjustment
 Front seat head restraints
 Manual seat 34
 Power seat* 35
 Rear seat head restraints 94
 Seat belts 42
 Steering wheel
 Adjustment, electrical* 37
 Adjustment, manual 37
 High beam flasher 47, 106
 High beam headlamps
 Messages in display 294
 Replacing bulbs 310, 312
 Switching on 106
 High beam headlamps xenon type*
 Replacing bulbs 313
 High mounted brake lamp 311

Index

Hood 252
Closing 253
Message in display 293
Opening 252
Hydroplaning 242

I

Identification labels 338
Certification label 338
Vehicle Identification Number 338
Ignition 31
Switching on
Automatic transmission* 44
Manual transmission 43
Immobilizer 78
Activating 78
Deactivating 78
Indicator lamps
see Lamps, indicator and warning

Infant and child restraint systems 63
Installing 68
LATCH-type child seat anchors 69

Information

About service and warranty 10
Button for Tele Aid* 227

Installing

Infant and child restraint systems 68
Ski sack* 212
Towing eye bolt 331
Wiper blades 316

Instrument cluster 22, 109, 363

Cleaning 270
Coolant temperature display 110
Illumination 109
Lamps in 274-278
Multifunction display 113
Outside temperature indicator 111
Selecting language 128

Instrument lighting 109

Instruments and controls see Cockpit

Interior lighting 107
Activating automatic control 107
Deactivating automatic control 107
Delayed shut-off 132
Manual operation 107

Interior rear view mirror

Adjusting 38
Antiglare 149

Interior storage spaces 216

Armrest 219
Cup holder in front
of seat armrest 217
Cup holder in rear seat armrest 218
Glove box 216
Parcel net in
front passenger footwell 220
Storage compartment
in front of armrest 218

J

Jack 300
Jump starting 326

K

- Key dependency memory
 - Settings 135
- Key positions in starter switch 31
- Key, mechanical 305
- Key, SmartKey
 - Battery check lamp 83
 - Checking the batteries 84
 - Factory setting 83
 - Global locking 83
 - Global unlocking 83
 - Loss of 85
 - Messages in display 293
 - Positions in starter switch 31
 - Remote control 82
 - Restoring to factory setting 83
 - Selective setting 83
 - Starting the engine
 - Automatic transmission* 44
 - Manual transmission 43
 - Turning off the engine 52

- Unlocking the trunk lid 84
- Unlocking with 30
- Kickdown 147, 363
- Kilometers/miles in speedometer 128
- Km/h or mph in speedometer 128

L

- Labels, identification 338
- Lamp bulbs, exterior 310
- Lamps, exterior
 - Front 310
 - Light sensor 294
 - Messages in display 293–296
 - Rear 311
- Lamps, indicator and warning
 - ABS 274
 - Battery (SmartKey) 83
 - Brakes 275
 - CHECK ENGINE 276
 - Engine diagnostics 276, 278
 - ESP 277
 - Fuel reserve 278

- Instrument cluster 274–278
- PASS. AIRBAG OFF 59, 279
- Seat belts 278
- SRS 55, 278
- Turn signals 23

Language

- Multifunction display 128
 - Setting 128
- LATCH-type child seat anchors 69
 - Folding back 69
- Layout of poly-V-belt drive 339
- Leather upholstery
 - Cleaning 271
- License plate lamps
 - Messages in display 294
 - Replacing bulbs 311, 315
- Light alloy wheels
 - Cleaning 270
 - Technical data 343
- Light sensor 294
- Lighter see Cigarette lighter

Index

- Lighting 102
 - Automatic headlamp mode 103
 - Combination switch 105
 - Daytime running lamp mode 104
 - Door entry lamps 108
 - Exterior lamp switch 102
 - Front fog lamps 105
 - High beams 106
 - Instrument cluster illumination 109
 - Instruments 109
 - Interior 107
 - Locator lighting 104
 - Low beam 102
 - Manual headlamp mode 103
 - Night security illumination 104
 - Parking lamps 102
 - Rear fog lamp 105
 - Settings (control system) 129
 - Trunk lamp 108
 - Limiting the gear range 144
 - Limp Home Mode 147
 - Loading 209
 - Instructions 214
 - Roof rack* 209
 - Ski sack* 209
 - Split rear bench seat* 212
 - Locator lighting 104
 - Setting 130
 - Lock button 363
 - Locking 50, 82
 - Automatic while driving 90
 - Centrally from inside 91
 - Fuel filler flap 249
 - Global, SmartKey 83
 - Separately the trunk 89
 - Vehicle in an emergency 306
 - Loss of keys 85
 - Loss of Service and
 - Warranty Information Booklet 337
 - Low beam headlamps
 - Messages in display 295
 - Replacing bulbs 310, 312
 - Lowering
 - Vehicle 321
 - Lubricants
 - Technical data 349
- M**
- Main dimensions 347
 - Maintenance 12, 265
 - Vehicles with E85 fuel 355
 - Malfunction
 - Displaying 122
 - Malfunction memory 122
 - Calling up 122
 - Clearing 122
 - Manual headlamp mode 103
 - Manual operations
 - Fuel filler flap 308
 - Interior lighting control 107
 - Locking the trunk 89
 - Locking the vehicle 306
 - Sliding/pop-up roof* 309
 - Unlocking the driver's door 305
 - Unlocking the trunk 90, 306
 - Unlocking transmission
 - gear selector lever 308

- Manual seat
 - Adjusting 33
 - Adjusting backrest tilt 33
 - Adjusting head restraint height 34
 - Adjusting head restraint tilt 34
 - Adjusting seat cushion tilt 33
 - Adjusting seat height 33
 - Front seat head restraints 93
 - Seat fore and aft adjustment 33
- Manual transmission 141
 - Gearshift lever 43
 - Shifting into reverse 141
 - Starting with 43
- MAXCOOL Maximum cooling 167
- MB Tex upholstery
 - Cleaning 272
- Mechanical key 305
- Memory function* 99, 363
 - Recalling positions from memory 100
 - Storing exterior rear view mirror parking position 101
 - Storing key dependent settings 100
- Menus 114
 - AUDIO 118
 - Control system 363
 - In control system 116, 117
 - Malfunction memory 122
 - NAVI* 121
 - Settings menu 123
 - Standard display 118
 - Submenus 115
 - TEL* 138
 - Trip computer 136
- Microphone
 - Hands-free microphone 27
- Miles/kilometers in speedometer
 - Setting 128
- Minispare wheel 302
 - Bolts 304
 - Mounting 317
 - Removing 302
- Mirrors
 - Activating exterior rear view mirror parking position* 150
 - Adjusting 38
 - Automatic antiglare* for interior mirror 149
 - Automatic antiglare* for rear view mirror 149
 - Exterior rear view mirror 38
 - Exterior rear view mirror parking position* 136
 - Interior rear view mirror 38
 - Storing exterior rear view mirror parking position* 101
- MON 250, 363
- Motor Octane Number see MON
- Mph or km/h in speedometer 128
- Multicontour seat* 97
- Multifunction display 113, 363
 - Displaying gear range 144
 - Selecting language 128
 - Standard display 117

Index

Multifunction display messages

- ABS 284
- BAS 281
- Battery, vehicle 285
- Brake fluid 286
- Brake pads 286
- Coolant 287–289
- Cruise control 290
- Display 290
- Doors 290
- Engine oil 291–292
- ESP 282–283
- Fuel cap 293
- Fuel reserve tank 293
- Hood 293
- Key, SmartKey 293
- Lamps, exterior 293–296
- Oil 291–292
- Parking brake 286
- Restraint system 297

- Seat belts 297
- Sliding/pop-up roof* 299
- SRS 297
- Steering column not properly locked 298
- Steering gear oil level 298
- Tele Aid* 299
- Telephone* 299
- Trunk lid 299
- Windshield washer fluid 299

Multifunction steering wheel 24, 114, 363

- Buttons 114

N

- Navigation system*
 - Operating 121
 - See separate COMAND* operating instructions
- Night security illumination 104
 - Setting 131

O

- Occupant safety 54
 - Airbags 55
 - Children and airbags 56
 - Children in the vehicle 63
 - Fastening the seat belt 40
 - Infant and child restraint systems 63
 - LATCH-type child seat anchors 69
 - Seat belts 40, 58
- Odometer, main 23
- Oil level see Engine oil level
- Oil see Engine oil
- One-touch gearshifting 143
 - Canceling gear range limit 143
 - Downshifting 143
 - Upshifting 143
- Opening
 - Ashtray, center console 220
 - Ashtray, rear seat 221
 - Cup holder, in front of seat armrest 217

- Cup holder, in rear seat armrest 218
- Doors from the inside 85
- Fuel filler flap 250
- Fuel filler flap manually 308
- Glove box 216
- Hood 252
- Side windows 200
- Sliding/pop-up roof* 203, 309
- Sliding/pop-up roof*
 - in an emergency 309
- Sliding/pop-up roof*
 - with SmartKey 204
- Trunk 84
- Trunk from the inside 87
- Windows 200
- Windows with SmartKey 202
- Operating
 - Audio system 173
 - Cassette player 121
 - CD player* 120
 - COMAND*
 - see separate operating instructions
 - Navigation system* 121
 - Radio 119
 - Radio transmitters 246
 - Satellite radio* 119
 - Telephone* 138, 173, 193
 - Vehicle outside
 - the USA and Canada 13
- Operating safety
 - Audio system 173
- Operator's Manual 10
- Ornamental moldings 269
- Outer seats
 - Rear seat head restraints 94, 96
- Outside temperature indicator 111
- Overdue service 265
- Overhead control panel 27
- Overspeed range 363
- P**
 - Paintwork 268
 - Panic alarm* 71
 - Panic button on SmartKey 71
 - Parcel net
 - In front passenger footwell 220
 - Parking 50, 241
 - Parking brake 45, 50
 - Engaging 50
 - Message in display 286
 - Releasing 45
 - Parking lamps
 - Replacing bulbs 310, 311, 313, 314
 - Switching on 102
 - Parking position*
 - Exterior rear view
 - mirrors 101, 136, 150
 - Parts see Spare parts service
 - PASS. AIRBAG OFF indicator lamp 279
 - Passenger compartment 246
 - Fuse box in 332
 - Interior lighting 107
 - Interior rear view mirror 38
 - Parcel net in front
 - passenger footwell 220
 - Passenger safety see Occupant safety

Index

- Pedals 239
 - Performance
 - In cold weather 355
 - In hot weather 355
 - Phone book*
 - Loading 140
 - Quick search 140
 - Phone number*
 - Dialing 140
 - Redialing 140
 - Plastic and rubber parts
 - Cleaning 272
 - Playing
 - CDs 191
 - Poly-V-belt drive 363
 - Layout 339
 - Positions (Memory function*)
 - Recalling from memory 100
 - Storing into memory 100
 - Power assistance 239
 - Power seat*
 - Adjusting backrest tilt 35
 - Adjusting head restraint height 35
 - Adjusting head restraint tilt 36
 - Adjusting seat cushion tilt 35
 - Adjusting seat height 35
 - Memory function* 99
 - Removing/installing front head restraints 94
 - Seat fore and aft adjustment 35
 - Power train 364
 - Power washer 268
 - Power windows 200
 - Blocking of rear door window operation 70
 - Side windows 200
 - Synchronizing 202
 - Practical hints
 - First aid kit 300
 - Fuses 332
 - Lamp in center console 279
 - Lamps in instrument cluster 274
 - Messages in the display 280
 - Minispare wheel 302
 - Minispare wheel bolts 304
 - Symbol messages 284
 - Text messages 281
 - Towing the vehicle 328
 - Vehicle jack 301
 - Vehicle tool kit 300
 - Premium unleaded gasoline 353
 - Problems
 - While driving 49
 - With vehicle 17
 - Product information 9
 - Program mode selector switch 364
 - Automatic transmission* 146
- Q**
- Quick search
 - Phone book* 140

R

- Radio
 - Selecting stations 119
 - Station search 119
 - Station selection setting 132
- Radio operation 179
- Radio see Radio operation
- Radio transmitters,
 - control and operation 246
- Range (distance to empty)
 - Calling up 138
- Rapid seat heating*
 - Switching off 98
 - Switching on 98
- Reading lamp 27
- Rear bench seat
 - Foldable* 212
- Rear door window
 - Blocking operation 70
- Rear fog lamp 311
 - Bulb 311
 - Switching on 105
- Rear lamp bulbs
 - Replacing 315
- Rear lamps
 - Messages in display 293–296
- Rear lamps see Tail lamps
- Rear outer seats
 - Adjusting head restraint height 94
- Rear passenger compartment,
 - adjustable air vents
 - Automatic climate control* 172
 - Climate control 161
- Rear seat head restraints 94
 - Adjusting 94
 - Adjusting tilt 96
 - Folding back 95
 - Folding back with
 - switch in center console 95
 - Installing 97
 - Outer seats 96
 - Placing upright 95
 - Removing 96
- Rear view mirrors see Mirrors
- Rear window defroster 153
- Rear window sunshade* 152
- Reconnecting
 - Vehicle battery 325
- Refrigerant
 - Air conditioning 352
- Refueling 249
- Regular checks 251
- Reinstalling vehicle battery 324
- Remote control
 - SmartKey 82
- Remote door unlock
 - With Tele Aid* 230
- Remote Vehicle Diagnostics 364
- Removing
 - Minispare wheel 302
 - Ski sack* 212
 - Vehicle battery 324
 - Vehicle tool kit 300
 - Wheel 319
 - Wiper blades 316

Index

Replacing

- Backup lamp bulbs 315
- Brake lamp bulbs 315
- Bulbs 310
- Front lamp bulbs 310, 312
- Front turn signal bulbs 312, 314
- Fuses 334
- High beam bulbs 312
- High beam bulbs (xenon-type* headlamps) 313
- License plate lamp bulbs 315
- Low beam bulbs 312
- Parking lamp bulbs 313, 314
- Rear fog lamp bulb 315
- Rear lamp bulbs 311, 315
- Rear turn signal bulbs 315
- Side marker lamp bulbs 314
- Standing lamp bulbs 313, 314
- Wiper blades 316

Reporting

- Safety defects 18

Research Octane Number see RON

Reset button in the instrument cluster 23, 123, 124

Resetting

- All functions (control system) 123
- All functions of a submenu 124
- Fuel consumption 137
- Service indicator (FSS) 266
- Trip odometer 111

Residual heat utilization 171

Residual ventilation 171

REST 171, 364

Restraint system

Message in display 297

Restraint system see

Infant and child restraint systems

Reverse (manual transmission)

Shifting into 141

Rims 342

Roadside Assistance 12

RON 250, 364

Roof rack* 209

Rotating wheels 262

Rubber parts

Cleaning 272

S

Safety

Occupant 54

Safety belts see Seat belts

Safety defects

Reporting 18

Safety systems

Driving 72

Searching

Radio station 119

Seat belt force limiter 63

Seat belt height adjustment 42

Seat belts 60

Cleaning 271

Fastening 40

Height adjustment 42

Messages in display 297

Proper use of 42, 62

Safety guidelines 58

Warning lamp 278

- Seat cushion depth
 - Adjusting 97
- Seat heating*
 - Switching off 98
 - Switching on 98
- Seats 92
 - Adjusting 32
 - Easy entry/exit feature* 92
 - Heating* 98
 - Manual seat 33
 - Multicontour seat* 97
 - Power seat* 35
 - Split rear bench seat* 212
- Selecting
 - Display 129
- Selector lever see gear selector lever
- Self-test
 - BabySmart™
 - airbag deactivation system 66
 - Tele Aid* 224
- Service
 - Calling up the service indicator 266
 - Major service (Service B) 265
 - Minor service (Service A) 265
 - Overdue 265
 - Spare parts 336
 - Types 265
 - When due 265
- Service and Warranty Booklet
 - Loss of 337
- Service and warranty information 10
- Service indicator 265
 - Calling up 266
 - Clearing 265, 266
- Service life (tires) 261
- Service see Maintenance
- Service System see FSS
- Setting
 - Convenience functions 125, 133
 - Cruise control 207
 - Daytime running lamp mode 129
 - Higher speed in cruise control 208
 - Hours (clock) 126
 - Individual vehicle settings 123
 - Instrument lighting 109
 - Interior lighting delayed shut-off 132
 - Key dependent memory 135
 - Lamps and lighting
 - (control system) 129
 - Language, multifunction display 128
 - Locator lighting 130
 - Lower speed in cruise control 208
 - Miles/kilometers in
 - speedometer 128
 - Minutes (clock) 126
 - Night security illumination 131
 - Parking position* for exterior
 - rear view mirrors 136
 - Speed in cruise control 208

Index

- Speedometer display mode 128
- Station selection mode 132
- Temperature (Interior)
 - Automatic climate control* 165
 - Climate control 156
- Temperature indicator 127
- Time display mode (Clock) 127
- Units
 - Speedometer 128
 - Temperature 127
- Setting current speed 207
- Settings
 - Convenience functions 133
 - Factory, SmartKey 83
 - Individual, SmartKey 135
 - Lighting (control system) 129
 - Menus and submenus 115
 - Resetting all (control system) 123
 - Resetting in the submenu 124
 - Selective, SmartKey 83
- Settings menu
 - Functions in 123
 - Individual vehicle settings 123
 - Submenus 124
- Shift lock 364
- Shifting
 - Gear selector lever 44
 - Gear selector lever positions 145
 - Gearshift lever 43
 - Into optimal gear range (Automatic transmission*) 143
 - Into reverse (Manual transmission) 141
- Side impact airbags 60
- Side marker lamps
 - Replacing bulbs 310, 311, 314
- Side markers
 - Cleaning 269
- Side windows
 - Automatic opening 201
 - Cleaning 270
 - Closing 200, 201, 202
 - Closing fully 201
 - Closing with SmartKey 202
 - Opening 200, 201, 202
 - Opening fully 201
 - Opening with SmartKey 202
 - Stopping 201
 - Synchronizing power windows 202
- Signal strength (telephone*) 139
- Simultaneous wiping and washing
 - Windshield wipers 48
- Single wipe 48
- Ski sack* 209
 - Installing 212
 - Removing 212
 - Unfolding and loading 209
 - Unloading and folding 211

- Sliding/pop-up roof* 203
 - Closing 203, 309
 - Closing with SmartKey 204
 - Messages in display 299
 - Opening 203, 309
 - Opening with SmartKey 204
 - Stopping 204
 - Synchronizing 205
- SmartKey 82
 - Changing batteries 307
 - Locking and unlocking 82
 - Opening and closing the sliding/pop-up roof* with 204
 - Opening and closing windows with 202
 - Unlocking with 30
- Snow chains 264
- Soft keys
 - Audio system 176
- Spare fuses 334
- Spare parts service 336
- Speed
 - Setting current 207
- Speed settings
 - Cruise control 208
- Speedometer 23
 - Settings units 128
- Speedometer display mode
 - Selecting 128
- Split rear bench seat* 212
- SRS 62, 364
 - Indicator lamp 278
 - Message in display 297
- Standing lamps 102
 - Replacing bulbs 310, 311, 313, 314
- Standing water
 - Driving instructions 245
- Starter switch 21, 31
 - Positions 31
- Starting difficulties 44
- Starting position 31
- Starting the engine 43
- Station (radio)
 - Search 119
- Station selection
 - Setting 132
- Steel rims
 - Technical data 343
- Steering column
 - Height adjustment, electrical* 38
 - Height adjustment, manual 37
 - Length adjustment, electrical* 38
 - Length adjustment, manual 37
 - Message in display 298
- Steering gear oil
 - Message in display 298
- Steering wheel
 - Adjusting 36
 - Buttons 24
 - Cleaning 271
 - Electrical adjustment* 37
 - Manual adjustment 37
- Stolen vehicle
 - Tracking services 230

Index

- Stopping
 - Sliding/pop-up roof* 204
 - Windows 201
 - Storage compartments
 - Armrest 218
 - Glove box 216
 - Ventilated compartment 160
 - Storage spaces
 - Cup holder in front
 - of seat armrest 217
 - Cup holder in rear seat armrest 218
 - Storing (Memory function*)
 - Positions into memory 100
 - Submenus
 - Convenience 133
 - For settings 115
 - In control system 117
 - Instrument cluster 126
 - Lighting 129
 - Resetting functions in
 - Control system 124
 - Selecting 124
 - Settings menu 124
 - Vehicle 132
 - Sun visors 151
 - Sunshade* 152
 - Supplemental Restraint System see SRS
 - Switching
 - Fuel (Flexible fuel vehicle) 354
 - Switching off
 - Audio system 176
 - Automatic central locking (control system) 133
 - Delayed (exterior lamps) 131
 - Engine 52
 - ESP 75
 - Hazard warning flasher 106
 - Headlamps 51
 - Rapid seat heating* 98
 - Seat heating* 98
 - Switching on
 - Audio system 176
 - Automatic central locking (control system) 133
 - ESP 76
 - Front fog lamps 105
 - Hazard warning flasher 106
 - Headlamps 46
 - High beams 106
 - Rapid seat heating* 98
 - Rear fog lamp 105
 - Seat heating* 98
 - Windshield wipers 48
- T**
- Tachometer 23, 111
 - Displaying gear range 144
 - Overspeed range 111
 - Tail lamps
 - Cleaning 269
 - Replacing bulbs 311, 315
 - Tar stains 268

- Technical data
 - Air conditioning refrigerant 352
 - Brake fluid 352
 - Coolant 350
 - Coolants 356
 - Electrical system 346
 - Engine oil additives 352
 - Engine oils 352
 - Flexible fuel vehicles 354
 - Fuel requirements 353
 - Fuels 350
 - Gasoline additives 354
 - Lubricants 349
 - Main dimensions 347
 - Premium unleaded gasoline 353
 - Rims and tires 342
 - Weights 348
 - Windshield washer 351
 - Windshield washer and headlamp cleaning* system 351, 358
- Tele Aid* 223
 - Emergency calls 224
 - Information 227
 - Initiating an emergency call manually 226
 - Message in display 299
 - Remote door unlock 230
 - Roadside assistance 226
 - SOS button 226
 - Stolen vehicle tracking services 230
 - System self-check 224
 - Tele Aid System 223, 365
 - Upgrade signals 229
- Telematics* 365
- Telephone* 24, 222
 - Answering a call 139
 - Dialing a number from the phone book 140
 - Emergency call 198
 - Ending a call 139
 - Hands-free microphone 27
- Loading phone book 140
- Message in display 299
- Operation 138, 193
- Redialing 140
- Signal strength 139
- Temperature
 - Display mode 127
 - Grades of tires 360
 - Setting interior temperature
 - Automatic climate control* 165
 - Climate control 156
 - Setting units in display 127
 - Tires 262
- Tightening torque
 - (Wheel bolts) 321, 365
- Tilt
 - Head restraint
 - Manual seat 34
 - Power seat* 36
- Time
 - Setting hours 126
 - Setting minutes 126

Index

- Time display
 - Setting 127
- Tire inflation pressure
 - Checking 251, 261
- Tire speed rating 243, 365
- Tire traction 243
- Tires 260, 342
 - Consumer information 359
 - Direction of rotation 261
 - Driving instructions 242
 - Retreads 260
 - Rims and tires 342
 - Service life 261
 - Temperature 262
 - Temperature grades 360
 - Tread depth 263
 - Wear pattern 262
 - Winter 263
- Tools 300
- Tow-away alarm* 25, 79
 - Arming 80
 - Disarming 80
 - Disarming for transport 80
- Towing eye bolt (vehicle tool kit)
 - Installing 331
- Towing the vehicle 328
- Tracking services
 - For stolen vehicle 230
- Traction 147, 359, 365
- Transmission gear selector lever
 - Unlocking manually 308
- Transmission see
 - Automatic* or Manual transmission
- Tread depth (tires) 263
- Tread Wear 359
- Trip computer 136
- Trip odometer
 - Resetting 111
- Tow-away alarm* 25, 79
- Trunk
 - Auxiliary fuse box 334
 - Closing the lid 87
 - Lamp 108
 - Opening 84
 - Opening from inside vehicle 87
 - Separately locking 89
 - Separately unlocking 90
 - Trunk lid emergency release 88
- Trunk lid
 - Closing 87
 - Emergency release 88
 - Message in display 299
- Turn signal lamps
 - Replacing bulbs 310, 311
- Turn signals 47
 - Additional in mirrors 310
 - Cleaning lenses 269
 - Front bulbs 310, 312, 314
 - Indicator lamps 23
 - Rear bulbs 311, 315
- Turning off
 - Engine 52

U

- Units
 - Setting speedometer units 128
 - Setting temperature units 127
- Unlocking 30, 82
 - Centrally from inside 91
 - Driver's door in an emergency 305
 - Fuel filler flap 249
 - Global 83
 - In an emergency 305
 - Selective settings 83
 - Separately the trunk 90
 - Transmission gear selector lever manually 308
 - Trunk in an emergency 306
 - Vehicle in an emergency 230
 - With the SmartKey 30
- Upgrade signals
 - Tele Aid* 229
- Uphill driving
 - Cruise control 207

Upholstery

- Cleaning 271
- Upshifting 143
- Useful features 216
 - Ashtrays 220
 - Cigarette lighter 221
 - Tele Aid* 223
 - Telephone* 222

V**Vehicle**

- Individual settings 123, 125
- Locking 25
- Locking in an emergency 306
- Lowering 321
- Performance in cold weather 355
- Performance in hot weather 355
- Service battery 323
- Towing 328
- Unlocking 25
- Unlocking in an emergency 305
- With flexible fuel 354

Vehicle battery 323**Vehicle care 267**

- Cloth upholstery 272
- Cup holder 271
- Engine cleaning 269
- Gear selector lever 271
- Hard plastic trim items 271
- Headlamps 269
- Instrument cluster 270
- Leather upholstery 271
- Light alloy wheels 270
- MB Tex upholstery 272
- Ornamental moldings 269
- Paintwork 268
- Plastic and rubber parts 272
- Power washer 268
- Seat belts 271
- Side markers 269
- Steering wheel 271
- Tail lamps 269
- Tar stains 268
- Turn signals 269

Index

- Upholstery 271
- Vehicle washing 269
- Window cleaning 270
- Wiper blades 270
- Wood trims 272
- Vehicle Identification Number see VIN
- Vehicle jack 301
- Vehicle lighting
 - Checking 251
- Vehicle tool kit 300
 - Alignment bolt 300
 - Removing 300
 - Spare fuses 300
 - Special fuse puller 300
 - Towing eye bolt 300
 - Vehicle jack 300
 - Wheel bolts 300
 - Wheel wrench 300
- Vehicle washing 269
- Ventilated storage compartment 160
- Ventilation
 - Storage compartment 160
- VIN 338, 365
- Voice control system* 365
 - Hands-free microphone 27
- W**
- Warning lamps
 - see Lamps, indicator and warning
- Warning sounds
 - Drivers seat belts 60
 - Parking brake 45
- Warranty coverage 337
- Washer fluid see Windshield washer fluid
- Washing the vehicle 267
- Wear pattern (tires) 262
- Weights 348
- Wheel change
 - Tightening torque 321
- Wheels
 - Rotating 262
 - Tires and wheels 260
- Window curtain airbags 60
- Windows see Side windows
- Windshield
 - Defogging
 - Automatic climate control* 166
 - Climate control 157
 - Refilling washer fluid 259
 - Replacing wiper blades 316
 - Washer fluid 259, 358
 - Washer system 358
- Windshield washer fluid 358
 - Message in display 299
 - Mixing ratio 358
 - Refilling 259
 - Wiping with 48
- Windshield washer system 358

- Windshield wipers 47, 148
 - Fast wiper speed 48
 - Replacing wiper blades 316
 - Single wipe 48
 - Switching on 48
 - Wiping with
 - windshield washer fluid 48
 - Winter driving 263
 - Block heater 264
 - Snow chains 264
 - Tires 263
 - Winter driving instructions 244
 - Winter tires 263
 - Wiper blades
 - Cleaning 270
 - Installing 316
 - Removing 316
 - Replacing 316
 - Wiping
 - Interval 48
 - With windshield washer fluid 48
 - Wood trims
 - Cleaning 272
- X**
- Xenon headlamps
 - Bi-Xenon* 361



Service and Literature

Your authorized Mercedes-Benz Center has trained technicians and original Mercedes-Benz parts to service your vehicle properly.
For expert advice and quality service, see your authorized Mercedes-Benz Center.

If you are interested in obtaining service literature for your vehicle, please contact your authorized Mercedes-Benz Center.
We consider this the best way for you to obtain accurate information for your vehicle.

For further information you can find us on the Mercedes-Benz web-site www.mbusa.com or www.mercedes-benz.ca.

Warning!



To help avoid personal injury, be extremely careful when performing any service work or repairs. Improper or incomplete service or the use of incorrect or inappropriate parts or materials may damage the vehicle or its equipment, which may in turn result in personal injury.

If you have questions about carrying out any type of service, turn to the advice of an authorized Mercedes-Benz Center.

We reserve the right to modify the technical details of the vehicle as given in the data and illustrations of this Operator's Manual.
Reprinting, translation and copying, even of excerpts, is not permitted without our prior authorization in writing.

Title illustration no. P00.01-2283-31

Press time 08/14/03

GSP/TIP

Printed in Germany

